

## Operating Instructions

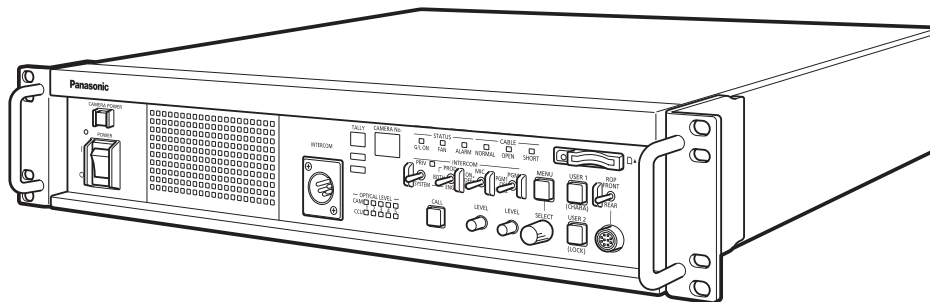

Camera Control Unit

Model No. **AK-UCU600P**  
Model No. **AK-UCU600PS**  
Model No. **AK-UCU600E**  
Model No. **AK-UCU600ES**



Please carefully read this manual, and save this manual for future use.  
Before using this product, be sure to read "Read this first!" (pages 2 to 6).

**Read this first!**

	<b>CAUTION</b> <b>RISK OF ELECTRIC SHOCK</b> <b>DO NOT OPEN</b>	
CAUTION: TO REDUCE THE RISK OF ELECTRIC SHOCK, DO NOT REMOVE COVER (OR BACK). NO USER-SERVICEABLE PARTS INSIDE. REFER TO SERVICING TO QUALIFIED SERVICE PERSONNEL.		



The lightning flash with arrowhead symbol, within an equilateral triangle, is intended to alert the user to the presence of uninsulated "dangerous voltage" within the product's enclosure that may be of sufficient magnitude to constitute a risk of electric shock to persons.



The exclamation point within an equilateral triangle is intended to alert the user to the presence of important operating and maintenance (servicing) instructions in the literature accompanying the appliance.

**WARNING:**

This equipment must be grounded. To ensure safe operation, the three-pin plug must be inserted only into a standard three-pin power outlet which is effectively grounded through normal household wiring.

Extension cords used with the equipment must have three cores and be correctly wired to provide connection to the ground. Wrongly wired extension cords are a major cause of fatalities.

The fact that the equipment operates satisfactorily does not imply that the power outlet is grounded or that the installation is completely safe. For your safety, if you are in any doubt about the effective grounding of the power outlet, please consult a qualified electrician.

**WARNING:**

- To reduce the risk of fire or electric shock, do not expose this equipment to rain or moisture.
- To reduce the risk of fire or electric shock, keep this equipment away from all liquids. Use and store only in locations which are not exposed to the risk of dripping or splashing liquids, and do not place any liquid containers on top of the equipment.

**WARNING:**

Always keep memory cards (optional accessory) out of the reach of babies and small children.

**WARNING:**

Installation should only be performed by qualified installation personnel. Improper installation may result in the entire apparatus falling down and causing injury.

**CAUTION:**

To reduce the risk of fire or electric shock and annoying interference, use the recommended accessories only.

**CAUTION:**

In order to maintain adequate ventilation, do not install or place this unit in a bookcase, built-in cabinet or any other confined space. To prevent risk of electric shock or fire hazard due to overheating, ensure that curtains and any other materials do not obstruct the ventilation.

**CAUTION:**

The mains plug of the power supply cord shall remain readily operable. The AC receptacle (mains socket outlet) shall be installed near the equipment and shall be easily accessible. To completely disconnect this equipment from the AC mains, disconnect the power cord plug from the AC receptacle.

**CAUTION:**

Invisible Laser radiation is emitted from the Optical fiber connector when this product is turned on. Don't look into directly into the Optical fiber connector of this product.

**CAUTION:**

This product uses a semiconductor laser system and is a Class 1 Laser Product complies with Radiation Performance Standards, 21CFR SUBCHAPTER J. Use of controls or adjustments or performance of procedures other than those specified herein may result in hazardous radiation exposure. Don't make any modifications. Don't repair by yourself. Refer servicing to qualified personnel.

**CAUTION:**

- Keep the temperature inside the rack to between 0 °C to 40 °C (32 °F to 104 °F).
- Bolt the rack securely to the floor so that it will not topple over when the unit is drawn out.

**CAUTION:**

Naked flame sources, such as lighted candles, should not be placed on the apparatus.

**CAUTION:**

To reduce the risk of fire or electric shock, refer mounting of the optional interface boards to qualified service personnel.

**NOTIFICATION (Canada)**

**CAN ICES-003 (A)/NMB-003(A)**

 indicates safety information.

For AK-UCU600P, AK-UCU600PS

## IMPORTANT SAFETY INSTRUCTIONS

- 1) Read these instructions.
- 2) Keep these instructions.
- 3) Heed all warnings.
- 4) Follow all instructions.
- 5) Do not use this apparatus near water.
- 6) Clean only with dry cloth.
- 7) Do not block any ventilation openings. Install in accordance with the manufacturer's instructions.
- 8) Do not install near any heat sources such as radiators, heat registers, stoves, or other apparatus (including amplifiers) that produce heat.
- 9) Do not defeat the safety purpose of the polarized or grounding-type plug. A polarized plug has two blades with one wider than the other. A grounding-type plug has two blades and a third grounding prong. The wide blade or the third prong are provided for your safety. If the provided plug does not fit into your outlet, consult an electrician for replacement of the obsolete outlet.
- 10) Protect the power cord from being walked on or pinched particularly at plugs, convenience receptacles, and the point where they exit from the apparatus.
- 11) Only use attachments/accessories specified by the manufacturer.
- 12) Use only with the cart, stand, tripod, bracket, or table specified by the manufacturer, or sold with the apparatus. When a cart is used, use caution when moving the cart/apparatus combination to avoid injury from tip-over.
- 13) Unplug this apparatus during lightning storms or when unused for long periods of time.
- 14) Refer all servicing to qualified service personnel. Servicing is required when the apparatus has been damaged in any way, such as power-supply cord or plug is damaged, liquid has been spilled or objects have fallen into the apparatus, the apparatus has been exposed to rain or moisture, does not operate normally, or has been dropped.



### FCC NOTICE (USA)

This device complies with part 15 of the FCC Rules.

Operation is subject to the following two conditions:

(1) This device may not cause harmful interference, and (2) this device must accept any interference received, including interference that may cause undesired operation.

#### CAUTION:

This equipment has been tested and found to comply with the limits for a class A digital device, pursuant to Part 15 of the FCC Rules. These limits are designed to provide reasonable protection against harmful interference when the equipment is operated in a commercial environment. This equipment generates, uses, and can radiate radio frequency energy and, if not installed and used in accordance with the instruction manual, may cause harmful interference to radio communications. Operation of this equipment in a residential area is likely to cause harmful interference in which case the user will be required to correct the interference at his own expense.

#### FCC Warning:

To assure continued FCC emission limit compliance, the user must use only shielded interface cables when connecting to external units. If DVI-D port is to be used it must be connected to PC by compatible interface cable with two ferrite cores. Also, any unauthorized changes or modifications to this equipment could void the user's authority to operate it.

 indicates safety information.

For AK-UCU600E, AK-UCU600ES

## Caution for AC Mains Lead

**FOR YOUR SAFETY PLEASE READ THE FOLLOWING TEXT CAREFULLY.**

This product is equipped with 2 types of AC mains cable. One is for continental Europe, etc. and the other one is only for U.K.

Appropriate mains cable must be used in each local area, since the other type of mains cable is not suitable.

### FOR CONTINENTAL EUROPE, ETC.

Not to be used in the U.K.

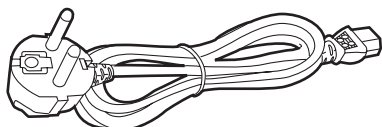

### FOR U.K. ONLY

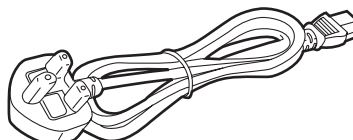

If the plug supplied is not suitable for your socket outlet, it should be cut off and appropriate one fitted.



### FOR U.K. ONLY

This appliance is supplied with a moulded three pin mains plug for your safety and convenience.

A 13 amp fuse is fitted in this plug.

Should the fuse need to be replaced please ensure that the replacement fuse has a rating of 13 amps and that it is approved by ASTA or BSI to BS1362. Check for the ASTA mark  or the BSI mark  on the body of the fuse.

If the plug contains a removable fuse cover you must ensure that it is refitted when the fuse is replaced.

If you lose the fuse cover the plug must not be used until a replacement cover is obtained.

A replacement fuse cover can be purchased from your local Panasonic Dealer.

### How to replace the fuse

1. Open the fuse compartment with a screwdriver.

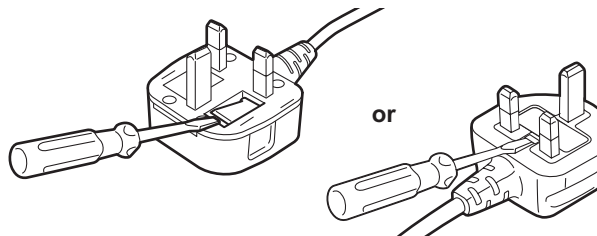

2. Replace the fuse.

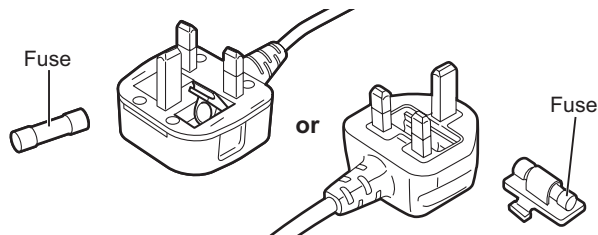

 indicates safety information.



## EMC NOTICE FOR THE PURCHASER/USER OF THE APPARATUS

### 1. Pre-requisite conditions to achieving compliance with the above standards

#### <1> Peripheral equipment to be connected to the apparatus and special connecting cables

- The purchaser/user is urged to use only equipment which has been recommended by us as peripheral equipment to be connected to the apparatus.
- The purchaser/user is urged to use only the connecting cables described below.

#### <2> For the connecting cables, use shielded cables which suit the intended purpose of the apparatus.

- Video signal connecting cables  
Use double-shielded coaxial cables, which are designed for 75-ohm type high-frequency applications, for SDI (Serial Digital Interface).  
Coaxial cables, which are designed for 75-ohm type high-frequency applications, are recommended for analog video signals.
- Audio signal connecting cables  
If your apparatus supports AES/EBU serial digital audio signals, use cables designed for AES/EBU.  
Use shielded cables, which provide quality performance for high-frequency transmission applications, for analog audio signals.
- Other connecting cables (LAN, RS-422)  
Use double shielded cables, which provide quality performance for high-frequency applications, as connecting cables.
- When connecting to the DVI signal terminal, use a cable with a ferrite core.
- If your apparatus is supplied with ferrite core(s), they must be attached on cable(s) following instructions in this manual.

### 2. Performance level

The performance level of the apparatus is equivalent to or better than the performance level required by these standards.

However, the apparatus may be adversely affected by interference if it is being used in an EMC environment, such as an area where strong electromagnetic fields are generated (by the presence of signal transmission towers, cellular phones, etc.). In order to minimize the adverse effects of the interference on the apparatus in cases like this, it is recommended that the following steps be taken with the apparatus being affected and with its operating environment:

1. Place the apparatus at a distance from the source of the interference.
2. Change the direction of the apparatus.
3. Change the connection method used for the apparatus.
4. Connect the apparatus to another power outlet where the power is not shared by any other appliances.

**AEEE Yönetmeliğine Uygundur.**  
**AEEE Complies with Directive of Turkey.**

**Manufactured by:**

Panasonic Connect Co., Ltd.  
4-1-62 Minoshima, Hakata-ku, Fukuoka 812-8531, Japan

**Importer:**

Panasonic Connect Europe GmbH  
Hagenauer Strasse 43, 65203 Wiesbaden, Germany

**Authorized Representative in EU:**

Panasonic Connect Europe GmbH  
Panasonic Testing Centre  
Winsbergring 15, 22525 Hamburg, Germany

**Importer for UK:**

Panasonic Connect UK,  
a branch of Panasonic Connect Europe GmbH,  
Maxis 2, Western Road, Bracknell, Berkshire, RG12 1RT

**Disposal of Old Equipment****Only for European Union and countries with recycling systems**

This symbol on the products, packaging, and/or accompanying documents means that used electrical and electronic products must not be mixed with general household waste.

For proper treatment, recovery and recycling of old products, please take them to applicable collection points in accordance with your national legislation.

By disposing of them correctly, you will help to save valuable resources and prevent any potential negative effects on human health and the environment. For more information about collection and recycling, please contact your local municipality, dealer or supplier.

Penalties may be applicable for incorrect disposal of this waste, in accordance with national legislation.

**ІНФОРМАЦІЯ ПРО ПІДТВЕРДЖЕННЯ ВІДПОВІДНОСТІ ПРОДУКТУ**

Виробник:	Panasonic Connect Co., Ltd.	Панасонік Коннект Ко., Лтд.
Адреса виробника:	Fukuoka, Japan	Фукуока Японія
Країна походження:	Japan	Японія

Імпортер:	ТОВ "ПАНАСОНІК УКРАЇНА ЛТД"
Адреса Імпортера:	вул. Васильківська, буд. 30, м. Київ, 03022, Україна

**Примітки:**

Термін служби виробу	7 років
----------------------	---------

Дату виготовлення можна визначити за комбінацією букв і цифр серійного номера, що розташований на маркувальній табличці виробу.

**Приклад:**

X X XXXXXXX

Рік: остання цифра року (6 – 2016, 7 – 2017, ... 0 – 2020)
Місяць: А – Січень, В – Лютий... L – Грудень

# Table of Contents

<b>Read this first!</b> .....	<b>2</b>	HD PHASE .....	<b>69</b>
<b>Introduction</b> .....	<b>9</b>	SD PHASE.....	<b>69</b>
How to View This Manual .....	<b>9</b>	BAR ID .....	<b>74</b>
About trademarks and registered trademarks .....	<b>9</b>	SELECT RETURN .....	<b>75</b>
About copyright.....	<b>9</b>	MONITOR.....	<b>76</b>
Illustrations and screen displays featured in the manual .....	<b>9</b>	SETTING(MOIP).....	<b>77</b>
Overview.....	<b>10</b>	UHD SETTING .....	<b>78</b>
Notice.....	<b>11</b>	UHD DETAIL.....	<b>78</b>
Personal computer requirements.....	<b>11</b>	UHD SKIN TONE DETAIL(1/2).....	<b>79</b>
Disclaimer of warranty .....	<b>11</b>	UHD SKIN TONE DETAIL(2/2).....	<b>80</b>
Network security .....	<b>12</b>	UHD CHROMA .....	<b>80</b>
Memory cards .....	<b>12</b>	HD DETAIL(1/2).....	<b>81</b>
Features.....	<b>13</b>	HD DETAIL(2/2).....	<b>82</b>
Accessories .....	<b>14</b>	HD SKIN TONE DTL(1/2).....	<b>83</b>
Precautions for Use .....	<b>15</b>	HD SKIN TONE DTL(2/2).....	<b>84</b>
Precautions for Installation .....	<b>16</b>	HD CHROMA.....	<b>84</b>
Mounting the unit in a rack.....	<b>17</b>	AUDIO .....	<b>85</b>
<b>Connection</b> .....	<b>18</b>	MIC OUT.....	<b>85</b>
System configuration .....	<b>18</b>	CCU INTERCOM TALK .....	<b>86</b>
Serial connection .....	<b>18</b>	CCU INTERCOM RECEIVE .....	<b>86</b>
IP connection .....	<b>18</b>	STBY INTERCOM .....	<b>87</b>
Equipment connections .....	<b>19</b>	COMMUNICATION.....	<b>87</b>
<b>Parts and their functions</b> .....	<b>20</b>	INTERCOM1.....	<b>88</b>
Front panel 1.....	<b>20</b>	INTERCOM2.....	<b>89</b>
Front panel 2.....	<b>21</b>	PGM.....	<b>90</b>
Front panel 3.....	<b>22</b>	FORMAT(MOIP) .....	<b>91</b>
Rear panel 1 .....	<b>23</b>	MAINTENANCE.....	<b>92</b>
Rear panel 2 .....	<b>25</b>	START UP.....	<b>93</b>
Rear panel 3 (with AK-NP600 option).....	<b>26</b>	SETUP .....	<b>93</b>
<b>Picture monitor (PM)</b> .....	<b>27</b>	AUX .....	<b>95</b>
Picture monitor displays.....	<b>27</b>	ANALOG GAIN .....	<b>96</b>
Transition of displays .....	<b>28</b>	ND/CC NAME(1/2).....	<b>96</b>
Information display.....	<b>29</b>	ND/CC NAME(2/2).....	<b>97</b>
Warning displays.....	<b>29</b>	NETWORK(1/2) .....	<b>98</b>
IRIS display.....	<b>30</b>	NETWORK(2/2) .....	<b>98</b>
Status displays.....	<b>31</b>	NETWORK(MOIP) .....	<b>99</b>
Operation displays.....	<b>38</b>	VERSION.....	<b>111</b>
Auto displays .....	<b>39</b>	PM VIEW SETTING(1/2) .....	<b>112</b>
<b>CCU menu</b> .....	<b>40</b>	PM VIEW SETTING(2/2) .....	<b>113</b>
Menu operations.....	<b>40</b>	PM OPERATION STATUS.....	<b>114</b>
Displaying and hiding the menus.....	<b>41</b>	SYSTEM.....	<b>115</b>
Basic menu operations .....	<b>42</b>	SD CARD.....	<b>117</b>
Operation with menu items that have multiple setting items on one line .....	<b>44</b>	Saving and loading reference files and scene files .....	<b>118</b>
Text input .....	<b>45</b>	<b>Web Screen</b> .....	<b>119</b>
CCU MENU .....	<b>47</b>	Network settings .....	<b>119</b>
OPERATION.....	<b>48</b>	Software.....	<b>119</b>
SYSTEM MODE .....	<b>49</b>	Using Easy IP Setup Software to set the unit's settings .....	<b>119</b>
OUT FORMAT(UHD).....	<b>55</b>	Installing the plug-in viewer software .....	<b>121</b>
OUT FORMAT(HS).....	<b>57</b>	Displaying the web screen.....	<b>122</b>
OUT FORMAT(HD).....	<b>58</b>	Notice regarding the Web screen .....	<b>122</b>
OUT FORMAT(UHD_HDR) .....	<b>60</b>	Displaying the web screen using a personal computer.....	<b>122</b>
OUT FORMAT(HS_HDR).....	<b>62</b>	Switching the [Live] screen or [Setup] screen.....	<b>124</b>
OUT FORMAT(HD_HDR).....	<b>64</b>	[Live] screen .....	<b>125</b>
SETTING(1/2).....	<b>67</b>	Parts and their functions ([Live] screen) .....	<b>126</b>
SETTING(2/2).....	<b>68</b>	[Setup] screen.....	<b>129</b>
		Logging into the [Setup] screen .....	<b>129</b>
		Parts and their functions ([Setup] screen) .....	<b>130</b>
		[Basic] screen .....	<b>131</b>
		[Image] screen .....	<b>132</b>
		[User mng.] screen .....	<b>139</b>

---

[Network] screen .....	141
[Maintenance] screen .....	145
<b>Web Screen (AK-NP600) .....</b>	<b>147</b>
Network settings .....	147
Software .....	147
Using EasyIP Setup Tool Plus to set the unit's settings .....	147
Displaying the web screen (AK-NP600) .....	149
Notice regarding the Web screen .....	149
Displaying the web screen using a personal computer .....	149
Logging into the web screen .....	152
Web setting screen .....	152
Product information screen [Product info.] .....	153
View system settings screen [System mode] .....	154
Network settings screen [Network] .....	158
User management screen [User mng.] .....	170
<b>Troubleshooting .....</b>	<b>171</b>
Operation .....	171
IP Images .....	173
Web Screen .....	175
<b>Reference .....</b>	<b>176</b>
Connector pin assignment table .....	176
Front panel .....	176
Rear panel .....	176
Front panel [G/L ON] indicator specifications .....	183
Appearance .....	184
<b>Specifications .....</b>	<b>185</b>
<b>Index .....</b>	<b>187</b>

---

# Introduction

---

## How to View This Manual

---

### About trademarks and registered trademarks

- Microsoft®, Windows®, Windows® 7, Windows® 8, Windows® 8.1, Windows® 10, Internet Explorer®, ActiveX® and DirectX® are either registered trademarks or trademarks of Microsoft Corporation in the United States and other countries.
- Apple, Mac and OS X are registered trademarks of Apple Inc., in the United States and other countries.
- Intel® and Intel® Core™ are trademarks or registered trademarks of Intel Corporation and its subsidiaries in the United States and other countries.
- SDXC logo is a trademark of SD-3C and LLC.
- Other names of companies or products in this manual are either registered trademarks or trademarks of their respective owners.

### About copyright

Distributing, copying, disassembling, reverse compiling, reverse engineering and also exporting in violation of export laws of the software provided with this unit are expressly prohibited.

### Illustrations and screen displays featured in the manual

- What is shown in the manual's illustrations and screen displays may differ from how it actually appears.
- The screenshots are used in accordance with the guidelines of Microsoft Corporation.
- Functions which can be used by Windows only are indicated using [Windows].

---

## Overview

---

This camera control unit (CCU) is designed to be used with the 4K studio camera (AK-UC4000; sold separately, AK-UC3000; sold separately, AK-UC3300; sold separately, AK-PLV100; sold separately).

Connect it to the 4K studio camera (hereinafter referred to as the camera) with an optical fiber multi cable (sold separately).

You can use the unit to input and output the video signals of various formats.\*1

The unit supports 12G/6G/3G-HD/HD-SDI outputs, analog composite outputs, HD/SD-SDI return inputs, VBS return inputs, and prompter inputs (HD-SDI, analog composite).

The unit is equipped with an HD-TRUNK/TICO output, LAN-TRUNK connector\*2, and TRUNK connector.

Intercom calls with the camera and microphone audio output are possible.

The unit also comes with tally and other system interface inputs.

Connecting the ROP (AK-HRP1000; sold separately, AK-HRP1005; sold separately, AK-HRP1010; sold separately, AK-HRP1015; sold separately, AK-HRP250; sold separately) with a multi cable (sold separately) allows you to use the ROP to control the adjustment and setting of the camera and this unit.

\*1: Configure the format and imaging mode settings on the camera according to the format setting of the CCU.

\*2: This cannot be used with UHD mode and HS mode.

## Notice

### Personal computer requirements

Use a host computer that satisfies the following conditions.

<b>CPU</b>	CPU Intel® Core™2 DUO 2.4 GHz or better is recommended
<b>Memory</b>	<ul style="list-style-type: none"> <li>• <b>Windows</b> 1 GB or more (However, 2 GB or more for the 64-bit versions of Microsoft® Windows® 10, Microsoft® Windows® 8.1, Microsoft® Windows® 8, and Microsoft® Windows® 7)</li> <li>• <b>Mac</b> 2 GB or more</li> </ul>
<b>Network function</b>	100BASE-TX 1 port
<b>Image display function</b>	Resolution: 1024×768 pixels or more Color generation: True Color 24-bit or better
<b>Supported operating systems and Web browser</b>	<ul style="list-style-type: none"> <li>• <b>Windows</b> <ul style="list-style-type: none"> <li>• Microsoft® Windows® 10 Pro 64-bit/32-bit*1</li> <li>• Microsoft® Windows® 8.1 Pro 64-bit/32-bit*1</li> <li>• Windows® Internet Explorer® 11.0*1*3</li> <li>• Microsoft® Windows® 8 Pro 64-bit/32-bit*1</li> <li>• Windows® Internet Explorer® 10.0*1*3</li> <li>• Microsoft® Windows® 7 Professional SP1 64-bit/32-bit*2</li> <li>• Windows® Internet Explorer® 11.0/10.0/9.0/8.0*3</li> </ul> </li> <li>• <b>Mac</b> <ul style="list-style-type: none"> <li>• OS X 10.12 Safari 10</li> <li>• OS X 10.11 Safari 9</li> <li>• OS X 10.10 Safari 8.0.4</li> <li>• OS X 10.9 Safari 7.0.2</li> <li>• OS X 10.8 Safari 6.1.2</li> </ul> </li> </ul>

\*1: Use the desktop version of Internet Explorer. (Internet Explorer for Windows UI is not supported.)

\*2: Use is not possible in Windows® XP compatibility mode.

\*3: Use is not possible with the 64-bit version of Internet Explorer®.

### Disclaimer of warranty

IN NO EVENT SHALL Panasonic Connect Co., Ltd. BE LIABLE TO ANY PARTY OR ANY PERSON, EXCEPT FOR REPLACEMENT OR REASONABLE MAINTENANCE OF THE PRODUCT, FOR THE CASES, INCLUDING BUT NOT LIMITED TO BELOW:

- ANY DAMAGE AND LOSS, INCLUDING WITHOUT LIMITATION, DIRECT OR INDIRECT, SPECIAL, CONSEQUENTIAL OR EXEMPLARY, ARISING OUT OF OR RELATING TO THE PRODUCT;
- PERSONAL INJURY OR ANY DAMAGE CAUSED BY INAPPROPRIATE USE OR NEGLIGENT OPERATION OF THE USER;
- UNAUTHORIZED DISASSEMBLE, REPAIR OR MODIFICATION OF THE PRODUCT BY THE USER;
- INCONVENIENCE OR ANY LOSS ARISING WHEN IMAGES ARE NOT DISPLAYED, DUE TO ANY REASON OR CAUSE INCLUDING ANY FAILURE OR PROBLEM OF THE PRODUCT;
- ANY PROBLEM, CONSEQUENTIAL INCONVENIENCE, OR LOSS OR DAMAGE, ARISING OUT OF THE SYSTEM COMBINED BY THE DEVICES OF THIRD PARTY;
- ANY INCONVENIENCE, DAMAGES OR LOSSES RESULTING FROM ACCIDENTS CAUSED BY AN INADEQUATE INSTALLATION METHOD OR ANY FACTORS OTHER THAN A DEFECT IN THE PRODUCT ITSELF;
- LOSS OF REGISTERED DATA CAUSED BY ANY FAILURE;
- ANY DAMAGE OR CLAIMS DUE TO LOSS OR LEAKAGE OF IMAGE DATA OR SETTING DATA SAVED ON THIS UNIT OR ON A MEMORY CARD OR PERSONAL COMPUTER.

## Network security

This unit also has functions which are used when it is connected to a network.

Using the unit when it is connected to a network may possibly give rise to the following.

- Leakage or disclosure of information transmitted via this unit
- Unauthorized use of this unit by a third person with malicious intent
- Interference or stoppage of this unit by a third person with malicious intent

It is your responsibility to take sufficient network security measures such as those described below to protect yourself against the above risks.

- Use this unit in a network secured by a firewall, etc.
- If this unit is used in a system with a personal computer connected, make sure that checks for and removal of computer viruses and malicious programs are implemented regularly.

Also observe the following points.

- Do not install the unit in a location where the unit, cables, and other parts may be easily damaged.

## Memory cards

Memory cards used with the unit should conform to SD, SDHC or SDXC standards.

Be sure to use the unit to format memory cards.

Memory cards with the following capacity can be used with the unit.

SD:	2 GB
SDHC:	4 GB to 32 GB
SDXC:	64 GB

For the latest information not included in these Operating Instructions, refer to the support pages at the following website.

<https://pro-av.panasonic.net/en/>

Observe the following points when using and storing this unit.

- Avoid high temperature and humidity.
- Avoid water droplets.
- Avoid static electricity.



---

## Features

---

### ■ 4K and HD format simultaneous operation possible (when using AK-UC4000)

As a standard feature, this unit incorporates 4K video (UHD) output, HD high speed video output, HD video signal output, and analog composite video signals that are available when this unit is used in combination with AK-UC4000.

### NOTE

---

- Analog composite image output is not available with the AK-NP600 option.

### ■ BAR ID display

Characters can be displayed on the color bar signals so as to identify the output source of the images, and then output.

### ■ Prompter



As a standard feature, the unit incorporates prompter input. (HD-SDI×1, Analog composite×2)

### ■ MoIP (with AK-NP600 option)

Using the AK-NP600 option allows for SMPTE ST2110-compliant MoIP.

## Accessories

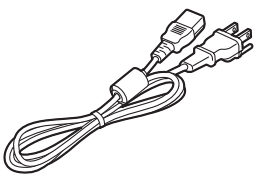
- After removing the product from its container, dispose of the power cable cap (if supplied) and packing materials in an appropriate manner.

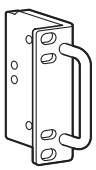
<p>Power cable</p> <ul style="list-style-type: none"><li>• for AK-UCU600P / AK-UCU600PS.....1</li></ul>  <ul style="list-style-type: none"><li>• for AK-UCU600E / AK-UCU600ES.....2</li></ul> 	<p>Rack mount adapters*1.....2</p> <p>➔ "Mounting the rack mount adapters" (see page 17)</p> 
--	--

\*1: The screws for the rack mount adapters come attached to the unit.

## Precautions for Use

In addition to the safety precautions given in "Read this first!", also observe the following instructions.

### ■ Handle carefully

- Do not drop the product or subject it to a strong impact. Doing so may cause a failure or accident.

### ■ Avoid using the unit outdoors

- Use the product in an ambient temperature of 0 °C to 40 °C (32 °F to 104 °F). Avoid using the product in a cold place where the temperature drops below 0 °C (32 °F) or in a hot place where the temperature rises above 40 °C (104 °F) because an extremely low or high temperature will adversely affect the internal parts.

### ■ Turn off the power before connecting or disconnecting cables

- Before connecting or disconnecting the cables, be sure to turn the power off.

### ■ Avoid humidity and dust

- Avoid using the product in a very humid or dusty place because a lot of humidity and dust will cause damage to the internal parts.

### ■ Cleaning

- Turn the power off and wipe the product with a dry cloth.
- To remove stubborn dirt, dip a cloth into a diluted solution of kitchen detergent (neutral detergent), wring it out well, and wipe the product gently. Then, wipe the product with a cloth dampened with water. Finally, wipe the product with a dry cloth.



#### NOTE

- Avoid using benzine, paint thinners and other volatile fluids.
- If a chemical cleaning cloth is to be used, carefully read through the precautions for its use.

### ■ Optical fiber multi cable

- When the optical fiber connectors of the optical fiber multi cable (sold separately) become dirty, the optical signal transmission state will deteriorate. Use commercially available optical connector cleaner to clean the optical connector end faces in accordance with the instructions.

### ■ Consumable parts

- The cooling fan is a consumable part. The replacement cycle is approximately 10 years (when used approximately 8 hours per day).  
Contact your dealer to request cooling fan replacement.

### ■ Disposal of the unit

- When the unit has reached the end of its service life and is to be disposed of, ask a qualified contractor to dispose of the unit properly in order to protect the environment.

#### ■ Information on software used with this product

This product includes GNU General Public License (GPL) and GNU Lesser General Public License (LGPL) licensed software, and the customer is entitled to obtain, modify, or redistribute the source code for the software.

- This product includes MIT Licensed software.
- This product includes BSD Licensed software.
- For details on obtaining the source codes, visit the following website.

<https://pro-av.panasonic.net/en/>

However, do not contact Panasonic for questions regarding obtained source codes.

## Precautions for Installation

In addition to the safety precautions given in "Read this first!", also observe the following instructions.

Be sure to ask your dealer to perform the installation and connection work for the unit.

### ■ Connecting a power supply

- Be sure to use the power cable supplied with the unit.
- Connect the [SIGNAL GND] terminal on the rear of the unit to the system ground.
- When the unit will not be used for a long time, turn off the [POWER] switch and remove the power plug from the outlet to save power.

### ■ Ground of the power plug

- The power cable supplied with the unit has a 3-prong plug with a ground terminal. Connect it to a 3-prong outlet with a ground contact.

### ■ Grounding

- Ground the system via the [SIGNAL GND] terminal on the unit.

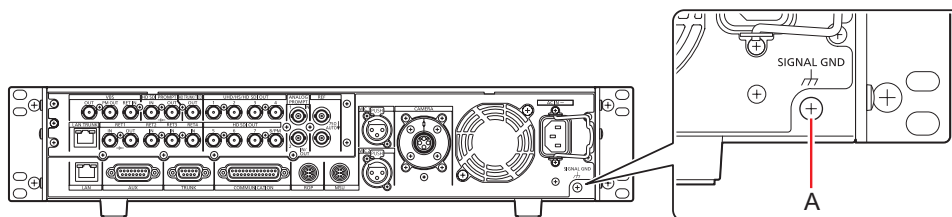

A. [SIGNAL GND] terminal

### ■ Handle carefully

- Dropping the unit or subjecting it to a strong impact or vibration may cause a failure or accident.
- Do not allow any foreign objects to enter inside the unit.  
Allowing water, metal items, food or drink, or other foreign objects to enter inside the unit may cause a fire or electric shock.

### ■ Installation location

- This unit is designed for indoor use only.
- Do not install the unit in a cold place where the temperature drops below 0 °C (32 °F) or in a hot place where the temperature rises above 40 °C (104 °F).
- Avoid installing the unit where it will be exposed to direct sunlight or near an outlet from which hot air is blown out.
- Installing the unit in a location with a lot of humidity, dust, or vibration may result in a failure.

## Mounting the unit in a rack

### Mounting the rack mount adapters

1. **Remove the setting legs (A) secured to the unit.**  
Remove them using a Phillips screwdriver.
2. **Mount the supplied rack mount adapters (B).**
  - Mounting screws are not supplied. Use mounting screws removed from the unit using a Phillips screwdriver.
  - Tighten the mounting screws for rack mount adapters using a torque of 110 N·m or more.

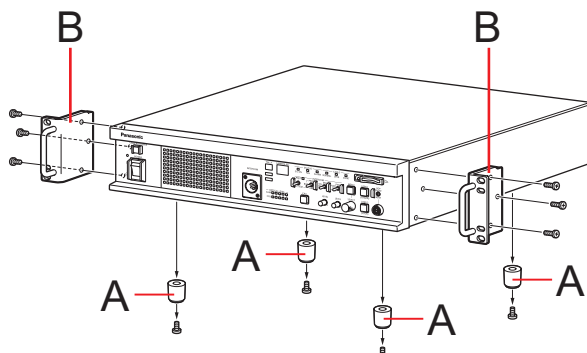

**A. Setting legs**

**B. Rack mount adapters**

### Mounting the unit in a rack

- Use the unit securely mounted in a standard 19-type rack (depth: 600 mm [23-5/8 inches] or more) compliant with EIA or JIS standards or equivalent.
- Securely fix the unit in place using screws that are appropriate for the rack.
- Be sure to attach a support guide for supporting (A) the rear of the unit.  
(Provide a support guide that is appropriate for the rack.)

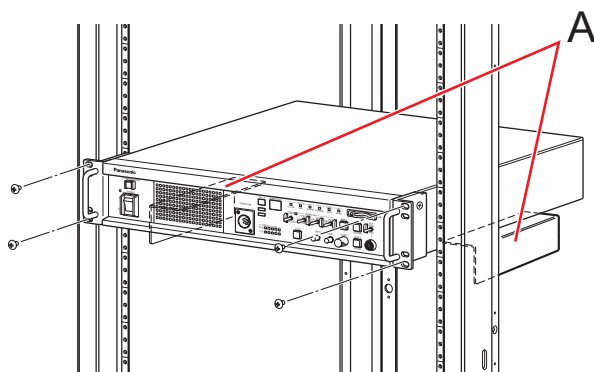

A. Support guide

### Mounting positions

In the case of the EIA standard rack

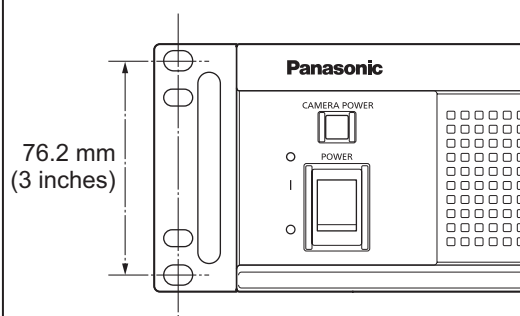

In the case of the JIS standard rack

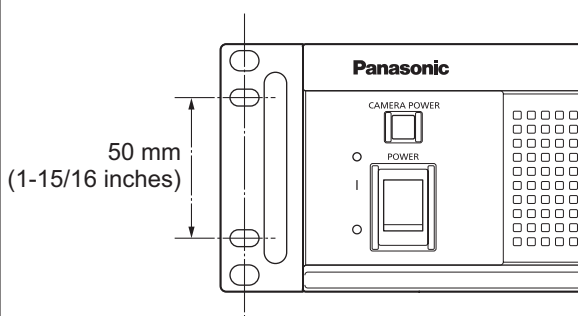

### NOTE

- Do not block the ventilation holes when installing the unit.

# Connection

## System configuration

### Serial connection

Use the optical fiber multi cable (sold separately) to connect the unit and camera.

Use a ROP cable to connect the unit to the ROP (AK-HRP1000 / AK-HRP1005 / AK-HRP1010 / AK-HRP1015 / AK-HRP250).

For the connection procedure, see "Equipment connections."

➔ "Equipment connections" (see page 19)

Camera:

AK-UC4000 / AK-UC3000 / AK-UC3300 / AK-PLV100

ROP :

AK-HRP1000 /  
AK-HRP1005 /  
AK-HRP1010 /  
AK-HRP1015 /  
AK-HRP250

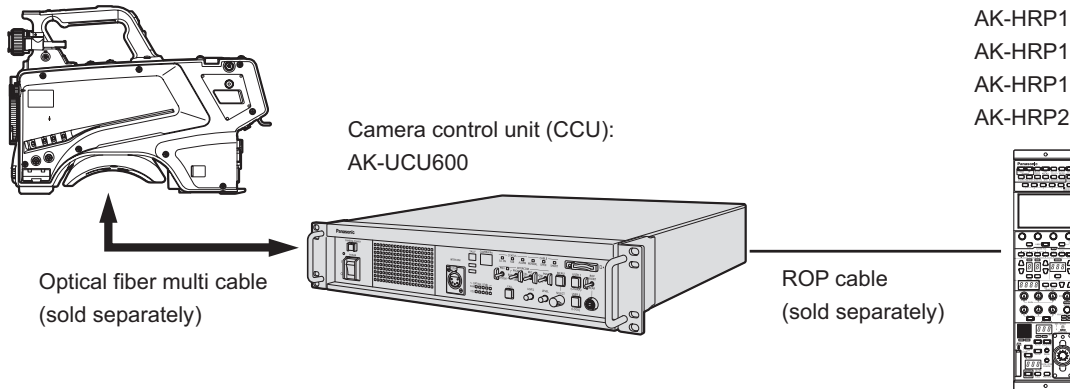

### IP connection

Use the optical fiber multi cable (sold separately) to connect the unit and camera.

Connect the unit to the ROP (AK-HRP1000 / AK-HRP1005 / AK-HRP1010 / AK-HRP1015 / AK-HRP250) via a PoE-compatible switching hub using LAN cables (straight cables: sold separately).

- Read "Network security" before connecting the devices.
- Use a switching hub with PoE support.

For the connection procedure, see "Equipment connections."

➔ "Equipment connections" (see page 19)

Camera:

AK-UC4000 / AK-UC3000 / AK-UC3300 / AK-PLV100

ROP :

AK-HRP1000 /  
AK-HRP1005 /  
AK-HRP1010 /  
AK-HRP1015 /  
AK-HRP250

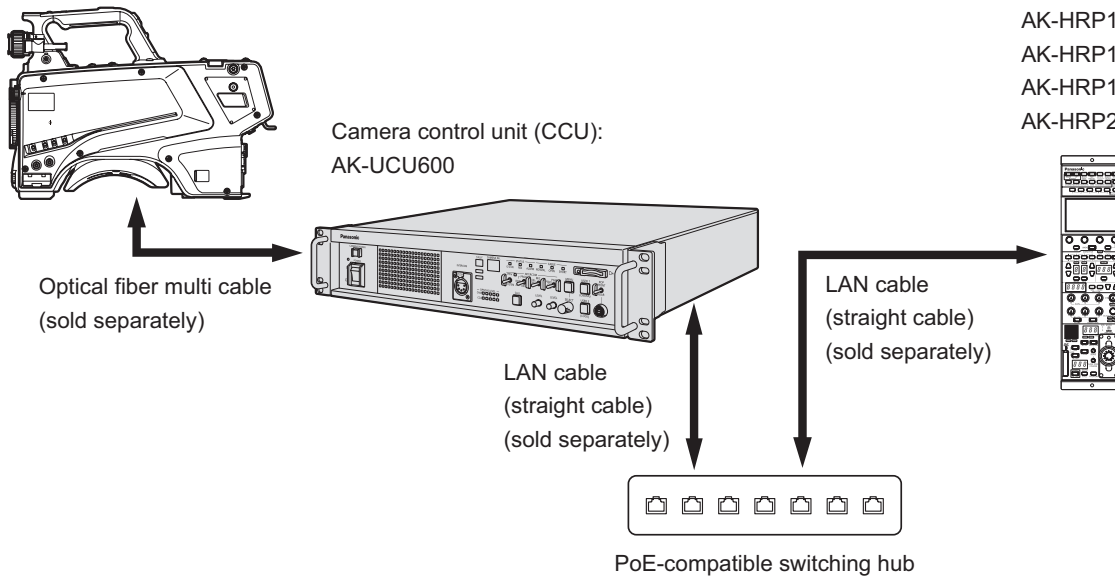

## Equipment connections

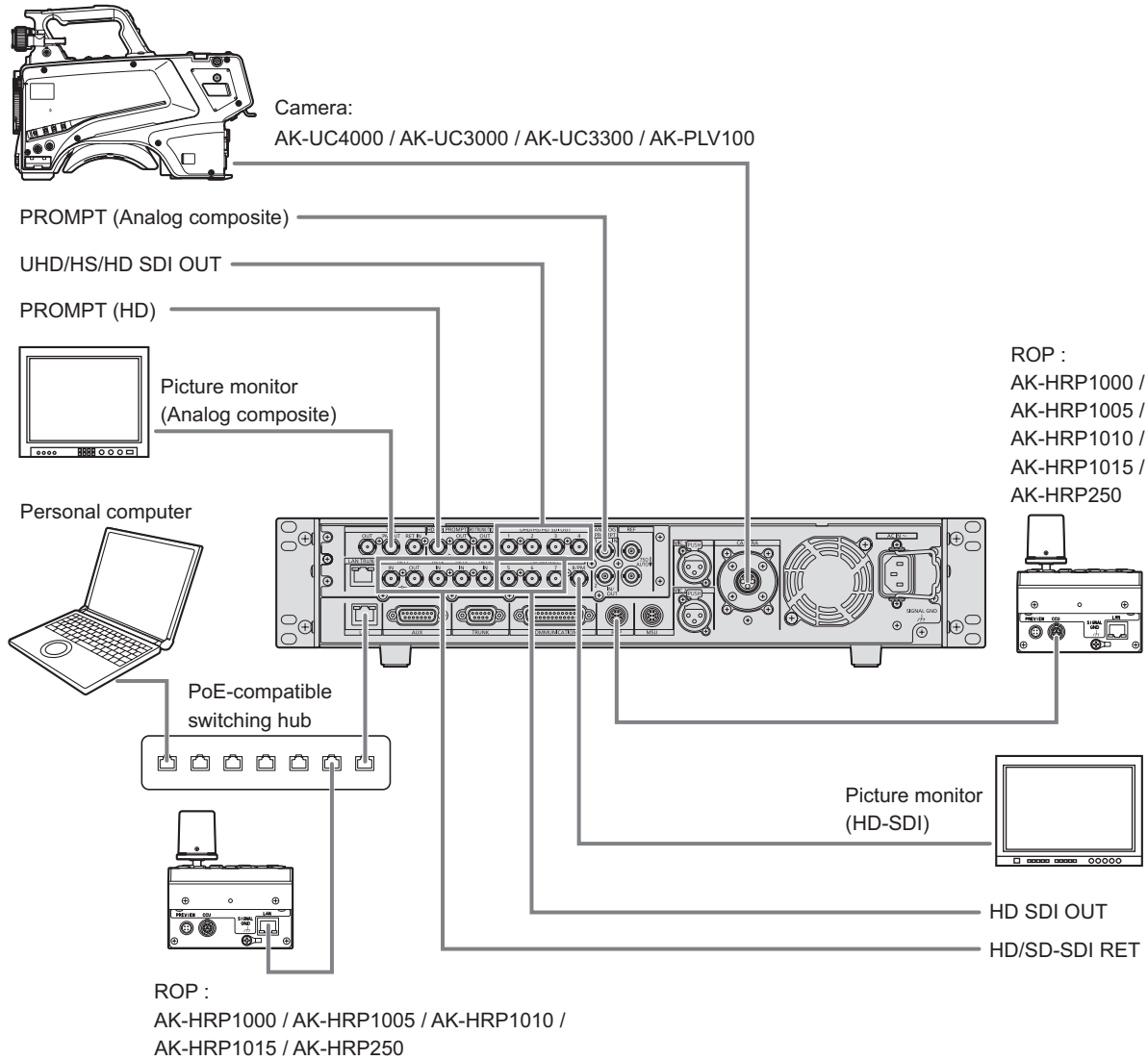

- Before proceeding with the connections, check that the power of the unit and camera is OFF.
- Use the optical fiber multi cable to connect the unit and camera.  
Connect only the AK-UC4000 / AK-UC3000 / AK-UC3300 / AK-PLV100 camera: Do not connect any other model.
- Use a dedicated cable to connect the unit to the ROP.
- When the unit's [POWER] switch is set to ON and then the camera's power is set to ON, the camera can be controlled using the ROP.
- The camera statuses are shown on the picture monitor.
  - ➔ "Picture monitor displays" (see page 27)
 When you configure the unit's settings by menu operations, the menu screens are displayed on the picture monitor.
  - ➔ "Menu operations" (see page 40)
- Before disconnecting the cables from the camera and ROP, turn off the camera's power and then turn off the unit's power.
- When connecting the unit to the ROP using IP connection via a switching hub, use a switching hub that provides PoE support.
- When operating multiple ROPs at the same time with the unit connected using IP connection via a switching hub, the ROP operated last will be given priority.

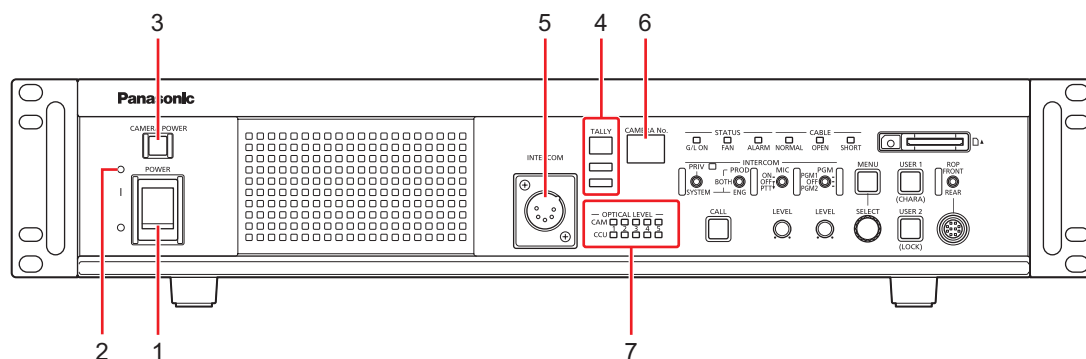

# Parts and their functions

## Front panel 1

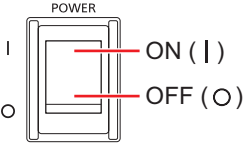

1	<b>[POWER] switch</b>	<p>This is the unit's power switch. Move it to the ON position to turn on the power.</p> 
2	<b>[POWER] lamp</b>	This lights when [POWER] switch is set to ON and power is supplied to the unit.
3	<b>[CAMERA POWER] button</b>	<p>When you press the [CAMERA POWER] button, the unit begins supplying power to the camera. The color in which the button lights varies depending on the status of the camera.</p> <p><b>Status displays</b></p> <p><b>When the [CABLE CONNECTION] menu item is set to [HYBRID]</b></p> <p>Lit (green)      When the camera's power is ON, and communication between the camera and CCU is possible</p> <p>Lit (red)        When camera was turned OFF on the camera side during standby power supply</p> <p>Flashing (red)    When the camera can be turned ON from the unit or ROP during standby power supply</p> <p>Off                When power is not supplied to the camera (e.g., [CABLE OPEN] status)</p> <p><b>When the [CABLE CONNECTION] menu item is set to [FIBER]</b></p> <p>Lit (green)      When communication between the camera and CCU is possible</p> <p>Off                When communication between the camera and CCU is not possible</p>
4	<b>[TALLY] lamps</b>	<p>The lamp remains lit while tally signals (R, G, YL) are input.</p>  <p>A. R tally lamp B. G tally lamp C. YL tally lamp</p>
5	<b>[INTERCOM] connector</b>	<p>This connector is for connecting the intercom. This connector enables calls with the intercom line of the camera. Calls can also be made with the camera when the camera's power is OFF.</p>
6	<b>[CAMERA No.] display</b>	Indicates the camera number that has been assigned to the unit.
7	<b>[OPTICAL LEVEL] indicators</b>	<p>Indicates the reception strength of optical transmission.</p> <ul style="list-style-type: none"> <li>[CAM] indicator Indicates the reception strength on the camera side.</li> <li>[CCU] indicator Indicates the reception strength on the CCU side.</li> </ul>



## Front panel 2

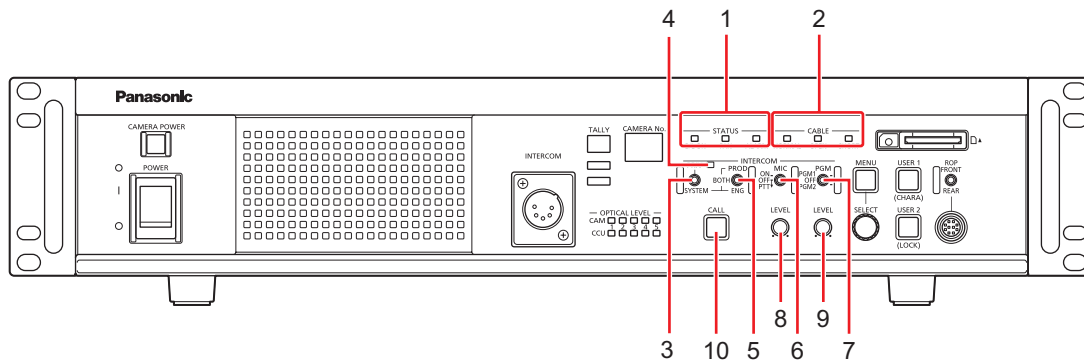

1	<b>[STATUS] indicators</b>	<p>Lights to indicate the unit status.</p> <ul style="list-style-type: none"> <li>• [G/L ON] indicator Lights when the external sync signal is synchronized. ➔ "Front panel [G/L ON] indicator specifications" (see page 183)</li> <li>• [FAN] indicator Lights when the rotation speed of the unit's cooling fan drops below the normal value.</li> <li>• [ALARM] indicator Lights when the unit malfunctions.</li> </ul>
2	<b>[CABLE] indicators</b>	<p>Lights to indicate the cable connection status.</p> <ul style="list-style-type: none"> <li>• [NORMAL] indicator This lights when the unit and camera are properly connected by the optical fiber multi cable.</li> <li>• [OPEN] indicator This lights when the unit and camera are not connected by the optical fiber multi cable.</li> <li>• [SHORT] indicator This lights when the cable connecting the unit and camera has been short-circuited.</li> </ul>
3	<b>[PRIV/SYSTEM] selector switch</b>	<p>This switch is for selecting the party to call using the intercom.</p> <p><b>Switch position</b></p> <p>PRIV: For making private calls between the unit and camera side.</p> <p>SYSTEM: For calling the intercom on the system side and camera side.</p>
4	<b>[PRIV] indicator</b>	Lights when the [PRIV/SYSTEM] selector switch is set to PRIV.
5	<b>[PROD/BOTH/ENG] selector switch</b>	This switch selects the party to which to speak via the intercom.
6	<b>[MIC] switch</b>	<p>This switch switches the intercom microphone ON/OFF.</p> <p><b>Switch position</b></p> <p>ON: The intercom microphone is turned on.</p> <p>OFF: The intercom microphone is turned off.</p> <p>PTT: The intercom microphone is on only while the switch is held down.</p>
7	<b>[PGM] switch</b>	<p>This switch mixes audio for the intercom.</p> <p><b>Switch position</b></p> <p>PGM1: The sound of PGM1 is mixed with the intercom sound.</p> <p>OFF: The sound of PGM is not mixed with the intercom sound.</p> <p>PGM2: The sound of PGM2 is mixed with the intercom sound.</p>
8	<b>[INCOM LEVEL] adjustment dial</b>	These controls are for adjusting the volume level of the sound heard through the intercom.
9	<b>[PGM LEVEL] adjustment dial</b>	This dial adjusts the volume level of the intercom's program audio mix.
10	<b>[CALL] button</b>	This button calls the camera and the ROP. During calling, it lights red.

## Front panel 3

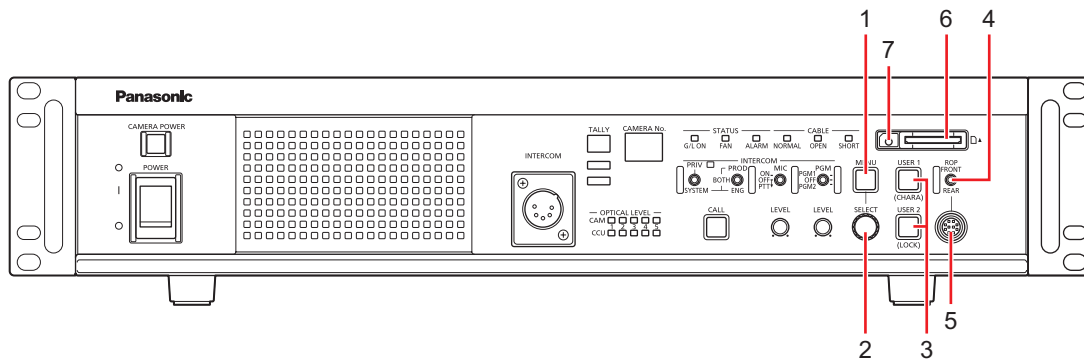

1	<b>[MENU] button</b>	When you hold down the [MENU] button, the menu screen is displayed on the picture monitor and the [MENU] button lights. If you hold down the [MENU] button while the menu is displayed, the menu closes and the [MENU] button turns off. ➔ "Menu operations" (see page 40)
2	<b>[SELECT] dial</b>	This jog dial is for menu screen operations. When the [SELECT] dial is turned clockwise, the cursor moves down; conversely, when it is turned counterclockwise, the cursor moves up. Press the [SELECT] dial to select the menu items. ➔ "Menu operations" (see page 40)
3	<b>[USER1] and [USER2] buttons</b>	These buttons are used for assigning functions. Function assignments are selected using [SETUP] in the CCU menu. The following functions are pre-assigned at the factory. [USER1] button: CHARA [USER2] button: LOCK ➔ "SETUP" (see page 93)
4	<b>[ROP FRONT/REAR] selector switch</b>	This switch switches between the [ROP] connectors on the front and rear panels. This is enabled when [MAINTENANCE] > [SETUP] > [ROP SW] is set to [SWITCH SELECT] in the CCU menu. ➔ "ROP SW" (see page 94)
5	<b>[ROP] connector (front)</b>	This connector is for connecting a ROP (sold separately).
6	<b>Memory card slot</b>	Insert a memory card (sold separately). A memory card can be used to set this unit. ➔ "SD CARD" (see page 117)
7	<b>Memory card access lamp</b>	This is lit while the memory card is being accessed.

## Rear panel 1

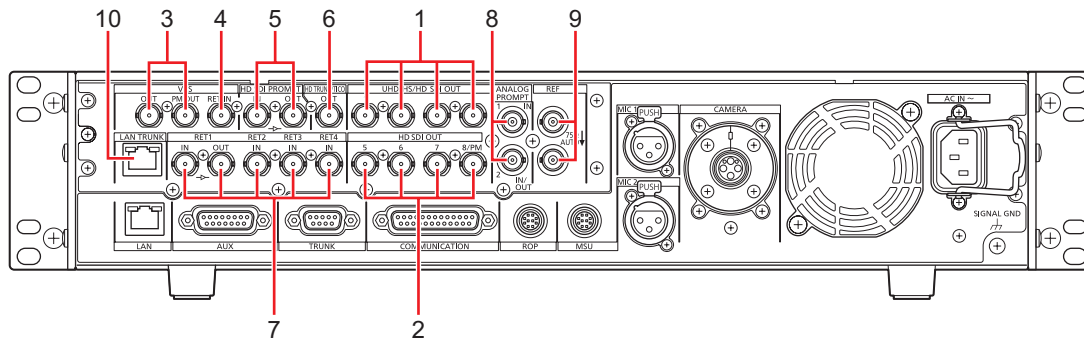

1	<b>[UHD/HS/HD SDI OUT] connectors [1] to [4]</b>	<p>UHD (connects to the AK-UC4000 / AK-UC3000 / AK-UC3300 / AK-PLV100), HS and 3G-HD, HD video signal output connectors (BNC). Signals output can be selected from the CCU menu.</p> <ul style="list-style-type: none"> <li>➔ "OUT FORMAT(UHD)" (see page 55)</li> <li>➔ "OUT FORMAT(HD)" (see page 58)</li> <li>➔ "OUT FORMAT(UHD_HDR)" (see page 60)</li> <li>➔ "OUT FORMAT(HD_HDR)" (see page 64)</li> </ul>
2	<b>[HD SDI OUT] connectors [5] to [7] and [8/PM]</b>	<p>These connectors (BNC) are for outputting SDI signals in HDTV format. The 3G-HD/HD output mode can be selected by setting the CCU menu. SDI output from the [8/PM] connector can be switched to main line image output or picture monitor output via the CCU menu configurations or ROP control.</p> <ul style="list-style-type: none"> <li>➔ "OUT FORMAT(UHD)" (see page 55)</li> <li>➔ "OUT FORMAT(HD)" (see page 58)</li> <li>➔ "OUT FORMAT(UHD_HDR)" (see page 60)</li> <li>➔ "OUT FORMAT(HD_HDR)" (see page 64)</li> </ul>
3	<b>[VBS OUT] and [VBS PM OUT] connectors</b>	<p>This connector (BNC) is for outputting analog composite signals in SDTV format. The output from [VBS PM OUT] connector can be switched between output for this unit and output for the picture monitor via the CCU menu configurations.</p> <ul style="list-style-type: none"> <li>➔ "SETTING(1/2)" (see page 67)</li> </ul> <p>This unit's analog composite signal is for use with a monitor. Frame sequence locking is not applied to the BB (black burst) synchronization signal.</p>
4	<b>[VBS RET IN] connector</b>	<p>This connector (BNC) is for inputting analog composite signals for return images in SDTV format.</p>
5	<b>[HD SDI PROMPT IN] and [HD SDI PROMPT OUT] connectors</b>	<p>These connectors (BNC) are for inputting HD-SDI prompter signals. An active through signal is output from the [HD SDI PROMPT OUT] connector.</p>
6	<b>[HD TRUNK/TICO OUT] connector</b>	<p>This connector outputs the HD SDI TRUNK signal input or TICO to the camera.</p>
7	<b>[RET1 IN] to [RET4 IN] and [RET1 OUT] connectors</b>	<p>These connectors (BNC) are for inputting SDI signals for return images in HDTV and SDTV formats. 3G, HD-SDI, and SD-SDI signals are detected automatically. The signal input to [RET1 IN] connector is output from the [RET1 OUT] connector as an active through signal.</p>
8	<b>[ANALOG PROMPT1 IN] and [ANALOG PROMPT2 IN/OUT] connectors</b>	<p>This connector (BNC) is for inputting SD analog composite signals for the prompter. It is not terminated when the unit is turned OFF. You can switch between "output connector for the signal input to IN" or "input connector for ANALOG PROMPT2" for the [ANALOG PROMPT2 IN/OUT] connector via menu configurations. However, the signal is not output when the unit is turned OFF.</p>

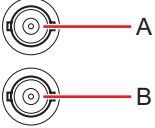
9	<b>[REF] connectors</b>	<p>These connectors (BNC) are for inputting reference signals. Black burst (BB) signals and tri-level sync signals can be input, and the type of signals input is recognized automatically.*1</p> <p>When no cable is connected to the loop-through output connector (B), the connector is automatically terminated at 75 Ω.</p> <p>Connecting a cable to this connector releases 75 Ω termination.</p> <p>When a cable is connected to the loop-through output connector (B), be sure to connect the other end of the cable to a connector.</p> <p>REF</p>  <p>A. Reference signal input connector B. Loop-through output</p> <p>*1: When the [CCU MODE] is [1080/23.98psF], input 1080/23.98psF (47.95 Hz) tri-level sync signals. For details on supported sync signals for each format, see "Front panel [G/L ON] indicator specifications." ➔ "Front panel [G/L ON] indicator specifications" (see page 183)</p>
10	<b>[LAN TRUNK] connector</b>	LAN communication is carried using optical transmission between the camera and CCU.

## Rear panel 2

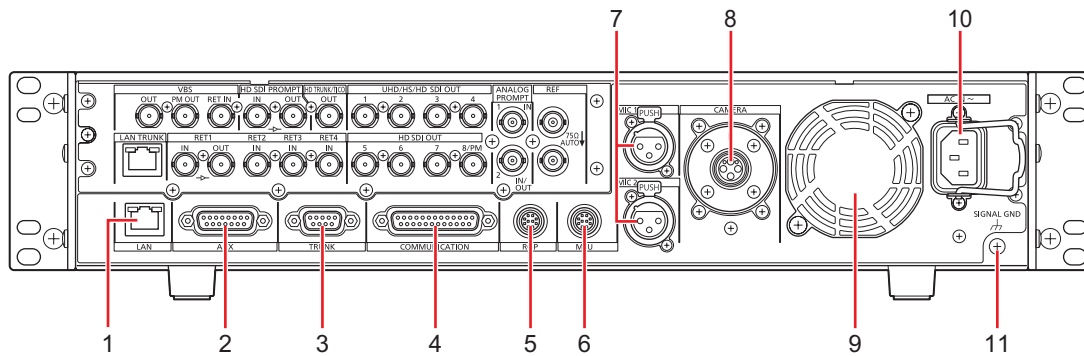

1	<b>[LAN] connector</b>	It is the LAN connector (RJ45) for connecting the ROP (AK-HRP1000 / AK-HRP1005 / AK-HRP1010 / AK-HRP1015 / AK-HRP250) with an IP connection. Use a switch hub and connect the devices with a 10BASE-T/100BASE-TX straight cable. This connector is for connecting a personal computer when configuring Web settings. ➔ "Web Screen" (see page 119)
2	<b>[AUX] connector</b>	This connector is used for controlling a waveform monitor and external systems (down-convert system, MIC gain selection, alarm output, or tally output).
3	<b>[TRUNK] connector</b>	This connector provides two systems for 2-way communication of camera trunk data (RS-422 and RS-232C).
4	<b>[COMMUNICATION] connector</b>	This connector is for connecting the intercom signals and tally signals to the external system.
5	<b>[ROP] connector</b>	This connector is for connecting a ROP (sold separately).
6	<b>[MSU] connector</b>	This connector is for connecting an MSU (sold separately).
7	<b>[MIC1] and [MIC2] connectors</b>	These connectors are for outputting the analog signals of microphones 1 and 2 of the camera. The microphone level is 0 dBm/600 Ω.
8	<b>[CAMERA] connector</b>	This connector is for connecting the optical fiber multi cable (sold separately).
9	<b>Cooling fan</b>	This is the unit's cooling fan.
10	<b>AC power socket</b>	This socket is for inputting AC power. Connect the supplied power cable, and use a 3-prong outlet and ground the unit properly.
11	<b>[SIGNAL GND] terminal</b>	Connect this to the system ground.

## Rear panel 3 (with AK-NP600 option)

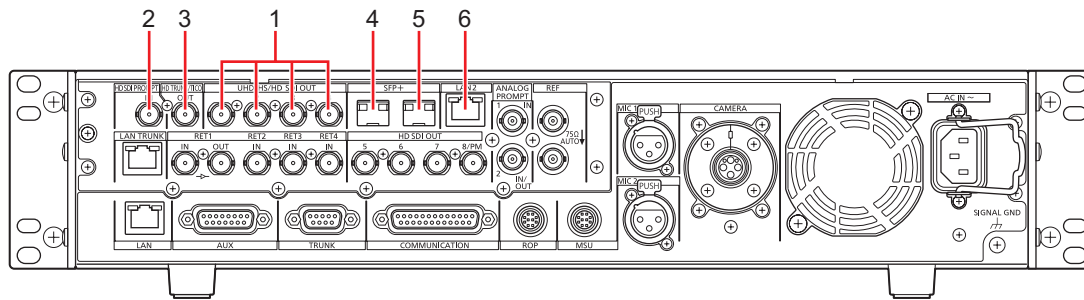

1	<b>[UHD/HS/HD SDI OUT] connectors [1] to [4]</b>	<p>UHD (connects to the AK-UC4000 / AK-UC3000 / AK-UC3300 / AK-PLV100), HS and 3G-HD, HD video signal output connectors (BNC).            Signals output can be selected from the CCU menu.</p> <ul style="list-style-type: none"> <li>➔ "OUT FORMAT(UHD)" (see page 55)</li> <li>➔ "OUT FORMAT(HD)" (see page 58)</li> <li>➔ "OUT FORMAT(UHD_HDR)" (see page 60)</li> <li>➔ "OUT FORMAT(HD_HDR)" (see page 64)</li> </ul>
2	<b>[HD SDI PROMPT IN] connector</b>	These connectors (BNC) are for inputting HD-SDI prompter signals.
3	<b>[HD TRUNK/TICO OUT] connector</b>	This connector outputs the HD SDI TRUNK signal input or TICO to the camera.
4	<b>[SFP+1] slot</b>	10GBASE-LR transceiver (SPF+) slot for MoIP input/output.
5	<b>[SFP+2] slot</b>	10GBASE-LR transceiver (SPF+) slot for MoIP input/output.
6	<b>[LAN2] connector</b>	This connector is for ROP (AK-HRP1000 / AK-HRP1005 / AK-HRP1010 / AK-HRP1015 / AK-HRP250).

# Picture monitor (PM)

## Picture monitor displays

Display the camera statuses, warnings, and other information on the picture monitor using the operation panel of the ROP.

Press the [CHARA] button (A) of the ROP to display the desired information.

- When [CHARA] is assigned to the [USER] button on the front panel of the unit (AK-UCU600), the same operation can also be carried out with the [USER] button.

The camera statuses, warnings, and other information are cleared when the [CHARA] button of the ROP is held down.

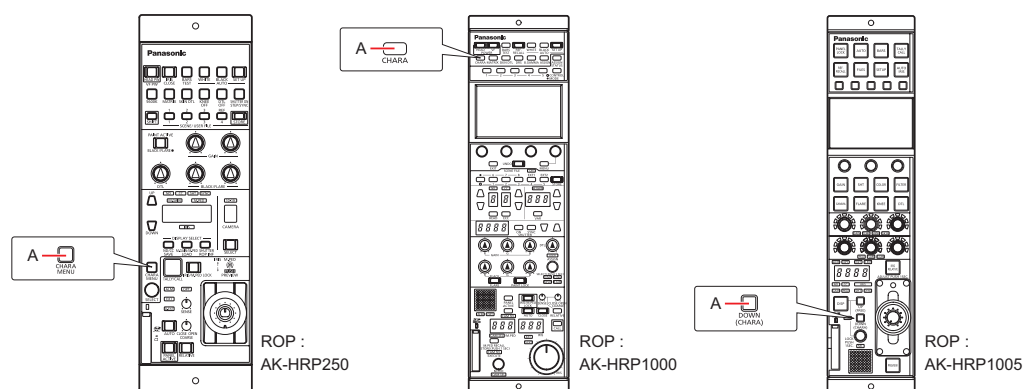

### A. [CHARA] button

## Transition of displays

When trouble is detected, warning information is automatically displayed on the picture monitor.

Even if status information or operation information is already displayed on the picture monitor when trouble is detected, priority is given to the display of the warning information.

The descending sequence of priority for the displays on the picture monitor is as follows: warning displays → auto displays → status displays → ROP menu displays → CCU menu displays → operation displays → no display.

When the warning information with the highest priority disappears, the warning information with the next highest priority appears.

Priority	Screen	ROP connected	
		Yes	No
<b>High</b> ↑ ↓ <b>Low</b>	Warning displays	Warnings are automatically displayed when trouble is detected. <ul style="list-style-type: none"> <li>• Self-recovery</li> <li>• The warning displays are cleared</li> <li>• Press the [CHARA] button of the ROP No display→(WARNING)→ IRIS →Status displays→ Status1 → Status2 → Status3 → Status4 → Status5 → Status6 → Status7 → IRIS . . .</li> <li>• Hold down the [CHARA] button of the ROP The warning displays are cleared</li> </ul>	Warnings are automatically displayed when trouble is detected. <ul style="list-style-type: none"> <li>• Self-recovery The warning displays are cleared</li> <li>• Press the [USER1] button of this unit (This is enabled when [CHARA] is assigned to the button.)               <ul style="list-style-type: none"> <li>• When the transition source screen is displayed: The display switches to the transition source screen.</li> <li>• When the transition source screen is not displayed: The warning displays are cleared</li> </ul> </li> </ul>
	Auto displays	Automatically displayed	Automatically displayed
	Status displays	<ul style="list-style-type: none"> <li>• Perform display operations using the [CHARA] button of the ROP.</li> <li>• Press the [CHARA] button of the ROP No display→(WARNING)→ IRIS →Status displays→ Status1 → Status2 → Status3 → Status4 → Status5 → Status6 → Status7 → IRIS . . .</li> <li>• Hold down the [CHARA] button of the ROP The status displays end.</li> </ul>	–
	CCU menu displays	Display by pressing the menu button on the unit. <ul style="list-style-type: none"> <li>• Operations using the [SELECT] dial on the unit</li> </ul>	Display by pressing the menu button on the unit. <ul style="list-style-type: none"> <li>• Operations using the [SELECT] dial on the unit</li> </ul>
	Operation displays	Automatically displayed	Automatically displayed
	No display	–	–



## Information display

This information is displayed on the picture monitor (PM).

### Warning displays

The warning information is displayed when trouble is detected in the unit, camera, or optical fiber multi cable.

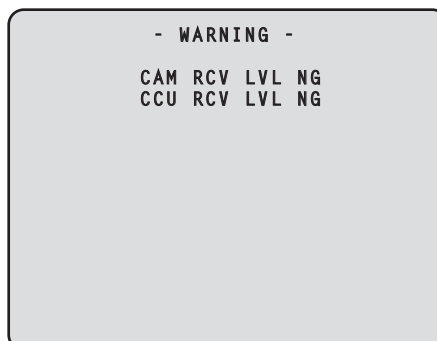

- Warning information displayed is cleared when the status returns to normal.
- To manually clear the warning information display, hold down the [CHARA] button of the ROP.

### Information displayed

Display item	Description
CAM RCV LVL NG	The level of the optical signal received by the camera is low
CCU RCV LVL NG	The level of the optical signal received by the CCU is low
CAM FAN NG	Trouble with the cooling fan of the camera
CCU FAN NG	Trouble with the cooling fan of the CCU
CAM HIGH TEMP	The temperature of the camera is abnormally high
CCU HIGH TEMP	The temperature of the CCU is abnormally high If you continue operation even with the message displayed, power supply to the camera may stop as a protective measure.
CAM OVER TEMP	Due to overheating, the camera turned OFF automatically as a protective measure
OVER LOAD	The power supply circuit load to the camera exceeded 90%
POWER CONT ERROR	Trouble with the power supply circuit to the camera
CABLE OPEN	The optical fiber multi cable is not connected
CABLE SHORT	<ul style="list-style-type: none"> <li>• The optical fiber multi cable is shorted</li> <li>• The power supply voltage to the unit dropped momentarily Power supply to the camera will stop as a protective measure. Turn the unit off immediately, and determine and resolve the problem before turning it back on.</li> <li>• The camera is malfunctioning or startup of the camera failed for reasons other than the above.</li> </ul>
FORMAT NG	The CAM mode and CCU mode do not match.
During data transfer (CAM←→ROP)	Data transfer between the camera and ROP is in progress.

## IRIS display

When the information is not displayed on the picture monitor, display it by pressing the [CHARA] button of the ROP.

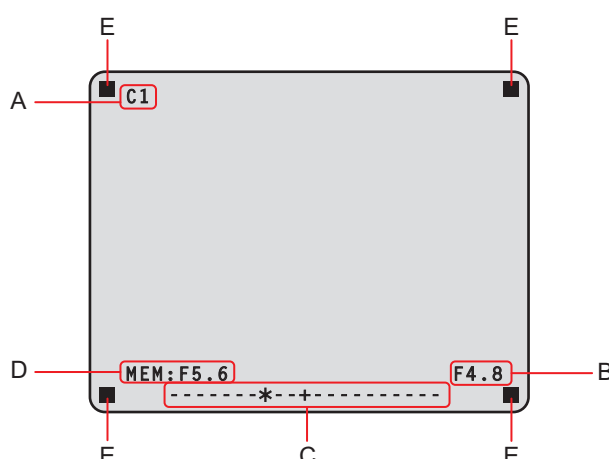

- A. Camera number
- B. IRIS F value
- C. IRIS level
- D. IRIS memory
- E. TALLY INFO

- Set each item to be displayed on the [PM VIEW SETTING] screen that can be accessed by selecting [MAINTENANCE] on the CCU menu. However, this screen will not appear if the menu's [IRIS LEVEL] setting is [OFF].
- The IRIS schedule is displayed as follows depending on the setting of [IRIS SCALE] that can be accessed by selecting [MAINTENANCE] > [SETUP].

### IRIS SCALE: FULL



### IRIS SCALE: 2STOP

- In the IRIS level display, the IRIS F value stored in IRIS memory is indicated at the center (+), and the current IRIS F value is displayed relative to the center as "\*".  
When the center value (+) and the current IRIS value (\*) overlap, the display shows "> \* <".



- When the IRIS level falls outside either end of the display range, the status is displayed as a flashing ">" or "<".



- TALLY INFO (E)
  - Display the R tally in two segments of the upper row and the R, G, or YL tally in two segments of the lower row.
  - When all R, G, and YL tally signals are ON, the upper row is red, and the left and right segments of the lower row are green and yellow, respectively.
  - When the R and G tally signals are ON, the upper row is red and the lower row is green.

## Status displays

From the IRIS display screen, press the [CHARA] button of the ROP to display the "status display screen".

However, when the "IRIS LEVEL" setting is "OFF", the screen will be displayed first if the [CHARA] button of the ROP is pressed when the information is not displayed on the picture monitor.

When the "status display screen" appears, pressing the [CHARA] button of the ROP again displays the status screen.

Pressing the [CHARA] button repeatedly switches display through the status screens in the sequence 1/7 → 2/7 → 3/7 → 4/7 → 5/7 → 6/7 → 7/7 → 1/7 ....

### Status display screen

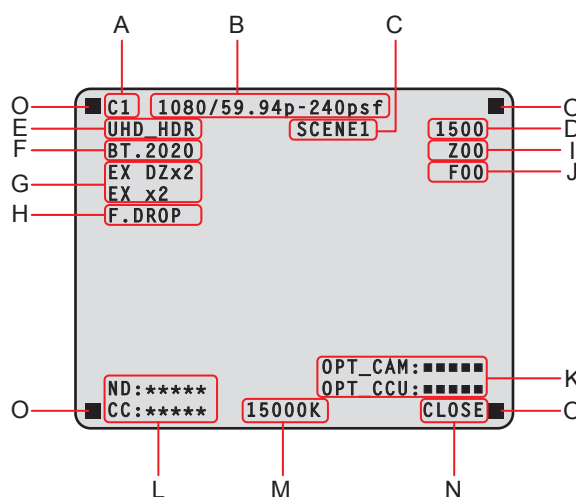

**A. Camera number**

**B. System format**

**C. Scene file number**

Not displayed when SCENE FILE is set to OFF.

**D. Shutter value**

**E. CCU format information**

**F. COLORIMETRY (Y/C conversion coefficient) information**

**G. Extender information**

**H. Lens information**

**I. Zoom position**

**J. Focus position**

**K. Optical signal reception status (camera and CCU)**

**L. ND/CC filter value**

The CC filter value is not displayed when AK-UC3300 and AK-PLV100 are connected.

**M. Color temperature**

**N. IRIS F value**

**O. TALLY INFO**

- Set each item to be displayed on the [PM VIEW SETTING] screen that can be accessed by selecting [MAINTENANCE] on the CCU menu.
- The camera format indicates the format of the signal output from the camera.
- Pressing the [CHARA] button of the ROP from the status display screen displays the "status screen".
- TALLY INFO (L)
  - Display the R tally in two segments of the upper row and the R, G, or YL tally in two segments of the lower row.
  - When all R, G, and YL tally signals are ON, the upper row is red, and the left and right segments of the lower row are green and yellow, respectively.
  - When the R and G tally signals are ON, the upper row is red and the lower row is green.

## Status displays (page 1 of 7)

1/7 -Status1-	
HLG MODE	VAR
SDR MODE	VAR
HLG B.GAMMA	ON
HLG KNEE	ON
SDR CONV GAIN	0
SDR CONV POINT	0
SDR CONV SLOPE	0

Item	Display range	Remarks
<b>HLG MODE</b>	FIX VAR	The HLG mode is displayed here.
<b>SDR MODE</b>	FIX VAR	The SDR mode is displayed here.
<b>HLG B.GAMMA</b>	OFF ON	The status of black gamma when HLG is enabled is displayed here.
<b>HLG KNEE</b>	OFF ON	The status of knee when HLG is enabled is displayed here.
<b>SDR CONV GAIN</b>	-12 -11 -10 -9 -8 -7 -6 -5 0	The gain value when HDR video is converted to SDR video is displayed here.
<b>SDR CONV POINT</b>	0 to 100	The video level to start compression for SDR video is displayed here.
<b>SDR CONV SLOPE</b>	0 to 127	The slope to compress video signals is displayed here.

## Status displays (page 2 of 7)

```

2/7  -Status2-
CAM No.          1
CAM FAN MODE     NORMAL
BLACK SHADING    OFF
WHITE SHADING    OFF
FLARE            OFF
GAMMA            OFF
BLACK GAMMA      OFF
KNEE             OFF
WHITE CLIP       OFF
DRS SW           OFF
MATRIX           OFF
SHUTTER          OFF

```

Item	Display range	Remarks
<b>CAM No.</b>	1 to 99	The camera number is displayed here.
<b>CAM FAN MODE</b>	OFF POWERFUL SILENT NORMAL	Indicates the operational mode of the camera fan.
<b>BLACK SHADING</b>	OFF ON	The status of the black shading is displayed here.
<b>WHITE SHADING</b>	OFF ON	The status of the white shading is displayed here.
<b>FLARE</b>	OFF ON	The status of the FLARE is displayed here.
<b>GAMMA</b>	OFF ON	The status of the gamma correction is displayed here.
<b>BLACK GAMMA</b>	OFF ON	The status of the black gamma is displayed here. <ul style="list-style-type: none"> <li>This function changes the amplification rate of the video signals in the low-brightness areas.</li> </ul>
<b>KNEE</b>	OFF ON	The status of the knee function is displayed here. <ul style="list-style-type: none"> <li>This function attenuates that part of the video signal that exceeds the prescribed level (knee point) to minimize saturation.</li> </ul>
<b>WHITE CLIP</b>	OFF ON	The status of the white clip function is displayed here.
<b>DRS SW</b>	OFF ON	The status of the DRS SW is displayed here.
<b>MATRIX</b>	OFF ON	The status of the matrix function is displayed here. <ul style="list-style-type: none"> <li>This function compensates the saturation and hue.</li> </ul>
<b>SHUTTER</b>	Setting values on camera	The speed of the electronic shutter is displayed here. <ul style="list-style-type: none"> <li>For the setting values, refer to the Operating Instructions for the camera.</li> </ul>

## Status displays (page 3 of 7)

```

3/7  -Status3-
GAMMA MODE          HD
M.GAIN              36dB
M.GAIN VAR          -2.9dB
UHD DETAIL          OFF
UHD SKIN TONE DETAIL OFF
HD DETAIL           OFF
HD SKIN TONE DETAIL OFF
ND FILTER           ****
CC FILTER           ****
LENS EXTENDER       1.0
AUTO IRIS           OFF
SCENE FILE          1

```

Item	Display range	Remarks
<b>GAMMA MODE</b>	HD FILMLIKE1 FILMLIKE2 FILMLIKE3 FILM REC VIDEO REC	The selected gamma type is displayed here.
<b>M.GAIN</b>	-6dB to 36dB	The gain increase value is displayed here.
<b>M.GAIN VAR</b>	-2.9dB to +2.9dB	The gain offset value is displayed here.
<b>UHD DETAIL</b>	OFF ON	The status of the UHD DETAIL is displayed here.
<b>UHD SKIN TONE DETAIL</b>	OFF ON	Indicates the status of the SKIN TONE DETAIL function. <ul style="list-style-type: none"> <li>This function minimizes the detail components applied to skin tone.</li> </ul>
<b>HD DETAIL</b>	OFF ON	The status of the HD DETAIL is displayed here.
<b>HD SKIN TONE DETAIL</b>	OFF ON	Indicates the status of the SKIN TONE DETAIL function. <ul style="list-style-type: none"> <li>This function minimizes the detail components applied to skin tone.</li> </ul>
<b>ND FILTER</b>	****	The names of the ND filters are displayed here. <ul style="list-style-type: none"> <li>Indicates the names (4 letters each) corresponding to ND filters 1 to 5.</li> <li>The names configured in the CCU screen appear.</li> <li>This will be ND filters 1 to 4 when AK-UC3300 and AK-PLV100 are connected.</li> </ul>
<b>CC FILTER</b>	****	The names of the CC filters are displayed here. <ul style="list-style-type: none"> <li>Indicates the names (5 letters each) corresponding to CC filters A to E.</li> <li>The names configured in the CCU screen appear.</li> <li>This is not displayed when AK-UC3300 and AK-PLV100 are connected.</li> </ul>
<b>LENS EXTENDER</b>	1.0 2.0	The magnification of the lens extender is displayed here.
<b>AUTO IRIS</b>	OFF ON	The status of the auto IRIS function is displayed here.
<b>SCENE FILE</b>	OFF --- 1 to 8	The selected scene file is displayed here.

## Status displays (page 4 of 7)

```

4/7  -Status4-

ASU REF          FACTORY
ASU MODE         OUT FULL

DOWNCONVERT MODE SC
UPCONVERT MODE  SC
RETURN1         RET1
RETURN2         RET2
RETURN3         RET3
RETURN4         RET4

```

Item	Display range	Remarks
<b>ASU REF</b>	FACTORY USER1 USER2 USER3 REF1 REF2 REF3	The reference file used during auto setup is displayed here. <ul style="list-style-type: none"> <li>This is not displayed when AK-PLV100 is connected.</li> </ul>
<b>ASU MODE</b>	OUT FULL OUT EASY	The auto setup mode is displayed here. <ul style="list-style-type: none"> <li>This is not displayed when AK-PLV100 is connected.</li> </ul>
<b>DOWNCONVERT MODE</b>	SC SQ LB LINK	The downconversion mode is displayed here. The displayed abbreviations represent the following. SC: SIDECUT SQ: SQUEEZE LB: LETTERBOX LINK: LINK
<b>UPCONVERT MODE</b>	SC SQ LB LINK	The upconversion mode is displayed here. The displayed abbreviations represent the following. SC: SIDECUT SQ: SQUEEZE LB: LETTERBOX LINK: LINK
<b>RETURN1</b>	RET1	The statuses of the input format allocations for SDI return signals 1 to 4 are displayed here.
<b>RETURN2</b>	RET2	
<b>RETURN3</b>	RET3	
<b>RETURN4</b>	VBS	

## Status displays (page 5 of 7)

5/7 -Status5-	
SDI OUTPUT1	UHD
SDI OUTPUT2	UHD
SDI OUTPUT3	UHD
SDI OUTPUT4	UHD
SDI OUTPUT5	HD_1080i
SDI OUTPUT6	HD_1080i
SDI OUTPUT7	HD_1080i
SDI OUTPUT8	HD_1080i
NORMAL/PM	PM
3G SDI	LEVEL-A
UHD OUTPUT FORMAT	SQUARE
HDR COLORIMETRY	BT.709

Item	Display range	Remarks	
SDI OUTPUT1	UHD	Output formats of SDI OUT1 through SDI OUT4 are displayed here.	
SDI OUTPUT2	3G		
SDI OUTPUT3	HD		
SDI OUTPUT4	UHD_HDR HD_HDR HD_SDR		
SDI OUTPUT5	UHD	Output formats of SDI OUT5 through SDI OUT7 are displayed here.	
SDI OUTPUT6	3G		
SDI OUTPUT7	HD_1080i HD_1080p HD_720p UHD_HDR 3G_HDR HD_HDR_1080i HD_HDR_1080p HD_SDR_1080i HD_HDR_720p PsF trueP OVER(3G) PsF_SDR trueP_SDR OVER(3G)_SDR PsF_HDR trueP_HDR OVER(3G)_HDR		
SDI OUTPUT8	HD_1080i HD_1080p HD_720p HD_HDR_1080i HD_HDR_1080p HD_SDR_1080i HD_HDR_720p PsF PsF_SDR PsF_HDR		Output format of SDI OUT8 is displayed here.
SDI OUTPUT8 NORMAL / PM	PM NORMAL		The signal to be output from SDI OUT8 is displayed here.
3G SDI	LEVEL-A LEVEL-B		The output format during 3G output is displayed here.
UHD OUTPUT FORMAT	INTERLEAVE SQUARE		The format (INTERLEAVE or SQUARE) of the UHD signals output from SDI OUT1 to SDI OUT4 is displayed here.
HDR COLORIMETRY	BT.709 BT.2020	The Y/C conversion coefficient is displayed here.	



## Status displays (page 6 of 7)

```

6/7  -Status6-
HD TRUNK/TICO      HD TRUNK
COMPOSITE          PM

```

Item	Display range	Remarks
HD TRUNK/TICO	HD TRUNK TICO	The signal to be output from the [HD TRUNK OUT] connector is displayed here.
COMPOSITE	PM NORMAL	The signal to be output from the [VBS PM OUT] connector is displayed here.

## Status displays (page 7 of 7)

```

7/7  -Status7-
BUTTON ASSIGN
USER1          CHARA
USER2          MENU/USER1 LOCK
ROP SW         REAR ONLY
HOURS CCU      *****H
CABLE OPEN
CABLE SHORT
CAM RECEIVE LEVEL  ■■■■■
CCU RECEIVE LEVEL  ■■■■■

VERSION        xx.xx-xxx-xx.xx

```

Item	Display range	Remarks
BUTTON ASSIGN USER1	NONE CHARA BARS CLEAN	The function assigned to the [USER1] button is displayed here.
BUTTON ASSIGN USER2	NONE CHARA MENU/USER1 LOCK BARS CLEAN	The function assigned to the [USER2] button is displayed here.
ROP SW	FRONT ONLY REAR ONLY SWITCH SELECT	This displays the operating status (front/rear) of the [ROP] connectors.
HOURS CCU	*****H	Cumulative CCU operating time is displayed here.
CABLE OPEN	(Off)	This item flashes when the optical fiber multi cable is not connected.
CABLE SHORT	(Off)	This item flashes when the optical fiber multi cable is short-circuited.
CAM RECEIVE LEVEL	■■■■■	The level of the optical signals received by the camera is displayed in 5 gradations.
CCU RECEIVE LEVEL	■■■■■	The level of the optical signals received by the unit is displayed in 5 gradations.
VERSION	---	The unit's software version is displayed here.

## Operation displays

The operation displays appear at the bottom of the screen for approx. 4 seconds when any of the following operations have been performed with the operation panel of the ROP.

- Master gain change
- Electronic shutter change
- Lens extender change
- Scene file change
- REF LOAD is changed
- FILTER is changed

The display time can be changed from [MAINTENANCE] menu > [PM OPERATION STATUS] > [STATUS DISP TIME].

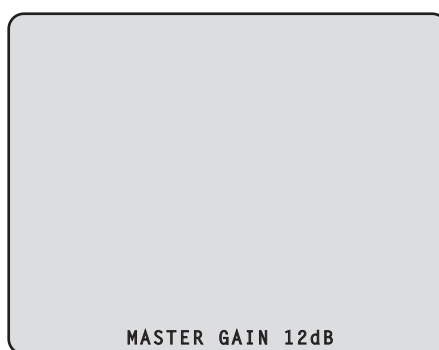

Item	Display range	Remarks
<b>MASTER GAIN</b>	Setting values on camera	The master gain value is displayed here. <ul style="list-style-type: none"> <li>• For the setting values, refer to the Operating Instructions for the camera.</li> </ul>
<b>SHUTTER</b>	Setting values on camera	The speed of the electronic shutter is displayed here. <ul style="list-style-type: none"> <li>• For the setting values, refer to the Operating Instructions for the camera.</li> </ul>
<b>LENS EXT</b>	1.0 2.0	The magnification of the lens extender is displayed here. <ul style="list-style-type: none"> <li>• When the magnification of the lens extender is set to 2x, [2.0] is displayed. Otherwise, [1.0] is displayed.</li> </ul>
<b>SCENE FILE</b>	OFF 1 to 8	This indicates the scene file name.
<b>REF LOAD</b>	FACTORY USER1 to USER3 REF1 to 3	This indicates the reference file that was loaded via reference call recalling.
<b>FILTER</b>	**** (ND/CC filter name)	The names of the ND filter/CC filters are displayed here.

## Auto displays

When the following operation is performed while no menu is displayed on the picture monitor, information on the operation performed appears at the bottom of the screen.

- AWB (Auto White Balance) function
- ABB (Auto Black Balance) function
- AUTO SETUP (Auto Setup) function
- The AUTO SETUP function does not work when AK-PLV100 is connected.

When the AUTO SETUP operations are displayed, they will remain displayed until the operations are completed.

The display is cleared 4 seconds after the operations are completed.

If the operations cannot be completed, they will remain displayed until the NG (error) items of the AUTO function are released.

The display time can be changed from [MAINTENANCE] menu > [PM OPERATION STATUS] > [STATUS DISP TIME].



Item	Display description
AWB	AWB : OK
	AWB : ACTIVE
	AWB : G/B/R NG
	AWB : BREAK
ABB	ABB : OK
	ABB : ACTIVE
	ABB : G/B/R NG
	ABB : LENS OPEN
	ABB : BREAK
AUTO SETUP	AUTO SETUP : OK (Details on the operation are displayed at the bottom.)
	AUTO SETUP : NG (Details on the NG information are displayed at the bottom.)
	AUTO SETUP : BREAK

- **AUTO SETUP operation details**

Display description
B.SHD OPERATION
W.SHD OPERATION
GAMMA OPERATION
FLARE OPERATION
AWB OPERATION
ABB OPERATION
NOT RUNNING ILLEGAL MODE

# CCU menu

## Menu operations

While viewing the menu screen of the picture monitor, operate the [MENU] button and [SELECT] dial on the front panel.

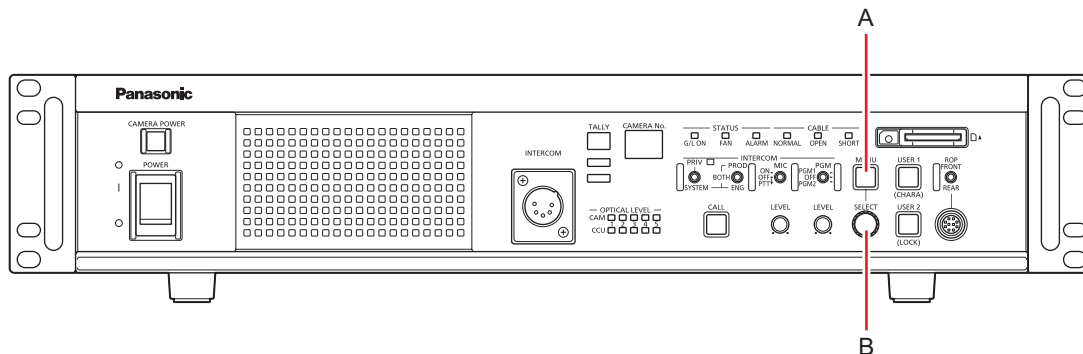

- A. [MENU] button
- B. [SELECT] dial

---

## Displaying and hiding the menus

---

Menus are displayed or hidden by the following procedure.

**1. Press the [MENU] button.**

The [MENU] button lights and the menu (CCU MENU) is displayed.

If you press the [MENU] button while the menu is displayed, the menu closes and the [MENU] button turns off.

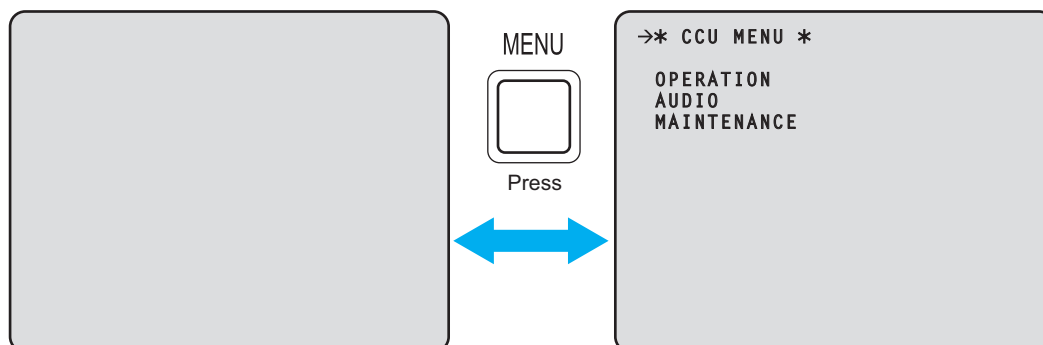

## Basic menu operations

Menu items are selected and set by the following procedure.

1. Turn the [SELECT] dial while in the [CCU MENU], select [OPERATION] or [MAINTENANCE], and then press the [SELECT] dial.

A list of menu items included in the selected item ([OPERATION] or [MAINTENANCE]) is displayed.

- When the [SELECT] dial is turned clockwise, the cursor moves down; conversely, when it is turned counterclockwise, the cursor moves up.

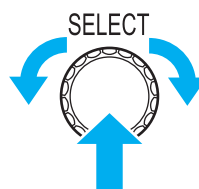
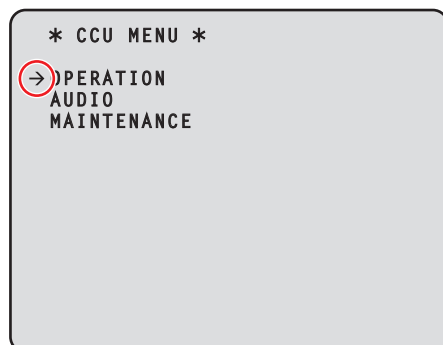

2. Turn the [SELECT] dial to move the cursor to the menu item you want to set, and then press the [SELECT] dial.

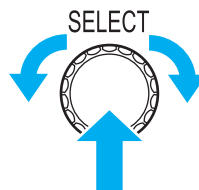
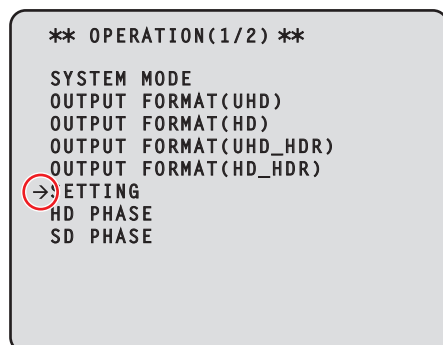

The setting screen one level below the selected menu item appears.

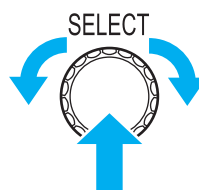
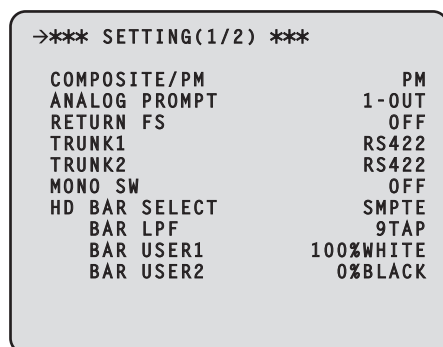

- Moving the cursor to the menu title and then pressing the [SELECT] dial redispays [CCU MENU].

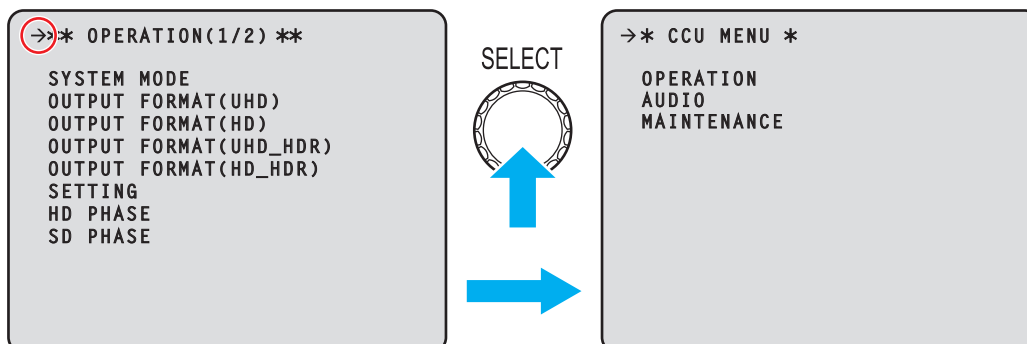

3. Turn the [SELECT] dial to move the cursor to the menu item you want to set, and then press the [SELECT] dial.

The setting value of the selected menu item starts flashing and you can change it.

```

*** SETTING(1/2) ***
-> COMPOSITE/PM          PM
ANALOG PROMPT          1-OUT
RETURN FS              OFF
TRUNK1                RS422
TRUNK2                RS422
MONO SW              OFF
HD BAR SELECT        SMPTE
BAR LPF              9TAP
BAR USER1          100%WHITE
BAR USER2           0%BLACK

```

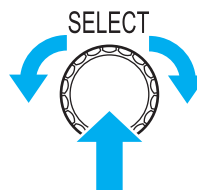

4. Turn the [SELECT] dial to change the value, and then press the [SELECT] dial.

Turning the [SELECT] dial changes the setting value and pressing the [SELECT] dial confirms the setting value.

```

*** SETTING(1/2) ***
-> COMPOSITE/PM          NORMAL
ANALOG PROMPT          1-OUT
RETURN FS              OFF
TRUNK1                RS422
TRUNK2                RS422
MONO SW              OFF
HD BAR SELECT        SMPTE
BAR LPF              9TAP
BAR USER1          100%WHITE
BAR USER2           0%BLACK

```

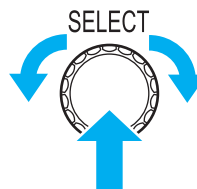

When the setting value is confirmed and the flashing stops, you can move the cursor.

With some menu items, setting changes become effective while the setting value is in the flashing state; with others, changes become effective when the [SELECT] dial is pressed to confirm the setting value.

## Operation with menu items that have multiple setting items on one line

1. Turn the [SELECT] dial to move the cursor to the menu item you want to set, and then press the [SELECT] dial.

The cursor becomes "↓" and you can use the [SELECT] dial to move the cursor to a setting item in the selected menu item.

*** BAR ID ***		
BAR ID SWITCH		OFF
BRIGHTNESS		100%
ID1 POSITION	↓	V:00 H:00
ID1		0000
ID2 POSITION	V:00	H:00
ID2		2222
OFFSET	V:000	H:000

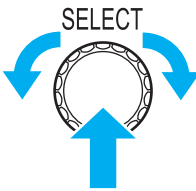

2. Turn the [SELECT] dial to move the cursor to the item you want to set, and then press the [SELECT] dial.

The setting value of the selected item starts flashing and you can change it.

*** BAR ID ***		
BAR ID SWITCH		OFF
BRIGHTNESS		100%
ID1 POSITION	V:00 ↓	H:00
ID1		0000
ID2 POSITION	V:00	H:00
ID2		2222
OFFSET	V:000	H:000

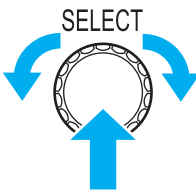

3. Turn the [SELECT] dial to change the value, and then press the [SELECT] dial.

Turning the [SELECT] dial changes the setting value and pressing the [SELECT] dial confirms the setting value.

*** BAR ID ***		
BAR ID SWITCH		OFF
BRIGHTNESS		100%
ID1 POSITION	V:00 ↓	H:05
ID1		0000
ID2 POSITION	V:00	H:00
ID2		2222
OFFSET	V:000	H:000

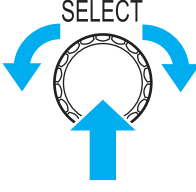

When the setting value is confirmed and the flashing stops, you can move the cursor.

If you press the [SELECT] dial while the cursor is on the left of a menu item, the cursor becomes "→" and you can select the menu item.

*** BAR ID ***		
BAR ID SWITCH		OFF
BRIGHTNESS		100%
→ ID1 POSITION	V:00	H:05
ID1		0000
ID2 POSITION	V:00	H:00
ID2		2222
OFFSET	V:000	H:000





## Text input

1. Turn the [SELECT] dial to move the cursor to the menu item where text is to be input, and then press the [SELECT] dial.

The cursor display changes as indicated by "↓". By turning the [SELECT] dial, you can move the cursor to the next (previous) character position.

*** BAR ID ***		
BAR ID SWITCH		OFF
BRIGHTNESS		100%
ID1 POSITION	V:00	H:00
ID1		0000
ID2 POSITION	V:00	H:00
ID2		2222
OFFSET	V:000	H:000

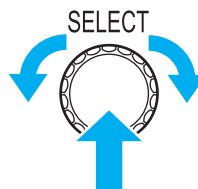

2. Turn the [SELECT] dial to move the cursor to position where a character is to be input, and then press the [SELECT] dial.

The selected character starts flashing and you can change it.

*** BAR ID ***		
BAR ID SWITCH		OFF
BRIGHTNESS		100%
ID1 POSITION	V:00	H:00
ID1		00-00
ID2 POSITION	V:00	H:00
ID2		2222
OFFSET	V:000	H:000

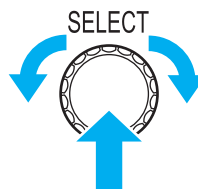

3. Turn the [SELECT] dial to change the character, and then press the [SELECT] dial.

Turning the [SELECT] dial changes characters, and pressing the [SELECT] dial confirms character changes.

*** BAR ID ***		
BAR ID SWITCH		OFF
BRIGHTNESS		100%
ID1 POSITION	V:00	H:00
ID1		00-01
ID2 POSITION	V:00	H:00
ID2		2222
OFFSET	V:000	H:000

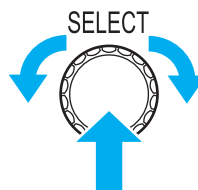

When a character has been input and the flashing stops, you can move the cursor.

If you press the [SELECT] dial while the cursor is on the left of a menu item, the cursor becomes "→" and you can select the menu item.

*** BAR ID ***		
BAR ID SWITCH		OFF
BRIGHTNESS		100%
ID1 POSITION	V:00	H:00
→ D1		0001
ID2 POSITION	V:00	H:00
ID2		2222
OFFSET	V:000	H:000



---

 **NOTE**

- Turning the [SELECT] dial clockwise while pressing it increases the speed at which the number increases (turning it counterclockwise decreases the number). Turning the dial more increases the speed even more. This operation is effective for making a large change to a value when the setting width is large (e.g., IP address or port number).

## CCU MENU

This is the first screen displayed when you press the [MENU] button.

Select one of the menus.

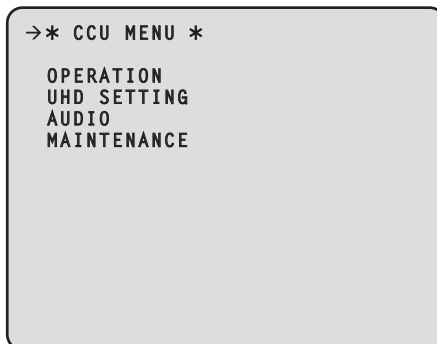

Item	Content	Details page
<b>OPERATION</b>	Open the OPERATION menu screen.	➔ "OPERATION" (see page 48)
<b>UHD SETTING</b>	Open the UHD SETTING menu screen.	➔ "UHD SETTING" (see page 78)
<b>AUDIO</b>	Open the AUDIO menu screen.	➔ "AUDIO" (see page 85)
<b>MAINTENANCE</b>	Open the MAINTENANCE menu screen.	➔ "MAINTENANCE" (see page 92)

## OPERATION

This is the selection screen for the OPERATION menu.

OUTPUT FORMAT(HS) and OUTPUT FORMAT(HS\_HDR) are not displayed when AK-PLV100 is connected.

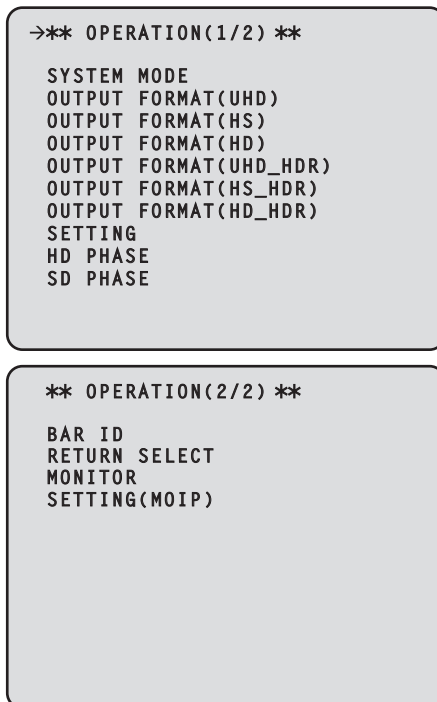

Item	Content	Details page
<b>SYSTEM MODE</b>	Display the SYSTEM MODE menu.	➔ "SYSTEM MODE" (see page 49)
<b>OUTPUT FORMAT(UHD)</b>	Display the OUT FORMAT(UHD) menu.	➔ "OUT FORMAT(UHD)" (see page 55)
<b>OUTPUT FORMAT (HS)</b>	Display the OUT FORMAT(HS) menu.	➔ "OUT FORMAT(HS)" (see page 57)
<b>OUTPUT FORMAT(HD)</b>	Display the OUT FORMAT(HD) menu.	➔ "OUT FORMAT(HD)" (see page 58)
<b>OUTPUT FORMAT(UHD_HDR)</b>	Display the OUT FORMAT(UHD_HDR) menu.	➔ "OUT FORMAT(UHD_HDR)" (see page 60)
<b>OUTPUT FORMAT (HS_HDR)</b>	Display the OUT FORMAT(HS_HDR) menu.	➔ "OUT FORMAT(HS_HDR)" (see page 62)
<b>OUTPUT FORMAT(HD_HDR)</b>	Display the OUT FORMAT(HD_HDR) menu.	➔ "OUT FORMAT(HD_HDR)" (see page 64)
<b>SETTING</b>	Display the SETTING menu.	➔ "SETTING(1/2)" (see page 67)
<b>HD PHASE</b>	Display the HD PHASE menu.	➔ "HD PHASE" (see page 69)
<b>SD PHASE</b>	Display the SD PHASE menu.	➔ "SD PHASE" (see page 69)
<b>BAR ID</b>	Display the BAR ID menu.	➔ "BAR ID" (see page 74)
<b>RETURN SELECT</b>	Display the SELECT RETURN menu.	➔ "SELECT RETURN" (see page 75)
<b>MONITOR</b>	Display the MONITOR menu.	➔ "MONITOR" (see page 76)
<b>SETTING(MOIP)</b>	Display the SETTING(MOIP) menu.	➔ "SETTING(MOIP)" (see page 77)

## SYSTEM MODE

This is the selection screen for the SYSTEM MODE menu.

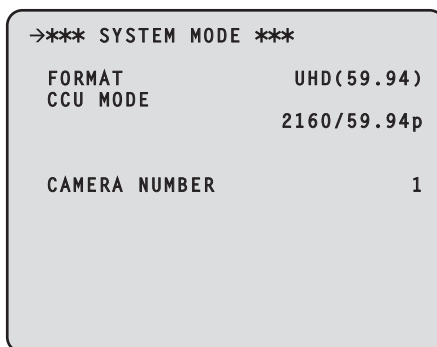

\_\_\_ indicates factory default settings.

Item	Setting value	Setting details
<b>FORMAT</b>	UHD(59.94)*1 UHD_HDR(59.94) HS(59.94) HS-HDR(59.94) HD(59.94) HD_HDR(59.94) UHD(50)*2 UHD_HDR(50) HS(50) HS-HDR(50) HD(50) HD_HDR(50)	Set the CCU format. <ul style="list-style-type: none"> <li>The unit restarts automatically when the format is changed.</li> </ul> HS(59.94)/HS_HDR(59.94)/HS(50)/HS_HDR(50) cannot be selected when AK-PLV100 is connected.
<b>CCU MODE</b>	<ul style="list-style-type: none"> <li><b>FORMAT : UHD(59.94)</b>                2160/59.94p*1                2160/29.97p                2160/23.98p                2160/29.97psF                2160/23.98psF                2160/23psF &amp; over59i</li> <li><b>FORMAT : UHD_HDR(59.94)</b>                2160/59.94p                2160/29.97p                2160/23.98p                2160/29.97psF                2160/23.98psF                2160/23psF &amp; over59i</li> <li><b>FORMAT : HS(59.94)</b>                1080/59.94p-240fps                1080/59.94p-180fps                1080/59.94p-120fps                720/59.94p-240fps                720/59.94p-180fps                720/59.94p-120fps</li> <li><b>FORMAT : HS_HDR(59.94)</b>                1080/59.94p-240fps                1080/59.94p-180fps                1080/59.94p-120fps                720/59.94p-240fps                720/59.94p-180fps                720/59.94p-120fps</li> <li><b>FORMAT : HD(59.94)</b>                1080/59.94p                1080/29.97PsF                1080/23.98PsF                1080/23.98P over59.94i                1080/23PsF &amp; over59i                720/59.94p</li> </ul>	Set the format of the CCU output signal. <p>The output signal formats that can be selected vary according to the [FORMAT] setting.</p> <p>➡ “CCU MODE and FORMAT Conditions” (see page 51)</p> <ul style="list-style-type: none"> <li>The unit restarts automatically when the format is changed.</li> </ul> The following setting values in FORMAT: HS(59.94) and FORMAT: HS_HDR(59.94) cannot be selected when AK-UC3300 is connected. <p>[1080/59.94p-240fps]            [1080/59.94p-180fps]            [720/59.94p-240fps]            [720/59.94p-180fps]</p>

Item	Setting value	Setting details
<b>CCU MODE</b>	<ul style="list-style-type: none"> <li>● <b>FORMAT : HD_HDR(59.94)</b> 1080/59.94p 1080/29.97PsF 1080/23.98PsF 1080/23.98P over59.94i 1080/23PsF &amp; over59i 720/59.94p</li> <li>● <b>FORMAT : UHD(50)</b> 2160/50p*2 2160/25p 2160/25psF</li> <li>● <b>FORMAT : UHD_HDR(50)</b> 2160/50p 2160/25p 2160/25psF</li> <li>● <b>FORMAT : HS(50)</b> 1080/50p-200fps 1080/50p-150fps 1080/50p-100fps 720/50p-200fps 720/50p-150fps 720/50p-100fps</li> <li>● <b>FORMAT : HS_HDR(50)</b> 1080/50p-200fps 1080/50p-150fps 1080/50p-100fps 720/50p-200fps 720/50p-150fps 720/50p-100fps</li> <li>● <b>FORMAT : HD(50)</b> 1080/50p 1080/25psF 720/50p</li> <li>● <b>FORMAT : HD_HDR(50)</b> 1080/50p 1080/25psF 720/50p</li> </ul>	<p>Set the format of the CCU output signal.</p> <p>The output signal formats that can be selected vary according to the [FORMAT] setting.</p> <p>➡ “CCU MODE and FORMAT Conditions” (see page 51)</p> <ul style="list-style-type: none"> <li>● The unit restarts automatically when the format is changed.</li> </ul> <p>The following setting values in FORMAT: HS(50) and FORMAT: HS_HDR(50) cannot be selected when AK-UC3300 is connected.</p> <p>[1080/50p-200fps] [1080/50p-150fps] [720/50p-200fps] [720/50p-150fps]</p>
<b>CAMERA NUMBER</b>	<u>1</u> to 99	Set the camera number to be displayed on the camera, CCU front panel, and the ROP.

\*1: AK-UCU600P/600PS

\*2: AK-UCU600E/600ES

## CCU MODE and FORMAT Conditions

FORMAT/ CCU MODE	SDI							ANALOG	
	OUT1	OUT2	OUT3	OUT4	OUT5	OUT6	OUT7	OUT8	COMPOSITE/ PM
<b>UHD(59.94)</b>									
2160/59.94p	UHD (12G): 2160/59.94p	no signal		3G: 1080/59.94p HD(1080i): 1080/59.94i HD(720): 720/59.94p			HD(1080i): 1080/59.94i HD(720): 720/59.94p		NORMAL/PM
	UHD: 2160/59.94p								
2160/29.97p (Native)	UHD (6G): 2160/29.97p	no signal		HD: 1080/29.97PsF					NORMAL/PM
	UHD: 2160/29.97p								
2160/23.98p (Native)	UHD (6G): 2160/23.98p	no signal		HD: 1080/23.98PsF					NORMAL/PM
	UHD: 2160/23.98p								
2160/29.97PsF	UHD: 2160/29.97PsF			HD: 1080/29.97PsF				NORMAL/PM	
2160/23.98PsF	UHD: 2160/23.98PsF			HD: 1080/23.98PsF				NORMAL/PM	
2160/23.98PsF & over 59i	UHD: 2160/23.98PsF			HD: 1080/23.98PsF	HD: 1080/23.98p over 59.94i			NORMAL/PM	
<b>UHD_HDR(59.94)</b>									
2160/59.94p	UHD_HDR (12G): 2160/59.94p	no signal		3G_HDR: 1080/59.94p 3G_SDR: 1080/59.94p HD_HDR(1080i): 1080/59.94i HD_SDR(1080i): 1080/59.94i HD_HDR(720p): 720/59.94p HD_SDR(720p): 720/59.94p			HD_HDR(1080i): 1080/59.94i HD_SDR(1080i): 1080/59.94i HD_HDR(720p): 720/59.94p HD_SDR(720p): 720/59.94p		NORMAL/PM
	UHD: 1080/59.94p								
2160/29.97p (Native)	UHD_HDR (6G): 2160/29.97p	no signal		HD_HDR: 1080/29.97PsF HD_SDR: 1080/29.97PsF					NORMAL/PM
	UHD_HDR: 2160/29.97p								
2160/23.98p (Native)	UHD_HDR (6G): 2160/23.98p	no signal		HD_HDR: 1080/23.98PsF HD_SDR: 1080/23.98PsF					NORMAL/PM
	UHD_HDR: 2160/23.98p								
2160/29.97PsF	UHD_HDR: 2160/29.97PsF			HD_HDR: 1080/29.97PsF HD_SDR: 1080/29.97PsF				NORMAL/PM	
2160/23.98PsF	UHD_HDR: 2160/23.98PsF			HD_HDR: 1080/23.98PsF HD_SDR: 1080/23.98PsF				NORMAL/PM	
2160/23PsF & over 59i	UHD_HDR: 2160/23.98PsF			HD_HDR: 1080/23.98PsF HD_SDR: 1080/23.98PsF	HD_HDR: 1080/23.98p over 59.94i HD_SDR: 1080/23.98p over 59.94i			NORMAL/PM	

FORMAT/ CCU MODE	SDI								ANALOG	
	OUT1	OUT2	OUT3	OUT4	OUT5	OUT6	OUT7	OUT8	COMPOSITE/ PM	
<b>HS(59.94)</b>										
1080/59.94p- 240fps	HS_3G: 1080/59.94p-240fps HS_HD: 1080/59.94i-240fps			3G: 1080/59.94p HD(1080i): 1080/59.94i HD(720p): 720/59.94p			HD(1080i): 1080/59.94i HD(720p): 720/59.94p		NORMAL/PM	
1080/59.94p- 180fps	HS_3G: 1080/59.94p- 180fps HS_HD: 1080/59.94i- 180fps		no signal		3G: 1080/59.94p HD(1080i): 1080/59.94i HD(720p): 720/59.94p			HD(1080i): 1080/59.94i HD(720p): 720/59.94p		NORMAL/PM
1080/59.94p- 120fps	HS_3G: 1080/59.94p- 120fps HS_HD: 1080/59.94i -120fps		no signal		3G: 1080/59.94p HD(1080i): 1080/59.94i HD(720p): 720/59.94p			HD(1080i): 1080/59.94i HD(720p): 720/59.94p		NORMAL/PM
720/59.94p- 240fps	HD: 720/59.94p-240fps			HD(720p): 720/59.94p						NORMAL/PM
720/59.94p- 180fps	HD: 720/59.94p-180fps		no signal		HD(720p): 720/59.94p				NORMAL/PM	
720/59.94p- 120fps	HD: 720/59.94p- 120fps		no signal		HD(720p): 720/59.94p				NORMAL/PM	
<b>HS_HDR(59.94)</b>										
1080/59.94p- 240fps	HS_3G_HDR: 1080/59.94p-240fps HS_HD_HDR: 1080/59.94i-240fps			3G_HDR: 1080/59.94p 3G_SDR: 1080/59.94p HD_HDR(1080i): 1080/59.94i HD_SDR(1080i): 1080/59.94i HD_HDR(720p): 720/59.94p HD_SDR(720p): 720/59.94p			HD(1080i)_HDR: 1080/59.94i HD(1080i)_SDR: 1080/59.94i HD(720p)_HDR: 720/59.94p HD(720p)_SDR: 720/59.94p		NORMAL/PM	
1080/59.94p- 180fps	HS_3G_HDR: 1080/59.94p-180fps HS_HD_HDR: 1080/59.94i-180fps		no signal		3G_HDR: 1080/59.94p 3G_SDR: 1080/59.94p HD_HDR(1080i): 1080/59.94i HD_SDR(1080i): 1080/59.94i HD_HDR(720p): 720/59.94p HD_SDR(720p): 720/59.94p			HD(1080i)_HDR: 1080/59.94i HD(1080i)_SDR: 1080/59.94i HD(720p)_HDR: 720/59.94p HD(720p)_SDR: 720/59.94p		NORMAL/PM
1080/59.94p- 120fps	HS_3G_HDR: 1080/59.94p -120fps HS_3G_HDR: 1080/59.94i -120fps		no signal		3G_HDR: 1080/59.94p 3G_SDR: 1080/59.94p HD_HDR(1080i): 1080/59.94i HD_SDR(1080i): 1080/59.94i HD_HDR(720p): 720/59.94p HD_SDR(720p): 720/59.94p			HD(1080i)_HDR: 1080/59.94i HD(1080i)_SDR: 1080/59.94i HD(720p)_HDR: 720/59.94p HD(720p)_SDR: 720/59.94p		NORMAL/PM
720/59.94p- 240fps	HD_HDR: 720/59.94p-240fps			HD_HDR(720p): 720/59.94p HD_SDR(720p): 720/59.94p						NORMAL/PM
720/59.94p- 180fps	HD_HDR: 720/59.94p-180fps		no signal		HD_HDR(720p): 720/59.94p HD_SDR(720p): 720/59.94p				NORMAL/PM	
720/59.94p- 120fps	HD_HDR: 720/59.94p- 120fps		no signal		HD_HDR(720p): 720/59.94p HD_SDR(720p): 720/59.94p				NORMAL/PM	
<b>HD(59.94)</b>										
1080/59.94p	3G: 1080/59.94p HD: 1080/59.94i						HD: 1080/59.94i		NORMAL/PM	
1080/29.97PsF	HD: 1080/29.97PsF								NORMAL/PM	
1080/23.98PsF	HD: 1080/23.98PsF								NORMAL/PM	
1080/23.98p over 59.94i	HD: 1080/23.98p over 59.94i								NORMAL/PM	
1080/23PsF & over 59i	HD: 1080/23.98PsF					HD: 1080/23.98p over 59.94i			NORMAL/PM	
720/59.94p	HD: 720/59.94p								NORMAL/PM	



FORMAT/ CCU MODE	SDI								ANALOG	
	OUT1	OUT2	OUT3	OUT4	OUT5	OUT6	OUT7	OUT8	COMPOSITE/ PM	
<b>HD_HDR(59.94)</b>										
1080/59.94p	3G_HDR: 1080/59.94p HD_HDR: 1080/59.94i HD_SDR: 1080/59.94i			3G_HDR: 1080/59.94p 3G_SDR: 1080/59.94p HD_HDR: 1080/59.94i HD_SDR: 1080/59.94i			HD_HDR: 1080/59.94i HD_SDR: 1080/59.94i		NORMAL/PM	
1080/29.97PsF	HD_HDR: 1080/29.97PsF HD_SDR: 1080/29.97PsF								NORMAL/PM	
1080/23.98PsF	HD_HDR: 1080/23.98PsF HD_SDR: 1080/23.98PsF								NORMAL/PM	
1080/23.98p over 59.94i	HD_HDR: 1080/23.98p over 59.94i HD_SDR: 1080/23.98p over 59.94i								NORMAL/PM	
1080/23PsF & over 59i	HD_HDR: 1080/23.98PsF HD_SDR: 1080/23.98PsF				HD_HDR: 1080/23.98p over 59.94i HD_SDR: 1080/23.98p over 59.94i				NORMAL/PM	
720/59.94p	HD_HDR: 720/59.94p HD_SDR: 720/59.94p								NORMAL/PM	
<b>UHD(50)</b>										
2160/50p	UHD(12G): 2160/50p	no signal		3G: 1080/50p HD(1080i): 1080/50i HD(720p): 720/50p			HD(1080i): 1080/50i HD(720p): 720/50p		NORMAL/PM	
	UHD: 2160/50p									
2160/25p (Native)	UHD(6G): 2160/25p	no signal		HD: 1080/25PsF						NORMAL/PM
	UHD: 2160/25p									
2160/25PsF	UHD: 2160/25PsF			HD: 1080/25PsF						NORMAL/PM
<b>UHD_HDR(50)</b>										
2160/50p	UHD_HDR(12G): 2160/50p	no signal		3G_HDR: 1080/50p 3G_SDR: 1080/50p HD_HDR(1080i): 1080/50i HD_SDR(1080i): 1080/50i HD_HDR(720p): 720/50p HD_SDR(720p): 720/50p			HD_HDR(1080i): 1080/50i HD_SDR(1080i): 1080/50i HD_HDR(720p): 720/50p HD_SDR(720p): 720/50p		NORMAL/PM	
	UHD_HDR: 1080/50p									
2160/25p (Native)	UHD_HDR(6G): 2160/25p	no signal		HD_HDR: 1080/25PsF HD_SDR: 1080/25PsF						NORMAL/PM
	UHD_HDR: 2160/25p									
2160/25PsF	UHD_HDR: 2160/25PsF			HD_HDR: 1080/25PsF HD_SDR: 1080/25PsF						NORMAL/PM
<b>HS(50)</b>										
1080/50p- 200fps	HS_3G: 1080/50p-200fps HS_HD: 1080/50i-200fps			3G: 1080/50p HD(1080i): 1080/50p HD(720p): 720/50p			HD(1080i): 1080/50i HD(720p): 720/50p		NORMAL/PM	
1080/50p- 150fps	HS_3G: 1080/50p-150fps HS_HD: 1080/50i-150fps		no signal		3G: 1080/50p HD(1080i): 1080/50p HD(720p): 720/50p			HD(1080i): 1080/50i HD(720p): 720/50p		NORMAL/PM
1080/50p- 100fps	HS_3G: 1080/50p -100fps HS_HD: 1080/50i -100fps	no signal		3G: 1080/50p HD(1080i): 1080/50p HD(720p): 720/50p			HD(1080i): 1080/50i HD(720p): 720/50p		NORMAL/PM	
720/50p- 200fps	HD: 720/50p-200fps			HD(720p): 720/50p						NORMAL/PM
720/50p- 150fps	HD: 720/50p-150fps		no signal		HD(720p): 720/50p				NORMAL/PM	
720/50p- 100fps	HD: 720/50p- 100fps		no signal		HD(720p): 720/50p				NORMAL/PM	

FORMAT/ CCU MODE	SDI								ANALOG	
	OUT1	OUT2	OUT3	OUT4	OUT5	OUT6	OUT7	OUT8	COMPOSITE/ PM	
<b>HS_HDR(50)</b>										
1080/50p- 200fps	HS_3G_HDR: 1080/50p-200fps HS_HD_HDR: 1080/50i-200fps			3G_HDR: 1080/50p 3G_SDR: 1080/50p HD_HDR(1080i): 1080/50i HD_SDR(1080i): 1080/50i HD_HDR(720p): 720/50p HD_SDR(720p): 720/50p			HD(1080i)_HDR: 1080/50i HD(1080i)_SDR: 1080/50i HD(720p)_HDR: 720/50p HD(720p)_SDR: 720/50p		NORMAL/PM	
1080/50p- 150fps	HS_3G_HDR: 1080/50p-150fps HS_HD_HDR: 1080/50i-150fps		no signal		3G_HDR: 1080/50p 3G_SDR: 1080/50p HD_HDR(1080i): 1080/50i HD_SDR(1080i): 1080/50i HD_HDR(720p): 720/50p HD_SDR(720p): 720/50p			HD(1080i)_HDR: 1080/50i HD(1080i)_SDR: 1080/50i HD(720p)_HDR: 720/50p HD(720p)_SDR: 720/50p		NORMAL/PM
1080/50p- 100fps	HS_3G_HDR: 1080/50p -100fps HS_HD_HDR: 1080/50i -100fps		no signal		3G_HDR: 1080/50p 3G_SDR: 1080/50p HD_HDR(1080i): 1080/50i HD_SDR(1080i): 1080/50i HD_HDR(720p): 720/50p HD_SDR(720p): 720/50p			HD(1080i)_HDR: 1080/50i HD(1080i)_SDR: 1080/50i HD(720p)_HDR: 720/50p HD(720p)_SDR: 720/50p		NORMAL/PM
720/50p- 200fps	HD_HDR: 720/50p-200fps			HD_HDR(720p): 720/50p HD_SDR(720p): 720/50p					NORMAL/PM	
720/50p- 150fps	HD_HDR: 720/50p-150fps		no signal		HD_HDR(720p): 720/50p HD_SDR(720p): 720/50p					NORMAL/PM
720/50p- 100fps	HD_HDR: 720/50p- 100fps		no signal		HD_HDR(720p): 720/50p HD_SDR(720p): 720/50p					NORMAL/PM
<b>HD(50)</b>										
1080/50p	3G: 1080/50p HD: 1080/50i						HD: 1080/50i		NORMAL/PM	
1080/25PsF	HD: 1080/25PsF								NORMAL/PM	
720/50p	HD: 720/50p								NORMAL/PM	
<b>HD_HDR(50)</b>										
1080/50p	3G_HDR: 1080/50p HD_HDR: 1080/50i HD_SDR: 1080/50i			3G_HDR: 1080/50p 3G_SDR: 1080/50p HD_HDR: 1080/50i HD_SDR: 1080/50i			HD_HDR: 1080/50i HD_SDR: 1080/50i		NORMAL/PM	
1080/25PsF	HD_HDR: 1080/25PsF HD_SDR: 1080/25PsF								NORMAL/PM	
720/50p	HD_HDR: 720/50p HD_SDR: 720/50p								NORMAL/PM	

 **NOTE**

- ANALOG output is not available with the AK-NP600 option.

## OUT FORMAT(UHD)

This is the selection screen for the OUT FORMAT (UHD) menu.

```

->*** OUT FORMAT(UHD)(1/2)***

SDI OUT1-4          UHD(12G)
SDI OUT1            UHD(12G)
SDI OUT2            UHD(12G)
SDI OUT3            no signal
SDI OUT4            no signal
SDI OUT5&6          3G
SDI OUT7            3G
SDI OUT8            HD
NORMAL/PM          PM
OUTPUT FORMAT      SQUARE
3G SDI              LEVEL-A
HD SDI FORMAT      1080i
  
```

```

*** OUT FORMAT(UHD)(2/2)***

HD TRUNK/TICO      HD_TRUNK
COLORIMETRY        BT.709
GAMUT              NORMAL
  
```

\_\_\_ indicates factory default settings.

Item	Setting value	Setting details
SDI OUT1-4 SDI OUT1	UHD UHD(12G)	Displays the format of the signals to be output from [1] to [4] of the [UHD/HS/HD SDI OUT] connectors. <ul style="list-style-type: none"> <li>The content selected in SDI OUT1-4 is displayed for the items of SDI OUT1-4. When there is no output, "no signal" will be displayed.</li> </ul> ➔ "Output selection conditions" (see page 56)
SDI OUT1-4 SDI OUT2	UHD(6G)	
SDI OUT1-4 SDI OUT3		
SDI OUT1-4 SDI OUT4		
SDI OUT5&6 SDI OUT7	3G HD PsF trueP OVER	Set the format of the signals to be output from [5] to [7] of the [HD SDI OUT] connectors. <p><b>When [CCU MODE] is [2160/29.97p], [2160/23.98p], [2160/25p], [2160/29.97PsF], [2160/23.98PsF] or [2160/25PsF]:</b> PsF/trueP/OVER(3G)</p> SDI OUT5&6 and SDI OUT7 are set to the same signal. (They cannot be set individually.) <p><b>When [CCU MODE] is other than [2160/29.97p], [2160/23.98p], [2160/25p], [2160/29.97PsF], [2160/23.98PsF], [2160/25PsF]:</b> 3G/HD</p> ➔ "Output selection conditions" (see page 56)
SDI OUT8	HD PsF	Set the format of the signals to be output from [8/PM] of the [HD SDI OUT] connector. <p><b>When [CCU MODE] is [2160/29.97p], [2160/23.98p], [2160/25p], [2160/29.97PsF], [2160/23.98PsF] or [2160/25PsF]:</b> PsF (fixed)</p> <p><b>When [CCU MODE] is other than [2160/29.97p], [2160/23.98p], [2160/25p], [2160/29.97PsF], [2160/23.98PsF], [2160/25PsF]:</b> HD (fixed)</p> ➔ "Output selection conditions" (see page 56)
SDI OUT8 NORMAL/PM	PM NORMAL	Set the signal to be output from [8/PM] of the [HD SDI OUT] connector. <p>➔ Can only be set to PM when using a MoIP board (AK-NP600).</p> <p><b>PM :</b> Output the picture monitor images.</p> <p><b>NORMAL :</b> Output the main line images.</p>

Item	Setting value	Setting details
<b>OUTPUT FORMAT</b>	INTERLEAVE SQUARE	Set the format (INTERLEAVE/SQUARE) of the UHD signals to be output from [1] to [4] of the [UHD/HS/HD SDI OUT] connectors.  <b>When [CCU MODE] is [2160/29.97psF], [2160/23.98psF], [2160/25psF] or [2160/23PsF &amp; over59i]:</b> SQUARE (fixed)
<b>3G SDI</b>	LEVEL-A LEVEL-B	Set the output format for 3G output.
<b>HD SDI FORMAT</b>	1080i 1080p 720p	Set the format for when the output format for SDI 5 to 8 is HD.  <b>When [CCU MODE] is [2160/59.94p]:</b> 1080i/720p  <b>When [CCU MODE] is [2160/29.97p], [2160/23.98p], [2160/29.97psF], [2160/23.98psF] or [2160/23PsF &amp; over59i]:</b> 1080p (fixed)  <b>When [CCU MODE] is [2160/50p]:</b> 1080i  <b>When [CCU MODE] is [2160/25p] or [2160/25psF]:</b> 1080p (fixed)
<b>HD TRUNK/TICO</b>	HD_TRUNK TICO	Set the signal to be output from the [HD TRUNK/TICO OUT] connector.  <b>HD_TRUNK:</b> Outputs the signals compatible with HD_TRUNK.  <b>TICO:</b> Outputs the signals compatible with TICO.
<b>COLORIMETRY</b>	BT.709 BT.2020	Change the Y/C conversion coefficient.
<b>GAMUT</b>	NORMAL WIDE_G WIDE_G2	Change the color gamut.  <ul style="list-style-type: none"> <li>Applies only to the signals output from the [SDI OUT 1] to [SDI OUT 4] connectors.</li> <li>This will be NORMAL/WIDE_G when AK-UC3000 is connected.</li> <li>This will be NORMAL/WIDE_G2 when AK-PLV100 is connected.</li> </ul>

### Output selection conditions

FORMAT/ CCU MODE	SDI								ANALOG COMPOSITE/ PM
	OUT1	OUT2	OUT3	OUT4	OUT5	OUT6	OUT7	OUT8	
<b>UHD(59.94)</b>									
2160/59.94p	UHD(12G), UHD			3G, HD(1080i)			HD(1080i)		NORMAL/PM
2160/29.97p	UHD(6G), UHD			PsF, TrueP, OVER(3G)			PsF		NORMAL/PM
2160/23.98p	UHD(6G), UHD			PsF, TrueP, OVER(3G)			PsF		NORMAL/PM
2160/29.97psF	UHD			PsF, TrueP, OVER(3G)			PsF		NORMAL/PM
2160/23.98psF	UHD			PsF, TrueP, OVER(3G)			PsF		NORMAL/PM
2160/23psF & over59i	UHD			HD			HD		NORMAL/PM
<b>UHD(50)</b>									
2160/50p	UHD(12G), UHD			3G, HD(1080i)			HD(1080i)		NORMAL/PM
2160/25p	UHD(6G), UHD			PsF, TrueP, OVER(3G)			PsF		NORMAL/PM
2160/25psF	UHD			PsF, TrueP, OVER(3G)			PsF		NORMAL/PM

## OUT FORMAT(HS)

This is the selection screen for the OUT FORMAT (HS) menu.

- This is not displayed when AK-PLV100 is connected.

```

->*** OUT FORMAT(HS) ***

SDI OUT1          HS_3G
SDI OUT2          HS_3G
SDI OUT3          HS_3G
SDI OUT4          HS_3G
SDI OUT5&6       HD
SDI OUT7          HD
SDI OUT8          HD
NORMAL/PM        PM
3G SDI           LEVEL-A
HD SDI FORMAT    1080i
  
```

\_\_\_ indicates factory default settings.

Item	Setting value	Setting details
SDI OUT1-4	HS_3G HS_HD	Displays the format of the signals to be output from [1] to [4] of the [UHD/HS/HD SDI OUT] connectors.
SDI OUT5&6	3G HD	Set the format of the signals to be output from [5] to [6] of the [HD SDI OUT] connectors.
SDI OUT7	3G HD	Set the format of the signals to be output from [7] of the [HD SDI OUT] connector.
SDI OUT8	HD	Displays the format of the signals to be output from [8/PM] of the [HD SDI OUT] connectors. (fixed)
SDI OUT8 NORMAL/PM	PM NORMAL	Set the signal to be output from [8/PM] of the [HD SDI OUT] connector. ➔ Can only be set to PM when using a MoIP board (AK-NP600). <b>PM :</b> Output the picture monitor images. <b>NORMAL :</b> Output the main line images.
3G SDI	LEVEL-A LEVEL-B	Set the output format for 3G output.
HD SDI FORMAT	1080i 720P	Set the format for HD output.

### Output selection conditions

FORMAT/ CCU MODE	SDI								ANALOG
	OUT1	OUT2	OUT3	OUT4	OUT5	OUT6	OUT7	OUT8	COMPOSITE/ PM
<b>UHD(59.94)</b>									
1080/59.94p-240fps	HS_3G, HS_HD			3G, HD			HD		NORMAL/PM
1080/59.94p-180fps	HS_3G, HS_HD			no signal	3G, HD			HD	NORMAL/PM
1080/59.94p-120fps	HS_3G, HS_HD		no signal		3G, HD			HD	NORMAL/PM
720/59.94p-240fps	HD			HD			HD		NORMAL/PM
720/59.94p-180fps	HD			no signal	HD			HD	NORMAL/PM
720/59.94p-120fps	HD		no signal		HD			HD	NORMAL/PM
<b>HS(50)</b>									
1080/50p-200fps	HS_3G, HS_HD			3G, HD			HD		NORMAL/PM
1080/50p-150fps	HS_3G, HS_HD			no signal	3G, HD			HD	NORMAL/PM
1080/50p-100fps	HS_3G, HS_HD		no signal		3G, HD			HD	NORMAL/PM
720/50p-200fps	HD			HD			HD		NORMAL/PM
720/50p-150fps	HD			no signal	HD			HD	NORMAL/PM
720/50p-100fps	HD		no signal		HD			HD	NORMAL/PM

## OUT FORMAT(HD)

This is the selection screen for the OUT FORMAT (HD) menu.

->*** OUT FORMAT(HD) ***	
SDI OUT1-4	3G
SDI OUT1	3G
SDI OUT2	3G
SDI OUT3	3G
SDI OUT4	3G
SFP+ OUT	3G
SDI OUT5&6	3G
SDI OUT7	3G
SDI OUT8	HD
NORMAL/PM	NORMAL
3G SDI	LEVEL-A

\_\_\_ indicates factory default settings.

Item	Setting value	Setting details
SDI OUT1-4 SDI OUT1	3G HD	Set the format of the signals to be output from [1] to [4] of the [UHD/HS/HD SDI OUT] connectors. ➔ "Output selection conditions" (see page 59)  The settings of [SDI OUT5] and [SDI OUT6] are linked and change together.  [SFP+ OUT] is displayed when a MoIP board (AK-NP600) is connected.  [SFP+ OUT] follows the [SDI OUT1-4] setting in the same way as [SDI OUT 1/2/3/4].  Output from SFP+ is enabled only when CCU MODE is set to [1080/59.94P], [720/59.94p], [1080/50p], or [720/50p].
SDI OUT1-4 SDI OUT2		
SDI OUT1-4 SDI OUT3		
SDI OUT1-4 SDI OUT4		
SDI OUT1-4 SFP+ OUT		
SDI OUT5&6 SDI OUT7	3G HD PsF trueP OVER(3G)	Set the format of the signals to be output from [5] to [7] of the [HD SDI OUT] connectors.  The settings of [SDI OUT5] and [SDI OUT6] are linked and change together.  <b>When [CCU MODE] is [1080/29.97PsF], [1080/23.98PsF] or [1080/25PsF]:</b> PsF/trueP/OVER(3G)  SDI OUT5&6 and SDI OUT7 are set to the same signal. (They cannot be set individually.)  <b>When [CCU MODE] is other than [1080/29.97PsF], [1080/23.98PsF], [1080/25PsF]:</b> 3G/HD  ➔ "Output selection conditions" (see page 59)
SDI OUT8	HD PsF	
SDI OUT8 NORMAL/PM	PM NORMAL	Set the signal to be output from [8/PM] of the [HD SDI OUT] connector.  ➔ Can only be set to PM when using a MoIP board (AK-NP600).  <b>PM :</b> Output the picture monitor images.  <b>NORMAL :</b> Output the main line images.
3G SDI	LEVEL-A LEVEL-B	Set the output format for 3G output.

## Output selection conditions

FORMAT/ CCU MODE	SDI								ANALOG	
	OUT1	OUT2	OUT3	OUT4	OUT5	OUT6	OUT7	OUT8	COMPOSITE/ PM	
<b>HD(59.94)</b>										
1080/59.94p	3G/HD							HD		NORMAL/PM
1080/29.97PsF	HD			PsF, TrueP, OVER(3G)				PsF	NORMAL/PM	
1080/23.98PsF	HD			PsF, TrueP, OVER(3G)				PsF	NORMAL/PM	
1080/23.98p over 59.94i	HD							HD	NORMAL/PM	
1080/23PsF & over59i	HD							HD	NORMAL/PM	
720/59.94p	HD							HD	NORMAL/PM	
<b>HD(50)</b>										
1080/50p	3G/HD							HD		NORMAL/PM
1080/25psF	HD			PsF, TrueP, OVER(3G)				PsF	NORMAL/PM	
720/50p	HD							HD	NORMAL/PM	

## With AK-NP600 option

FORMAT/ CCU MODE	SDI								SFP+	
	OUT1	OUT2	OUT3	OUT4	OUT5	OUT6	OUT7	OUT8	1 / 2	
<b>HD(59.94)</b>										
1080/59.94p	3G/HD							HD		3G/HD
1080/23PsF & over59i	HD							HD		no signal
1080/23.98p over 59.94i	HD							HD		no signal
1080/29.97PsF	HD			PsF, TrueP, OVER(3G)				PsF		no signal
1080/23.98PsF	HD			PsF, TrueP, OVER(3G)				PsF		no signal
720/59.94p	HD							HD		HD
<b>HD(50)</b>										
1080/50p	3G/HD							HD		3G/HD PM
1080/25PsF	HD			PsF, TrueP, OVER(3G)				PsF		no signal
720/50p	HD							HD		HD

## OUT FORMAT(UHD\_HDR)

This is the selection screen for the OUT FORMAT(UHD\_HDR) menu.

```

->*** OUT FORMAT(UHD_HDR)(1/2)*

SDI OUT1-4      UHD_HDR(12G)
SDI OUT1        UHD_HDR(12G)
SDI OUT2        UHD_HDR(12G)
SDI OUT3        no signal
SDI OUT4        no signal
SDI OUT5&6      HD_HDR
SDI OUT7        HD_HDR
SDI OUT8        HD_HDR
                NORMAL/PM
OUTPUT FORMAT   SQUARE
3G SDI          LEVEL-A
HD SDI FORMAT   1080i
  
```

```

*** OUT FORMAT(UHD_HDR)(2/2)*

HD TRUNK/TICO   HD_TRUNK
HDR COLORIMETRY BT.2020
GAMUT           NORMAL
  
```

\_\_\_ indicates factory default settings.

Item	Setting value	Setting details
SDI OUT1-4 SDI OUT1	UHD_HDR UHD_HDR(12G)	Displays the format of the signals to be output from [1] to [4] of the [UHD/HS/HD SDI OUT] connectors.  • The content selected in SDI OUT1-4 is displayed for the items of SDI OUT1-4. When there is no output, "no signal" will be displayed.  ➔ "Output selection conditions" (see page 61)
SDI OUT1-4 SDI OUT2	UHD_HDR(6G)	
SDI OUT1-4 SDI OUT3		
SDI OUT1-4 SDI OUT4		
SDI OUT5&6 SDI OUT7	3G_HDR HD_HDR 3G_SDR HD_SDR PsF_HDR PsF_SDR TrueP_HDR OVER(3G) PsF_SDR TrueP_SDR OVER(3G)_SDR	Set the format of the signals to be output from [5] to [7] of the [HD SDI OUT] connectors.  <b>When [CCU MODE] is set to [2160/29.97p], [2160/23.98p], [2160/25p], [2160/29.97PsF], [2160/23.98PsF] or [2160/25PsF]:</b> PsF_HDR/PsF_SDR/TrueP_HDR/TrueP_SDR/OVER(3G)_HDR/OVER(3G)_SDR  With PsF/TrueP/OVER(3G), the settings made for SDI OUT5&6 are reflected in SDI OUT7, and only switching between HDR/SDR is possible in SDI OUT7.  <b>When [CCU MODE] is other than [2160/29.97p], [2160/23.98p], [2160/25p], [2160/29.97PsF], [2160/23.98PsF], [2160/25PsF]:</b> 3G_HDR/3G_SDR/HD_HDR/HD_SDR  ➔ "Output selection conditions" (see page 61)
SDI OUT8	HD_HDR HD_SDR PsF_HDR PsF_SDR	Set the format of the signals to be output from [8/PM] of the [HD SDI OUT] connector.  <b>When [CCU MODE] is set to [2160/29.97p], [2160/23.98p], [2160/25p], [2160/29.97PsF], [2160/23.98PsF] or [2160/25PsF]:</b> PsF_HDR/PsF_SDR  <b>When [CCU MODE] is other than [2160/29.97p], [2160/23.98p], [2160/25p], [2160/29.97PsF], [2160/23.98PsF], [2160/25PsF]:</b> HD_HDR/HD_SDR  ➔ "Output selection conditions" (see page 61)
SDI OUT8 NORMAL/PM	PM NORMAL	Set the signal to be output from [8/PM] of the [HD SDI OUT] connector.  ➔ Can only be set to PM when using a MoIP board (AK-NP600).  <b>PM :</b> Output the picture monitor images.  <b>NORMAL :</b> Output the main line images.



Item	Setting value	Setting details
<b>OUTPUT FORMAT</b>	INTERLEAVE SQUARE	Set the format (INTERLEAVE/SQUARE) of the UHD signals to be output from [1] to [4] of the [UHD/HS/HD SDI OUT] connectors.  <b>When [CCU MODE] is set to [2160/29.97psF], [2160/23.98psF], [2160/25psF] or [2160/23psF &amp; over59i]:</b> SQUARE (fixed)
<b>3G SDI</b>	LEVEL-A LEVEL-B	Set the output format for 3G output.
<b>HD SDI FORMAT</b>	1080i 1080p 720p	Set the format for when the output format for SDI 5 to 8 is HD_HDR.  <b>When [CCU MODE] is [2160/59.94p]:</b> 1080i/720p  <b>When [CCU MODE] is [2160/29.97p], [2160/23.98p], [2160/29.97psF], [2160/23.98psF] or [2160/23PsF &amp; over59i]:</b> 1080p (fixed)  <b>When [CCU MODE] is [2160/50p]:</b> 1080i  <b>When [CCU MODE] is [2160/25p] or [2160/25psF]:</b> 1080p (fixed)
<b>HD TRUNK/TICO</b>	HD_TRUNK TICO	Set the signal to be output from the [HD TRUNK/TICO OUT] connector.  <b>HD_TRUNK:</b> Outputs the signals compatible with HD_TRUNK.  <b>TICO:</b> Outputs the signals compatible with TICO.
<b>HDR COLORIMETRY</b>	BT.709 BT.2020	Change the Y/C conversion coefficient.
<b>GAMUT</b>	NORMAL WIDE_G WIDE_G2	Change the color gamut.  <ul style="list-style-type: none"> <li>Applies only to the signals output from the [SDI OUT 1] to [SDI OUT 4] connectors.</li> <li>This will be NORMAL/WIDE_G when AK-UC3000 is connected.</li> <li>This will be NORMAL/WIDE_G2 when AK-PLV100 is connected.</li> </ul>

### Output selection conditions

FORMAT/ CCU MODE	SDI								ANALOG COMPOSITE/ PM
	OUT1	OUT2	OUT3	OUT4	OUT5	OUT6	OUT7	OUT8	
<b>UHD_HDR(59.94)</b>									
<b>2160/59.94p</b>	UHD_HDR(12G)	no signal		3G_HDR, 3G_SDR, HD_HDR, HD_SDR			HD_HDR, HD_SDR		NORMAL/PM
	UHD_HDR								
<b>2160/29.97p</b>	UHD_HDR(6G)	no signal		PsF_HDR, PsF_SDR, TrueP_HDR, TrueP_SDR, OVER(3G)_HDR, OVER(3G)_SDR			PsF_HDR, PsF_SDR		NORMAL/PM
	UHD_HDR								
<b>2160/23.98p</b>	UHD_HDR(6G)	no signal		PsF_HDR, PsF_SDR, TrueP_HDR, TrueP_SDR, OVER(3G)_HDR, OVER(3G)_SDR			PsF_HDR, PsF_SDR		NORMAL/PM
	UHD_HDR								
<b>2160/29.97PsF</b>	UHD_HDR			PsF_HDR, PsF_SDR, TrueP_HDR, TrueP_SDR, OVER(3G)_HDR, OVER(3G)_SDR			PsF_HDR, PsF_SDR		NORMAL/PM
<b>2160/23.98PsF</b>	UHD_HDR			PsF_HDR, PsF_SDR, TrueP_HDR, TrueP_SDR, OVER(3G)_HDR, OVER(3G)_SDR			PsF_HDR, PsF_SDR		NORMAL/PM
<b>2160/23.98PsF &amp; over 59i</b>	UHD_HDR			HD_HDR, HD_SDR					NORMAL/PM
<b>UHD_HDR(50)</b>									
<b>2160/50p</b>	UHD_HDR(12G)	no signal		3G_HDR, 3G_SDR, HD_HDR, HD_SDR			HD_HDR, HD_SDR		NORMAL/PM
	UHD_HDR								
<b>2160/25p</b>	UHD_HDR(6G)	no signal		PsF_HDR, PsF_SDR, TrueP_HDR, TrueP_SDR, OVER(3G)_HDR, OVER(3G)_SDR			PsF_HDR, PsF_SDR		NORMAL/PM
	UHD_HDR								
<b>2160/25PsF</b>	UHD_HDR			PsF_HDR, PsF_SDR, TrueP_HDR, TrueP_SDR, OVER(3G)_HDR, OVER(3G)_SDR			PsF_HDR, PsF_SDR		NORMAL/PM

## OUT FORMAT(HS\_HDR)

This is the selection screen for the OUT FORMAT(HS\_HDR) menu.

- This is not displayed when AK-PLV100 is connected.

```

->*** OUT FORMAT(HS_HDR)(1/2) ***

SDI OUT1-4      HS_3G_HDR
SDI OUT1        HS_3G_HDR
SDI OUT2        HS_3G_HDR
SDI OUT3        HS_3G_HDR
SDI OUT4        HS_3G_HDR
SDI OUT5&6      HD_SDR
SDI OUT7        HD_SDR
SDI OUT8        HD_SDR
   NORMAL/PM    PM
3G SDI          LEVEL-A
HD SDI FORMAT   1080i
  
```

```

*** OUT FORMAT(HS_HDR)(2/2) ***

HDR COLORIMETRY  BT.2020
->HDR GAMUT      WIDE_G2
  
```

\_\_\_ indicates factory default settings.

Item	Setting value	Setting details
SDI OUT1-4	HS_3G_HDR HS_HD_HDR	Displays the format of the signals to be output from [1] to [4] of the [UHD/HS/HD SDI OUT] connectors.
SDI OUT5&6	3G_HDR HD_HDR 3G_SDR HD_SDR	Set the format of the signals to be output from [5] to [6] of the [HD SDI OUT] connectors.
SDI OUT7	3G_HDR HD_HDR 3G_SDR HD_SDR	Set the format of the signals to be output from [7] of the [HD SDI OUT] connector.
SDI OUT8	HD_HDR HD_SDR	Displays the format of the signals to be output from [8/PM] of the [HD SDI OUT] connectors.
SDI OUT8 NORMAL/PM	PM NORMAL	Set the signal to be output from [8/PM] of the [HD SDI OUT] connector. ➡ Can only be set to PM when using a MoIP board (AK-NP600). <b>PM :</b> Output the picture monitor images. <b>NORMAL :</b> Output the main line images.
3G SDI	LEVEL-A LEVEL-B	Set the output format for 3G output.
HD SDI FORMAT	1080i 720P	Set the format for HD output.
HDR COLORIMETRY	BT.709 BT.2020	Switches the Y/C conversion coefficient.
HDR GAMUT	NORMAL WIDE_G WIDE_G2	Switches the color gamut. • Only signals output from the [SDI OUT 1] to [SDI OUT 4] connectors are switched. • This will be NORMAL/WIDE_G when AK-UC3000 is connected.

## Output selection conditions

FORMAT/ CCU MODE	SDI								ANALOG COMPOSITE/ PM
	OUT1	OUT2	OUT3	OUT4	OUT5	OUT6	OUT7	OUT8	
<b>HS_HDR(59.94)</b>									
1080/59.94p-240fps	HS_3G_HDR, HS_HD_HDR			3G_HDR, 3G_SDR, HD_HDR, HD_SDR			HD_HDR, HD_SDR		NORMAL/PM
1080/59.94p-180fps	HS_3G_HDR, HS_HD_HDR		no signal	3G_HDR, 3G_SDR, HD_HDR, HD_SDR			HD_HDR, HD_SDR		NORMAL/PM
1080/59.94p-120fps	HS_3G_HDR, HS_HD_HDR		no signal	3G_HDR, 3G_SDR, HD_HDR, HD_SDR			HD_HDR, HD_SDR		NORMAL/PM
720/59.94p-240fps	HD_HDR			HD_HDR, HD_SDR					NORMAL/PM
720/59.94p-180fps	HD_HDR		no signal	HD_HDR, HD_SDR					NORMAL/PM
720/59.94p-120fps	HD_HDR		no signal	HD_HDR, HD_SDR					NORMAL/PM
<b>HS_HDR(50)</b>									
1080/50p-200fps	HS_3G_HDR, HS_HD_HDR			3G_HDR, 3G_SDR, HD_HDR, HD_SDR			HD_HDR, HD_SDR		NORMAL/PM
1080/50p-150fps	HS_3G_HDR, HS_HD_HDR		no signal	3G_HDR, 3G_SDR, HD_HDR, HD_SDR			HD_HDR, HD_SDR		NORMAL/PM
1080/50p-100fps	HS_3G_HDR, HS_HD_HDR		no signal	3G_HDR, 3G_SDR, HD_HDR, HD_SDR			HD_HDR, HD_SDR		NORMAL/PM
720/50p-200fps	HD_HDR			HD_HDR, HD_SDR					NORMAL/PM
720/50p-150fps	HD_HDR		no signal	HD_HDR, HD_SDR					NORMAL/PM
720/50p-100fps	HD_HDR		no signal	HD_HDR, HD_SDR					NORMAL/PM

## OUT FORMAT(HD\_HDR)

This is the selection screen for the OUT FORMAT(HD\_HDR) menu.

```

->*** OUT FORMAT(HD_HDR)(1/2)***

SDI OUT1-4          3G_HDR
SDI OUT1            3G_HDR
SDI OUT2            3G_HDR
SDI OUT3            3G_HDR
SDI OUT4            3G_HDR
SFP+ OUT            3G_HDR
SDI OUT5&6          HD_HDR
SDI OUT7            HD_HDR
SDI OUT8            HD_HDR
NORMAL/PM           NORMAL
3G SDI              LEVEL-A
  
```

```

->*** OUT FORMAT(HD_HDR)(2/2)***

HDR COLORIMETRY     BT.2020
  
```

\_\_\_ indicates factory default settings.

Item	Setting value	Setting details
<b>SDI OUT1-4</b> <b>SDI OUT1</b>	3G_HDR HD_HDR	Set the format of the signals to be output from [1] to [4] of the [UHD/HS/HD SDI OUT] connectors. <ul style="list-style-type: none"> <li>The content selected in SDI OUT1-4 is displayed for the items of SDI OUT1-4.</li> </ul> ➔ "Output selection conditions" (see page 65) [SFP+ OUT] is displayed when a MoIP board (AK-NP600) is connected. [SFP+ OUT] follows the [SDI OUT1-4] setting in the same way as [SDI OUT 1/2/3/4]. Output from SFP+ is enabled only when CCU MODE is set to [1080/59.94p], [720/59.94p], [1080/50p], or [720/50p].
<b>SDI OUT1-4</b> <b>SDI OUT2</b>	HD_SDR	
<b>SDI OUT1-4</b> <b>SDI OUT3</b>		
<b>SDI OUT1-4</b> <b>SDI OUT4</b>		
<b>SDI OUT1-4</b> <b>SFP+ OUT</b>		
<b>SDI OUT5&amp;6</b> <b>SDI OUT7</b>	3G_HDR 3G_SDR HD_HDR HD_SDR PsF_HDR TrueP_HDR OVER(3G)_HDR PsF_SDR TrueP_SDR OVER(3G)_SDR	
<b>SDI OUT8</b>	HD_HDR HD_SDR PsF_HDR PsF_SDR	Set the format of the signals to be output from [8/PM] of the [HD SDI OUT] connector. <b>When [CCU MODE] is [1080/29.97PsF], [1080/23.98PsF] or [1080/25PsF]:</b> PsF_HDR/PsF_SDR <b>When [CCU MODE] is other than [1080/29.97PsF], [1080/23.98PsF], [1080/25PsF]:</b> HD_HDR/HD_SDR ➔ "Output selection conditions" (see page 65)
<b>SDI OUT8</b> <b>NORMAL/PM</b>	PM NORMAL	Set the signal to be output from [8/PM] of the [HD SDI OUT] connector. ➔ Can only be set to PM when using a MoIP board (AK-NP600). <b>PM :</b> Output the picture monitor images. <b>NORMAL :</b> Output the main line images.
<b>3G SDI</b>	LEVEL-A LEVEL-B	Set the output format for 3G output.

Item	Setting value	Setting details
HDR COLORIMETRY	BT.709 BT.2020	Change the Y/C conversion coefficient.

### Output selection conditions

FORMAT/ CCU MODE	SDI								ANALOG
	OUT1	OUT2	OUT3	OUT4	OUT5	OUT6	OUT7	OUT8	COMPOSITE/ PM
<b>HD_HDR(59.94)</b>									
1080/59.94p	3G_HDR, HD_HDR, HD_SDR						HD_HDR, HD_SDR		NORMAL/PM
1080/29.97PsF	HD_HDR, HD_SDR				PsF_HDR, PsF_SDR, TrueP_HDR, TrueP_SDR, OVER(3G)_HDR, OVER(3G)_SDR		PsF_HDR, PsF_SDR		NORMAL/PM
1080/23.98PsF	HD_HDR, HD_SDR				PsF_HDR, PsF_SDR, TrueP_HDR, TrueP_SDR, OVER(3G)_HDR, OVER(3G)_SDR		PsF_HDR, PsF_SDR		NORMAL/PM
1080/23.98p over 59.94i	HD_HDR, HD_SDR						HD_HDR, HD_SDR		NORMAL/PM
1080/23PsF & over59i	HD_HDR, HD_SDR						HD_HDR, HD_SDR		NORMAL/PM
720/59.94p	HD_HDR, HD_SDR						HD_HDR, HD_SDR		NORMAL/PM
<b>HD_HDR(50)</b>									
1080/50p	3G_HDR, HD_HDR, HD_SDR						HD_HDR, HD_SDR		NORMAL/PM
1080/25PsF	HD_HDR, HD_SDR				PsF_HDR, PsF_SDR, TrueP_HDR, TrueP_SDR, OVER(3G)_HDR, OVER(3G)_SDR		PsF_HDR, PsF_SDR		NORMAL/PM
720/50p	HD_HDR, HD_SDR						HD_HDR, HD_SDR		NORMAL/PM

## With AK-NP600 option

FORMAT/ CCU MODE	SDI								SFP+
	OUT1	OUT2	OUT3	OUT4	OUT5	OUT6	OUT7	OUT8	1 / 2
<b>HD_HDR(59.94)</b>									
1080/59.94p	3G_HDR, HD_HDR, HD_SDR						HD_HDR, HD_SDR		3G_HDR/HD_HDR/HD_SDR
1080/23PsF & over59i	HD_HDR, HD_SDR						HD_HDR, HD_SDR		no signal
1080/23.98p over 59.94i	HD_HDR, HD_SDR						HD_HDR, HD_SDR		no signal
1080/29.97PsF	HD_HDR, HD_SDR				PsF_HDR, PsF_SDR, TrueP_HDR, TrueP_SDR, OVER_HDR, OVER_SDR		PsF_HDR, PsF_SDR		no signal
1080/23.98PsF	HD_HDR, HD_SDR				PsF_HDR, PsF_SDR, TrueP_HDR, TrueP_SDR, OVER_HDR, OVER_SDR		PsF_HDR, PsF_SDR		no signal
720/59.94p	HD_HDR, HD_SDR						HD_HDR, HD_SDR		HD
<b>HD_HDR(50)</b>									
1080/50p	3G_HDR, HD_HDR, HD_SDR						HD_HDR, HD_SDR		3G/HD PM
1080/25PsF	HD_HDR, HD_SDR				PsF_HDR, PsF_SDR, TrueP_HDR, TrueP_SDR, OVER_HDR, OVER_SDR		PsF_HDR, PsF_SDR		no signal
720/50p	HD_HDR, HD_SDR						HD_HDR, HD_SDR		HD

## SETTING(1/2)

This is the selection screen for the SETTING(1/2) menu.

```

->*** SETTING(1/2) ***

COMPOSITE/PM          PM
ANALOG PROMPT        1-OUT
RETURN FS             OFF
TRUNK1                RS422
TRUNK2                RS422
MONO SW              OFF
HD BAR SELECT        SMPTE
  BAR LPF             9TAP
  BAR USER1          100%WHITE
  BAR USER2          0%BLACK

```

\_\_\_ indicates factory default settings.

Item	Setting value	Setting details
COMPOSITE/PM	<u>PM</u> NORMAL	Set the signal to be output from [VBS PM OUT] connector. <ul style="list-style-type: none"> <li>● <b>PM</b> : Output the picture monitor images.</li> <li>● <b>NORMAL</b> : Output the main line images.</li> <li>● When [SDI OUT8] is set to [NORMAL] in the [OUTPUT FORMAT] menu, this will be fixed at [PM] to maintain the [SDI OUT8] or [COMPOSITE/PM] output picture monitor display.</li> </ul>
ANALOG PROMPT	<u>1-OUT</u> 2-IN	Set input/output for the [ANALOG PROMPT1 IN] and [ANALOG PROMPT2 IN/OUT] connectors. <ul style="list-style-type: none"> <li>● When [1-OUT] is selected, the signal input to the [ANALOG PROMPT1 IN] connector becomes the loop-through output. Apply termination on the connected device.</li> </ul>
RETURN FS	ON <u>OFF</u>	Set the delay mode for the HD return signals.
TRUNK1	<u>RS422</u>	Set the TRUNK1 line send/receive format of the [TRUNK] connector.
TRUNK2	RS232C	Set the TRUNK2 line send/receive format of the [TRUNK] connector.
MONO SW	ON <u>OFF</u>	Set CCU output video to monochrome.
HD BAR SELECT	STD <u>SMPTE</u> ARIB EIAJ SPLIT	Set the color bar signal for output with the HD signal.
HD BAR LPF	OFF 3TAP 5TAP 7TAP <u>9TAP</u>	Set the filter to be applied to the color bar signal output with the HD signal.
HD BAR USER1	75%WHITE <u>100%WHITE</u> +I_SIGNAL -I_SIGNAL	Set user selection 1 for when [ARIB] has been selected as the [HD BAR SELECT] setting.
HD BAR USER2	<u>0%BLACK</u> +Q_SIGNAL	Set user selection 2 for when [ARIB] has been selected as the [HD BAR SELECT] setting.

## SETTING(2/2)

This is the selection screen for the SETTING(2/2) menu.

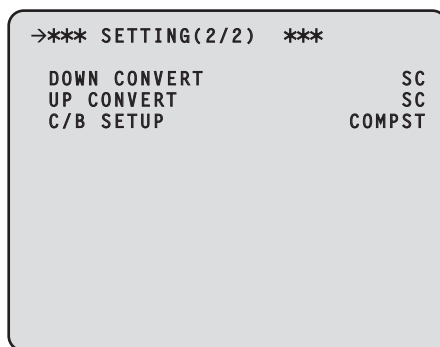

\_\_\_ indicates factory default settings.

Item	Setting value	Setting details
<b>DOWN CONVERT</b>	<u>SC</u> SQ LB LINK	Set the down-convert system. ➔ "Down-conversion mode settings" (see page 177)
<b>UP CONVERT</b>	<u>SC</u> SQ LB LINK	Set the up-convert system.
<b>C/B SETUP*1</b>	OFF <u>COMPST</u> SD_SDI BOTH	Set the SD signal output for use with color bar output. <ul style="list-style-type: none"> <li>This is only displayed when the format is 59.94 Hz.</li> </ul>

\*1: AK-UCU600P/600PS



## HD PHASE

This is the selection screen for the HD PHASE menu.

```

->*** HD PHASE ***

HD H COARSE      0
HD H FINE        0
V ADVANCE        0
  
```

\_\_\_ indicates factory default settings.

Item	Setting value	Setting details
<b>HD H COARSE</b>	-127 to <u>0</u> to +127	Make the coarse setting of the H_FINE phase used with GL HD REF.
<b>HD H FINE</b>	-100 to <u>0</u> to +100	Make the fine setting of the H_FINE phase used with GL HD REF.
<b>V ADVANCE</b>	-3 / -2 / -1 / <u>0</u>	<p>Set the vertical phase of this unit in relation to the vertical phase of the REF signal. The larger the negative value, the larger the advance. The setting unit varies depending on [CCU MODE].</p> <ul style="list-style-type: none"> <li>When the mode is [720/59p] or [720/50p], the setting unit is 1H of [720p].</li> <li>When the mode is [1080/23.98psF], the setting unit is 1H of [1080/23.98psF].</li> <li>Otherwise, the setting unit is 1H of [1080/59i] or [1080/50i].</li> </ul>

## SD PHASE

This is the selection screen for the SD PHASE menu.

```

->*** SD PHASE ***

SD H COARSE      0
SD H FINE        0
SD-HD V          0H
SCH              0
  
```

\_\_\_ indicates factory default settings.

Item	Setting value	Setting details
<b>SD H COARSE</b>	-30 to <u>0</u> to +30	Make the coarse setting of the H_FINE phase used with GL SD REF.
<b>SD H FINE</b>	-100 to <u>0</u> to +100	Make the fine setting of the H_FINE phase used with GL SD REF.
<b>SD-HD V</b>	<u>0H</u> ADVANCE 0H_SD_DLAY	<p>Set the vertical phase used with down-convert SD REF.</p> <ul style="list-style-type: none"> <li>With [1080/59.94i(24P)], this is fixed to [0H].</li> <li>With [720/59.94p] and [720/50p], this is fixed to [0H].</li> </ul>
<b>SCH</b>	-180 to <u>0</u> to +180	Adjust the SCH phase of VBS output.

**SD signal phase <1080i/59.94 Hz format>**

**SD-HD V item setting: 0H**

GEN LOCK BB (black burst) signal

- 3.58 BB (black burst) signal (525/59.94/I)

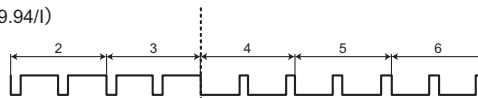

CCU\_VBS/SDI (SD)\_OUT

- VBS/SDI (SD) signal (525/59.94/I)

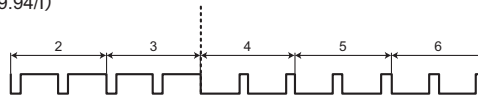

CCU\_HD\_SDI\_OUT

- HD\_SDI signal (1125/59.94/I)

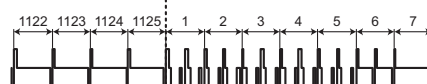

**SD-HD V item setting: ADVANCE (90H)**

GEN LOCK BB (black burst) signal

- 3.58 BB (black burst) signal (525/59.94/I)

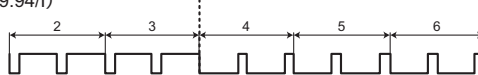

CCU\_VBS/SDI (SD)\_OUT

- VBS/SDI (SD) signal (525/59.94/I)

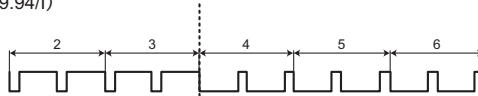

CCU\_HD\_SDI\_OUT

- HD\_SDI signal (1125/59.94/I)

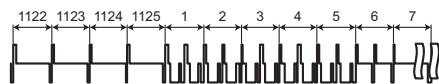

90H (HD) LINE

**SD-HD V item setting: 0H\_SD\_DLAY (1FRAME-90H DLY)**

GEN LOCK BB (black burst) signal

- 3.58 BB (black burst) signal (525/59.94/I)

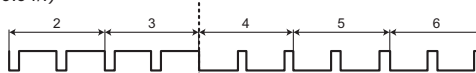

CCU\_VBS/SDI (SD)\_OUT

- VBS/SDI (SD) signal (525/59.94/I)

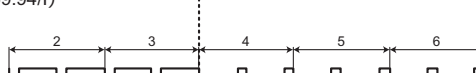

CCU\_HD\_SDI\_OUT

- HD\_SDI signal (1125/59.94/I)

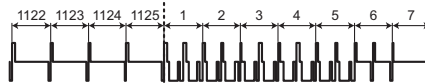

1FRAME-90H (HD) LINE

**SD signal phase <1080i/50 Hz format>**

**SD-HD V item setting: 0H**

GEN LOCK BB (black burst) signal

- 4.43 BB (black burst) signal (626/50/I)

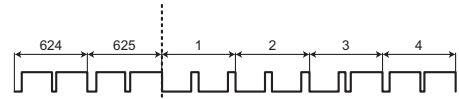

CCU\_VBS/SDI (SD)\_OUT

- VBS/SDI (SD) signal (626/50/I)

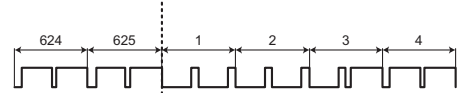

CCU\_HD\_SDI\_OUT

- HD\_SDI signal (1125/50/I)

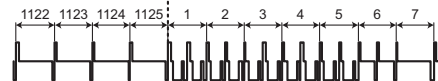

**SD-HD V item setting: ADVANCE (75H)**

GEN LOCK BB (black burst) signal

- 4.43 BB (black burst) signal (626/50/I)

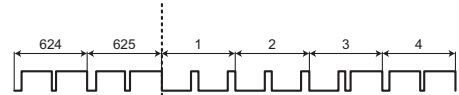

CCU\_VBS/SDI (SD)\_OUT

- VBS/SDI (SD) signal (626/50/I)

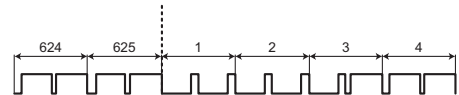

CCU\_HD\_SDI\_OUT

- HD\_SDI signal (1125/50/I)

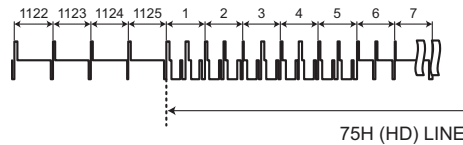

**SD-HD V item setting: 0H\_SD\_DLAY (1FRAME-75H DLY)**

GEN LOCK BB (black burst) signal

- 4.43 BB (black burst) signal (626/50/I)

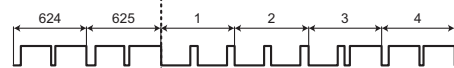

CCU\_VBS/SDI (SD)\_OUT

- VBS/SDI (SD) signal (626/50/I)

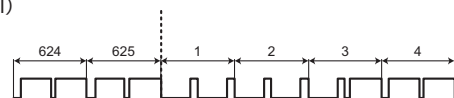

CCU\_HD\_SDI\_OUT

- HD\_SDI signal (1125/50/I)

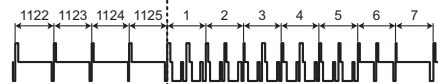

1FRAME-75H (HD) LINE

**HD signal phase <1080i/59.94 Hz format>**

**SD-HD V item setting: 0H**

GEN LOCK tri-level sync signal

CCU\_HD\_SDI\_OUT

CCU\_VBS/SDI (SD)\_OUT

- Tri-level sync signal  
(1125/59.94/I)

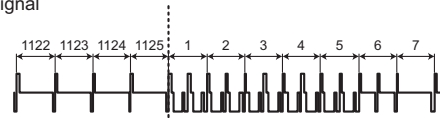

- HD\_SDI signal  
(1125/59.94/I)

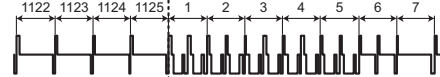

- VBS/SDI (SD) signal  
(525/59.94/I)

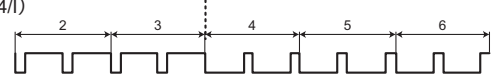

**SD-HD V item setting: ADVANCE (90H)**

GEN LOCK tri-level sync signal

CCU\_HD\_SDI\_OUT

CCU\_VBS/SDI (SD)\_OUT

- Tri-level sync signal  
(1125/59.94/I)

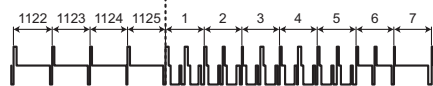

- HD\_SDI signal

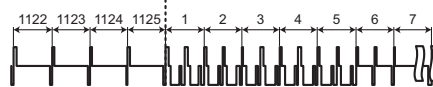

- VBS/SDI (SD) signal  
(525/59.94/I)

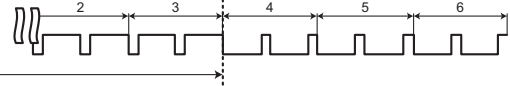

90H (HD) LINE

**SD-HD V item setting: 0H\_SD\_DLAY (1FRAME-90H DLY)**

GEN LOCK tri-level sync signal

CCU\_HD\_SDI\_OUT

CCU\_VBS/SDI (SD)\_OUT

- Tri-level sync signal  
(1125/59.94/I)

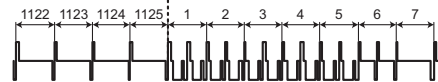

- HD\_SDI signal

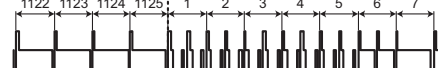

- VBS/SDI (SD) signal  
(525/59.94/I)

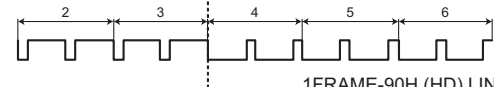

1FRAME-90H (HD) LINE

**HD signal phase <1080i/50 Hz format>**

**SD-HD V item setting: 0H**

GEN LOCK tri-level sync signal

CCU\_HD\_SDI\_OUT

CCU\_VBS/SDI (SD)\_OUT

- Tri-level sync signal (1125/50/I)

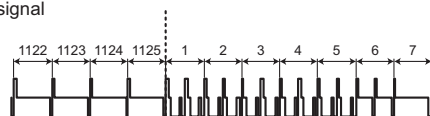

- HD\_SDI signal (1125/50/I)

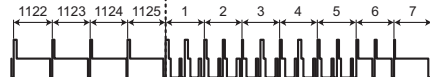

- VBS/SDI (SD) signal (626/50/I)



**SD-HD V item setting: ADVANCE (75H)**

GEN LOCK tri-level sync signal

CCU\_HD\_SDI\_OUT

CCU\_VBS/SDI (SD)\_OUT

- Tri-level sync signal (1125/50/I)

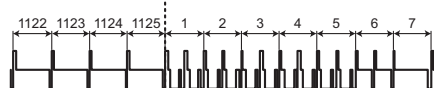

- HD\_SDI signal (1125/50/I)

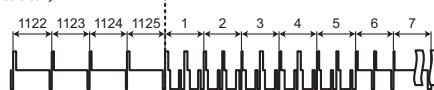

- VBS/SDI (SD) signal (626/50/I)

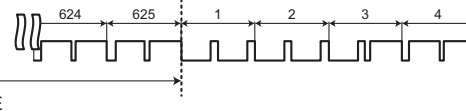

75H (HD) LINE

**SD-HD V item setting: 0H\_SD\_DLAY (1FRAME-75H DLY)**

GEN LOCK tri-level sync signal

CCU\_HD\_SDI\_OUT

CCU\_VBS/SDI (SD)\_OUT

- Tri-level sync signal (1125/50/I)

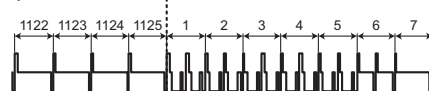

- HD\_SDI signal (1125/50/I)

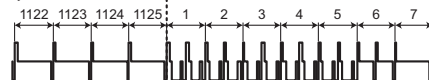

- VBS/SDI (SD) signal (626/50/I)

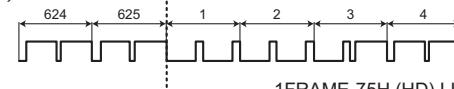

1FRAME-75H (HD) LINE

## BAR ID

This is the selection screen for the BAR ID menu.

```

->*** BAR ID ***

BAR ID SWITCH           OFF
BRIGHTNESS             100%
ID1 POSITION             V:00 H:00

ID1                    ##

ID2 POSITION             V:01 H:00

ID2                    ___
OFFSET                 V:00 H:00
HS PHASE MARKER SW     OFF
  
```

\_\_\_ indicates factory default settings.

Item	Setting value	Setting details
<b>BAR ID SWITCH</b>	ON OFF	Set display of the camera ID in the color bar ON or OFF.
<b>BRIGHTNESS</b>	0 to <u>100%</u>	Set the text color for the camera ID in the color bar. <ul style="list-style-type: none"> <li>The setting can be made in 10% steps.</li> <li>0 : Black</li> <li>100%: White</li> </ul>
<b>ID1 POSITION V</b>	<u>00</u> to 05	Set the starting position (vertical) for display of camera ID1 in the color bar. <ul style="list-style-type: none"> <li>Set from which character in the vertical direction, starting from the top left of the color bar, to start displaying the BAR ID using the font size as the reference.</li> </ul>
<b>ID1 POSITION H</b>	<u>00</u> to 15	Set the starting position (horizontal) for display of camera ID1 in the color bar. <ul style="list-style-type: none"> <li>Set from which character in the horizontal direction in the color bar to start displaying the BAR ID using the font size as the reference.</li> </ul>
<b>ID1</b>	<u>##</u> (Max. 16 characters)	Set camera ID1. This ID is displayed in the color bar. <b>Characters which can be used:</b> Alphanumeric characters, spaces, ! # % & ' ( ) * + , - . / : ; < = > ? [ ] _ ~ <ul style="list-style-type: none"> <li>If "##" is input, that portion is replaced with the camera number (1 to 15) being managed by the CCU.</li> </ul>
<b>ID2 POSITION V</b>	00, <u>01</u> to 05	Set the starting position (vertical) for display of camera ID2 in the color bar. <ul style="list-style-type: none"> <li>Set from which character in the vertical direction, starting from the top left of the color bar, to start displaying the BAR ID using the font size as the reference.</li> </ul>
<b>ID2 POSITION H</b>	<u>00</u> to 15	Set the starting position (horizontal) for display of camera ID2 in the color bar. <ul style="list-style-type: none"> <li>Set from which character in the horizontal direction in the color bar to start displaying the BAR ID using the font size as the reference.</li> </ul>
<b>ID2</b>	<u>Spaces</u> (Max. 16 characters)	Set camera ID2. This ID is displayed in the color bar. <b>Characters which can be used:</b> Alphanumeric characters, spaces, ! # % & ' ( ) * + , - . / : ; < = > ? [ ] _ ~ <ul style="list-style-type: none"> <li>If "##" is input, that portion is replaced with the camera number (1 to 99) being managed by the CCU.</li> </ul>
<b>OFFSET V</b>	00 to 89	Specify the origin (upper left) in the vertical direction of the character drawing area in pixels.
<b>OFFSET H</b>	<u>00</u> to 79	Specify the origin (upper left) in the horizontal direction of the character drawing area in pixels.
<b>HS PHASE MARKER SW</b>	ON OFF	Set whether PHASE MARKER is multiplexed in the color bar when HS is set.

### NOTE

- When the coordinates of ID1 and ID2 are the same, BAR ID1's character string will be placed on top of BAR ID2 (BAR ID2 will be on the bottom). When the vertical coordinates are the same and the horizontal coordinates differ, the BAR ID with the horizontal coordinates set later will be placed on top.

## SELECT RETURN

This is the selection screen for the SELECT RETURN menu.

```

->*** SELECT RETURN ***

SELECT RETURN1      RET1
SELECT RETURN2      RET2
SELECT RETURN3      RET3
SELECT RETURN4      RET4
  
```

\_\_\_ indicates factory default settings.

Item	Setting value	Setting details
<b>SELECT RETURN1</b>	RET1 RET2 RET3 RET4 VBS	Set the input assignment of the return signals. Can only be set to RET1 when SFP+ is selected.
<b>SELECT RETURN2</b>	RET1 <u>RET2</u> RET3 RET4 VBS	
<b>SELECT RETURN3</b>	RET1 RET2 <u>RET3</u> RET4 VBS	
<b>SELECT RETURN4</b>	RET1 RET2 RET3 <u>RET4</u> VBS	

## MONITOR

This is the selection screen for the MONITOR menu.

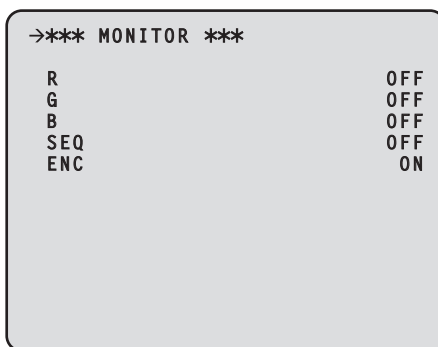

\_\_\_ indicates factory default settings.

Item	Setting value	Setting details
R	OFF ON	For the setting details, see the following table. ➔ "MONITOR menu setting and operation" (see page 76)  ON can be set for [R], [G], and [B] simultaneously. Select one of [R], [G] or [B], and one of [SEQ] or [ENC].  • When [SEQ] and [ENC] are set to [ON], [R], [G], and [B] will be set to [OFF]. When [SEQ] and [ENC] are set to [OFF], [R], [G], and [B] will return to their previous configuration.
G	OFF ON	
B	OFF ON	
SEQ	OFF ON	
ENC	OFF ON	

### MONITOR menu setting and operation

The MONITOR menu (R/G/B/SEQ/ENC) operates as follows according to its setting.

MONITOR menu	HDTV		SDTV	Remarks
	SDI8/PM	VBS/PM	VBS/PM	
R	R	R	R	Output R instead of Y. P <sub>B</sub> P <sub>R</sub> and chroma signals OFF.
G	G	G	G	Output G instead of Y. P <sub>B</sub> P <sub>R</sub> and chroma signals OFF.
B	B	B	B	Output B instead of Y. P <sub>B</sub> P <sub>R</sub> and chroma signals OFF.
SEQ	YP <sub>B</sub> P <sub>R</sub>	Y	Y	Chroma signal OFF for VBS output.
ENC	YP <sub>B</sub> P <sub>R</sub>	VIDEO	VIDEO	Output normal color images.



## SETTING(MOIP)

This is the selection screen for the SETTING(MOIP).

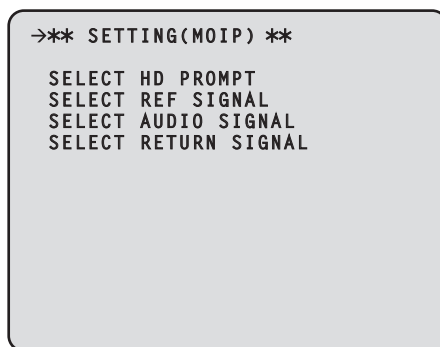

\_\_\_ indicates factory default settings.

Item	Setting value	Setting details
<b>SELECT HD PROMPT</b>	SDI SFP+	Selects the input connector for HD prompter signals.
<b>SELECT REF SIGNAL</b>	SDI PTP	Selects the input connector for reference signals.
<b>SELECT AUDIO SIGNAL</b>	NORMAL SFP+	Selects the input/output connector for audio signals.
<b>SELECT RETURN SIGNAL</b>	SDI SFP+	Selects the input connector for the return signals.

## UHD SETTING

This is the selection screen for the UHD SETTING menu.

\* This is available only when the UC3000 is connected.

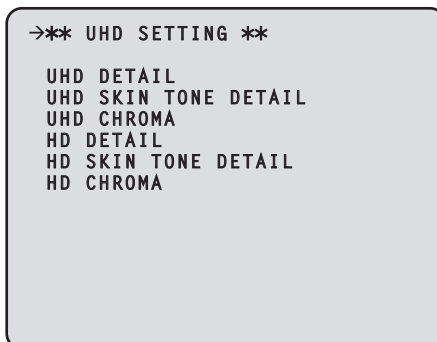

Item	Content	Details page
UHD DETAIL	Display the UHD DETAIL menu.	➔ "UHD DETAIL" (see page 78)
UHD SKIN TONE DETAIL	Display the UHD SKIN TONE DETAIL menu.	➔ "UHD SKIN TONE DETAIL(1/2)" (see page 79)
UHD CHROMA	Display the UHD CHROMA menu.	➔ "UHD CHROMA" (see page 80)
HD DETAIL	Display the HD DETAIL menu.	➔ "HD DETAIL(1/2)" (see page 81)
HD SKIN TONE DETAIL	Display the HD SKIN TONE DETAIL menu.	➔ "HD SKIN TONE DTL(1/2)" (see page 83)
HD CHROMA	Display the HD CHROMA menu.	➔ "HD CHROMA" (see page 84)

## UHD DETAIL

This is the selection screen for the UHD DETAIL menu.

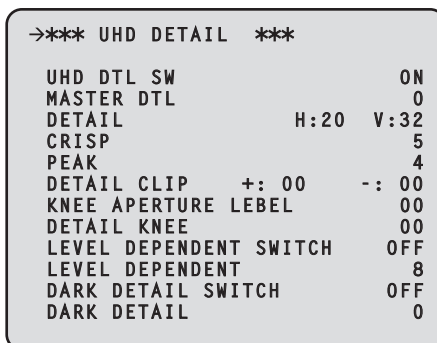

\_\_\_ indicates factory default settings.

Item	Setting value	Setting details
UHD DTL SW	OFF ON	Enable/disable the detail function.
MASTER DTL	-31 to <u>0</u> to +31	Set the master detail.
H-DETAIL	0 to <u>20</u> to 63	Set the horizontal detail correction level.
V-DETAIL	0 to <u>32</u> to 63	Set the vertical detail correction level.
CRISP	0 to <u>5</u> to 63	Set the noise elimination level for the detail signals.
PEAK	1 to <u>4</u> to 5	Set the peak frequency of the horizontal detail.
DETAIL CLIP+	<u>00</u> to +63	Adjust detail clipping to minimize any roughness that results from excessive detail application.
DETAIL CLIP-	<u>00</u> to +63	This limits the length of the undershoot portion of the detail edge component.
KNEE APERTURE LEVEL	<u>00</u> to 39	Adjust the knee aperture level. <ul style="list-style-type: none"> <li>For HDR format, this is fixed at [5].</li> </ul>
DETAIL KNEE	<u>00</u> to 15	Adjust the knee detail component.
LEVEL DEPENDENT SWITCH	OFF ON	Enable/disable the function for removing details in dark areas. <ul style="list-style-type: none"> <li>For HDR format, this is fixed at [OFF].</li> </ul>
LEVEL DEPENDENT	00 to <u>8</u> to 15	Set the level of dark detail removal.
DARK DETAIL SWITCH	OFF ON	Enable/disable the function for enhancing details in dark areas. <ul style="list-style-type: none"> <li>For HDR format, this is fixed at [OFF].</li> </ul>
DARK DETAIL	<u>0</u> to 7	Set the level of dark detail enhancement.

## UHD SKIN TONE DETAIL(1/2)

This is the selection screen for the UHD SKIN TONE DETAIL(1/2) menu.

->*** UHD SKIN TONE DTL(1/2) ***	
SKIN TONE DETAIL	OFF
SKIN GET	
MEMORY SELECT	A
CURSOR	OFF
POSITION H : 000.00	V : 000.00
GET	
ZEBRA	OFF
ZEBRA EFFECT MEMORY	A
SKIN TONE EFFECT MEMORY	A
SKIN TONE CRISP	0

\_\_\_ indicates factory default settings.

Item	Setting value	Setting details
<b>SKIN TONE DETAIL</b>	<u>OFF</u> ON	Enable/disable the skin tone detail function.
<b>SKIN GET</b>		
▶MEMORY SELECT	A B C	Select the skin color table for the subject to which the skin tone table is applied.
▶CURSOR	<u>OFF</u> ON	Set display of the box cursor at screen center to ON or OFF.
▶POSITION H	0 to <u>50</u> to 100.00	Adjust the horizontal position of the cursor.
▶POSITION V	0 to <u>50</u> to 100.00	Adjust the vertical position of the cursor.
▶GET	<u>NO</u> YES	Select whether to automatically acquire saturation and hue information from the cursor position.
<b>ZEBRA</b>	<u>OFF</u> ON	Enable/disable the zebra display.
▶ZEBRA EFFECT MEMORY	A B C A+B A+C B+C A+B+C	Select the zebra display table.
<b>SKIN TONE EFFECT MEMORY</b>	A B C A+B A+C B+C A+B+C	Select the skin color table used when applying skin tone detail.
<b>SKIN TONE CRISP</b>	-63 to <u>+63</u>	Adjust the skin tone detail.

## UHD SKIN TONE DETAIL(2/2)

This is the selection screen for the UHD SKIN TONE DETAIL(2/2) menu.

->*** UHD SKIN TONE DTL(2/2) ***	
I CENTER	87
I WIDTH	20
Q WIDTH	43
Q PHASE	90

\_\_\_ indicates factory default settings.

Item	Setting value	Setting details
<b>I CENTER</b>	000 to <u>87</u> to 255	Set the center position (area to which skin tone is applied) on the I axis.
<b>I WIDTH</b>	000 to <u>20</u> to 255	Set the width of the area to which skin tone is applied on the I axis using the [I CENTER] setting as the center.
<b>Q WIDTH</b>	000 to <u>43</u> to 255	Set the width of the area to which skin tone is applied on the Q axis using the [I CENTER] setting as the center.
<b>Q PHASE</b>	0 to <u>90</u> to 359	Set the phase of the area to which the skin tone effect is applied, with the Q axis being the reference.

## UHD CHROMA

This is the selection screen for the UHD CHROMA menu.

->*** UHD CHROMA ***	
CHROMA LEVEL SWITCH	OFF
CHROMA LEVEL	0%

\_\_\_ indicates factory default settings.

Item	Setting value	Setting details
<b>CHROMA LEVEL SWITCH</b>	OFF ON	Enable/disable gain adjustment for chroma.
<b>CHROMA LEVEL</b>	-100% to <u>0%</u> to +40%	Set the chroma gain adjustment.

## HD DETAIL(1/2)

This is the selection screen for the HD DETAIL(1/2) menu.

```

->*** HD DETAIL(1/2) ***
DETAIL                ON
MASTER DETAIL        0
DETAIL LEVEL          H:15 V:15
PEAKE FREQUENCY      15.0
V DETAIL FREQUENCY    10
CRISP                 10
DETAIL GAIN (+):      0 (-): 0
DETAIL CLIP (+):      0 (-): 0
DETAIL SOURCE          (G+R)/2
KNEE APETURE LEVEL    00
DETAIL KNEE           00
  
```

\_\_\_ indicates factory default settings.

Item	Setting value	Setting details
<b>DETAIL</b>	OFF ON	Enable/disable the detail function.
<b>MASTER DETAIL</b>	-31 to <u>0</u> to 31	Set the master detail.
<b>DETAIL LEVEL H</b>	00 to <u>15</u> to 63	Set the horizontal detail correction level.
<b>DETAIL LEVEL V</b>	00 to <u>15</u> to 63	Set the vertical detail correction level.
<b>PEAK FREQUENCY</b>	12.4 / 12.5 / 12.7 / 12.9 / 13.0 / 13.3 / 13.6 / 13.9 / 14.2 / 14.6 / <u>15.0</u> / 15.5 / 16.1 / 16.7 / 17.3 / 18.3 / 18.6 / 18.8 / 19.0 / 19.2 / 19.5 / 19.9 / 20.3 / 20.9 / 21.5 / 22.4 / 23.6 / 25.4 / 28.6 / 37.1	Set the peak frequency of the horizontal detail.
<b>V DETAIL FREQUENCY</b>	00 to <u>10</u> to 31	Set the vertical detail frequency.
<b>CRISP</b>	00 to <u>10</u> to 63	Set the noise elimination level for the detail signals.
<b>DETAIL GAIN (+)</b>	-31 to <u>0</u> to +31	Increase (+) the detail level.
<b>DETAIL GAIN (-)</b>	-31 to <u>0</u> to +31	Decrease (-) the detail level.
<b>DETAIL CLIP (+)</b>	<u>00</u> to +63	Adjust detail clipping to minimize any roughness that results from excessive detail application.
<b>DETAIL CLIP (-)</b>	<u>00</u> to +63	This limits the length of the undershoot portion of the detail edge component.
<b>DETAIL SOURCE</b>	(G+R)/2 (G+B)/2 (2G+B+R)/4 (3G+R)/4 R G	Set the RGB signal component ratio used for detail creation.
<b>KNEE APETURE LEVEL</b>	<u>00</u> to 39	Adjust the knee aperture level. ● For HDR format, this is fixed at [5].
<b>DETAIL KNEE</b>	<u>00</u> to 15	Adjust the knee detail component.

## HD DETAIL(2/2)

This is the selection screen for the HD DETAIL(2/2) menu.

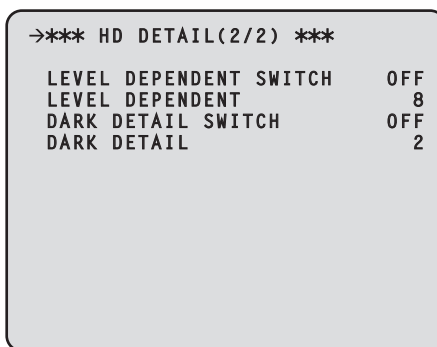

\_\_\_ indicates factory default settings.

Item	Setting value	Setting details
<b>LEVEL DEPENDENT SWITCH</b>	OFF ON	Enable/disable the function for removing details in dark areas. <ul style="list-style-type: none"> <li>For HDR format, this is fixed at [OFF].</li> </ul>
<b>LEVEL DEPENDENT</b>	00 to <u>8</u> to 15	Set the level of dark detail removal.
<b>DARK DETAIL SWITCH</b>	OFF ON	Enable/disable the function for enhancing details in dark areas. <ul style="list-style-type: none"> <li>For HDR format, this is fixed at [OFF].</li> </ul>
<b>DARK DETAIL</b>	00 to <u>2</u> to 7	Set the level of dark detail enhancement.

## HD SKIN TONE DTL(1/2)

This is the selection screen for the HD SKIN TONE DTL(1/2) menu.

```

->*** HD SKIN TONE DTL(1/2) ***
SKIN TONE DETAIL      OFF
SKIN GET
MEMORY SELECT        A
CURSOR               OFF
POSITION   H:000.00 V:000.00
GET
ZEBRA                OFF
ZEBRA EFFECT MEMORY  A
SKIN TONE EFFECT MEMORY  A
SKIN TONE CRISP      0
  
```

\_\_\_ indicates factory default settings.

Item	Setting value	Setting details
<b>SKIN TONE DETAIL</b>	<u>OFF</u> ON	Enable/disable the skin tone detail function.
<b>SKIN GET</b>		
▶MEMORY SELECT	<u>A</u> B C	Select the skin color table used when applying skin tone detail.
▶CURSOR	<u>OFF</u> ON	Set display of the box cursor at screen center to ON or OFF.
▶POSITION H	0 to <u>50</u> to 100.00	Adjust the horizontal position of the cursor.
▶POSITION V	0 to <u>50</u> to 100.00	Adjust the vertical position of the cursor.
▶GET	<u>NO</u> YES	Select whether to automatically acquire saturation and hue information from the cursor position.
<b>ZEBRA</b>	<u>OFF</u> ON	Enable/disable the zebra display.
▶ZEBRA EFFECT MEMORY	<u>A</u> B C A +B A+C B+C A+B+C	Select the zebra display table.
<b>SKIN TONE EFFECT MEMORY</b>	<u>A</u> B C A+B A+C B+C A+B+C	Select the skin color table used when applying skin tone detail.
<b>SKIN TONE CRISP</b>	-63 to <u>+63</u>	Adjust the skin tone detail.

## HD SKIN TONE DTL(2/2)

This is the selection screen for the HD SKIN TONE DTL(2/2) menu.

->*** HD SKIN TONE DTL(2/2) ***	
I CENTER	87
I WIDTH	20
Q WIDTH	43
Q PHASE	90

\_\_\_ indicates factory default settings.

Item	Setting value	Setting details
I CENTER	000 to <u>87</u> to 255	Set the center position (area to which skin tone is applied) on the I axis.
I WIDTH	000 to <u>20</u> to 255	Set the width of the area to which skin tone is applied on the I axis using the [I CENTER] setting as the center.
Q WIDTH	000 to <u>43</u> to 255	Set the width of the area to which skin tone is applied on the Q axis using the [I CENTER] setting as the center.
Q PHASE	0 to <u>90</u> to 359	Set the phase of the area to which the skin tone effect is applied, with the Q axis being the reference.

## HD CHROMA

This is the selection screen for the HD CHROMA menu.

->*** HD CHROMA ***	
CHROMA LEVEL SWITCH	OFF
CHROMA LEVEL	0%

\_\_\_ indicates factory default settings.

Item	Setting value	Setting details
CHROMA LEVEL SWITCH	OFF ON	Enable/disable gain adjustment for chroma.
CHROMA LEVEL	-100% to <u>0%</u> to +40%	Set the chroma gain adjustment.



## AUDIO

This is the selection screen for the AUDIO menu.

```

->*** AUDIO ***

MIC OUT
CCU INTERCOM TALK
CCU INTERCOM RECEIVE
STANDBY INTERCOM
COMMUNICATION
INTERCOM1
INTERCOM2
PGM

FORMAT(MOIP)

```

Item	Content	Details page
MIC OUT	Display the MIC OUT menu.	➔ "MIC OUT" (see page 85)
CCU INTERCOM TALK	Display the CCU INTERCOM TALK menu.	➔ "CCU INTERCOM TALK" (see page 86)
CCU INTERCOM RECEIVE	Display the CCU INTERCOM RECEIVE menu.	➔ "CCU INTERCOM RECEIVE" (see page 86)
STANDBY INTERCOM	Display the STBY INTERCOM menu.	➔ "STBY INTERCOM" (see page 87)
COMMUNICATION	Display the COMMUNICATION menu.	➔ "COMMUNICATION" (see page 87)
INTERCOM1	Display the INTERCOM1 menu.	➔ "INTERCOM1" (see page 88)
INTERCOM2	Display the INTERCOM2 menu.	➔ "INTERCOM2" (see page 89)
PGM	Display the PGM menu.	➔ "PGM" (see page 90)
FORMAT(MOIP)	Sets the audio input and output formats for MOIP. (Enabled only when option AK-NP600 is attached.)	➔ "FORMAT(MOIP)" (see page 91)

## MIC OUT

This is the selection screen for the MIC OUT menu.

```

->*** MIC OUT ***

MIC1 OUT  GAIN: 0dB  LV: 0dB
MIC2 OUT  GAIN: 0dB  LV: 0dB

```

\_\_\_ indicates factory default settings.

Item	Setting value	Setting details
MIC1 OUT GAIN	0dB +4dB	This switches the analog output gain for MIC1.
MIC1 OUT LV	-40dB to 0dB to +20dB	This adjusts the analog output level for MIC1.
MIC2 OUT GAIN	0dB +4dB	This switches the analog output gain for MIC2.
MIC2 OUT LV	-40dB to 0dB to +20dB	This adjusts the analog output level for MIC2.

## CCU INTERCOM TALK

This is the selection screen for the CCU INTERCOM TALK menu.

```

->*** CCU INTERCOM TALK ***

MIC TYPE           DYN
MIC POWER          OFF
MIC GAIN           0dB
SIDE TONE         -6dB
CCU INCOM ON/OFF  ON
  
```

\_\_\_ indicates factory default settings.

Item	Setting value	Setting details
MIC TYPE	<u>DYN</u> ECM CBN	Select the type of intercom microphone.
MIC POWER	ON <u>OFF</u>	Set the power supply of the intercom microphone to ON or OFF.
MIC GAIN	-40dB to <u>0dB</u> to +12dB (1dB Step)	This is the volume control of the intercom microphone.
SIDE TONE	OFF -36dB to <u>-6dB</u> to 0dB	This is the volume control of the intercom microphone side tone.
CCU INCOM ON/OFF	ON <u>OFF</u>	Set the intercom to ON or OFF.

## CCU INTERCOM RECEIVE

This is the selection screen for the CCU INTERCOM RECEIVE menu.

```

->*** CCU INTERCOM RECEIVE ***

CCU INCOM VR MIN MD  MUTE
PGM VR MIN MODE      MUTE
CCU INCOM OUT GAIN   Normal
ENG MIX CH2          OFF
PROD MIX CH2          OFF
PGM1 MIX CH2          OFF
PGM2 MIX CH2          OFF
  
```

\_\_\_ indicates factory default settings.

Item	Setting value	Setting details
CCU INCOM VR MIN MD	<u>MUTE</u> MIN_GAIN	Set the minimum intercom volume level.
PGM VR MIN MODE	<u>MUTE</u> MIN_GAIN	Set the minimum PGM volume level.
CCU INCOM OUT GAIN	<u>Normal</u> Boost	Switch the intercom output level.
ENG MIX CH2	ON <u>OFF</u>	Set whether to mix the ENG signal with the intercom's CH2 output.
PROD MIX CH2	ON <u>OFF</u>	Set whether to mix the PROD signal with the intercom's CH2 output.
PGM1 MIX CH2	ON <u>OFF</u>	Set whether to mix the PGM1 signal with the intercom's CH2 output.
PGM2 MIX CH2	ON <u>OFF</u>	Set whether to mix the PGM2 signal with the intercom's CH2 output.

## STBY INTERCOM

This is the selection screen for the STBY INTERCOM menu.

```

->*** STBY INTERCOM ***

INPUT LEVEL           0dB
OUTPUT LEVEL          0dB
CANCEL LEVEL          0.0dB
STBY INCOM ON/OFF    ON
  
```

\_\_\_ indicates factory default settings.

Item	Setting value	Setting details
<b>INPUT LEVEL</b>	-40dB to <u>0dB</u> to +20dB (1dB Step)	Set the standby intercom input signal level.
<b>OUTPUT LEVEL</b>	-40dB to <u>0dB</u> to +20dB (1dB Step)	Set the standby intercom output signal level.
<b>CANCEL LEVEL</b>	-20.0dB to +20.0dB *1 (0.5dB Step)	Set the standby intercom I/O cancellation signal level.
<b>STBY INCOM ON/OFF</b>	<u>ON</u> OFF	Set the standby intercom to ON or OFF.

\*1: The default setting varies depending on adjustment at the factory.

## COMMUNICATION

This is the selection screen for the COMMUNICATION menu.

```

->*** COMMUNICATION ***

INCOM1 ENG/PROD      ENG
INCOM2 ENG/PROD      PROD
PRIV/SYSTEM SW       ENG
  
```

\_\_\_ indicates factory default settings.

Item	Setting value	Setting details
<b>INCOM1 ENG/PROD</b>	ENG <u>PROD</u>	Set the intercom 1 voice line of the communication connector.
<b>INCOM2 ENG/PROD</b>	ENG <u>PROD</u>	Set the intercom 2 voice line of the communication connector.
<b>PRIV/SYSTEM SW</b>	<u>ENG</u> PROD BOTH OFF INCOM1 INCOM2	Set the voice assignment of the [PRIV/SYSTEM] switch.

## INTERCOM1

This is the selection screen for the INTERCOM1 menu.

```

->*** INTERCOM1 ***

 4W/RTS/CLRCOM          4W
 4W INPUT GAIN          0dB
 4W INPUT LEVEL         0dB
 4W OUTPUT LEVEL       0dB
 RTS INPUT LEVEL        0dB
 RTS OUTPUT LEVEL      0dB
 RTS CANCEL LEVEL      0.0dB
 CLRCOM INPUT LEVEL     0dB
 CLRCOM OUTPUT LEVEL   0dB
 CLRCOM CANCEL LEVEL   0.0dB
 RST/CLRCOM LOAD       OFF
  
```

\_\_\_ indicates factory default settings.

Item	Setting value	Setting details
<b>4W/RTS/CLRCOM</b>	4W RTS CLRCOM	Select the intercom 1 voice I/O method.
<b>4W INPUT GAIN</b>	0dB 20dB	Switch the 4W (intercom 1) input gain.
<b>4W INPUT LEVEL</b>	-40dB to 0dB to +20dB (1dB Step)	Switch the 4W (intercom 1) input level.
<b>4W OUTPUT LEVEL</b>	-40dB to 0dB to +20dB (1dB Step)	Switch the 4W (intercom 1) output level.
<b>RTS INPUT LEVEL</b>	-40dB to 0dB to +20dB (1dB Step)	Switch the RTS (intercom 1) input level.
<b>RTS OUTPUT LEVEL</b>	-40dB to 0dB to +20dB (1dB Step)	Switch the RTS (intercom 1) output level.
<b>RTS CANCEL LEVEL</b>	-20.0dB to +20.0dB *1 (0.5dB Step)	Switch the RTS (intercom 1) I/O cancellation level.
<b>CLRCOM INPUT LEVEL</b>	-40dB to 0dB to +20dB (1dB Step)	Set the clear-com (intercom 1) input volume.
<b>CLRCOM OUTPUT LEVEL</b>	-40dB to 0dB to +20dB (1dB Step)	Set the clear-com (intercom 1) output volume.
<b>CLRCOM CANCEL LEVEL</b>	-20.0dB to +20.0dB *1 (0.5dB Step)	Adjust the clear-com (intercom 1) I/O cancellation signal level.
<b>RTS/CLRCOM LOAD</b>	ON OFF	Switch ON or OFF for the intercom 1 RTS/CLRCOM 200 Ω load.

\*1: The default setting varies depending on adjustment at the factory.

## INTERCOM2

This is the selection screen for the INTERCOM2 menu.

```

->*** INTERCOM2 ***

 4W/RTS/CLRCOM          4W
 4W INPUT GAIN           0dB
 4W INPUT LEVEL          0dB
 4W OUTPUT LEVEL        0dB
 RTS INPUT LEVEL         0dB
 RTS OUTPUT LEVEL       0dB
 RTS CANCEL LEVEL       0.0dB
 CLRCOM INPUT LEVEL     0dB
 CLRCOM OUTPUT LEVEL    0dB
 CLRCOM CANCEL LEVEL    0.0dB
 RST/CLRCOM LOAD        OFF
  
```

\_\_\_ indicates factory default settings.

Item	Setting value	Setting details
<b>4W/RTS/CLRCOM</b>	4W RTS CLRCOM	Select the intercom 2 voice I/O method.
<b>4W INPUT GAIN</b>	0dB 20dB	Switch the 4W (intercom 2) input gain.
<b>4W INPUT LEVEL</b>	-40dB to 0dB to +20dB (1dB Step)	Switch the 4W (intercom 2) input level.
<b>4W OUTPUT LEVEL</b>	-40dB to 0dB to +20dB (1dB Step)	Switch the 4W (intercom 2) output level.
<b>RTS INPUT LEVEL</b>	-40dB to 0dB to +20dB (1dB Step)	Switch the RTS (intercom 2) input level.
<b>RTS OUTPUT LEVEL</b>	-40dB to 0dB to +20dB (1dB Step)	Switch the RTS (intercom 2) output level.
<b>RTS CANCEL LEVEL</b>	-20.0dB to +20.0dB *1 (0.5dB Step)	Switch the RTS (intercom 2) I/O cancellation level.
<b>CLRCOM INPUT LEVEL</b>	-40dB to 0dB to +20dB (1dB Step)	Set the clear-com (intercom 2) input volume.
<b>CLRCOM OUTPUT LEVEL</b>	-40dB to 0dB to +20dB (1dB Step)	Set the clear-com (intercom 2) output volume.
<b>CLRCOM CANCEL LEVEL</b>	-20.0dB to +20.0dB *1 (0.5dB Step)	Adjust the clear-com (intercom 2) I/O cancellation signal level.
<b>RTS/CLRCOM LOAD</b>	ON OFF	Switch ON or OFF for the intercom 2 RTS/CLRCOM 200 Ω load.

\*1: The default setting varies depending on adjustment at the factory.

## PGM

This is the selection screen for the PGM menu.

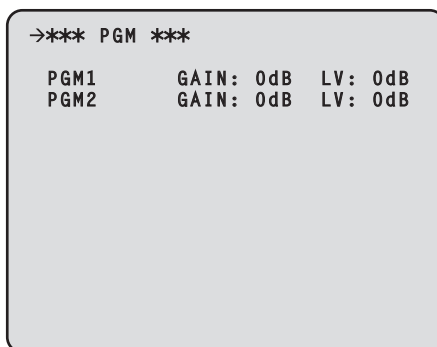

\_\_\_ indicates factory default settings.

Item	Setting value	Setting details
<b>PGM1 GAIN</b>	0 <u>dB</u> 20dB	Switch the PGM1 input gain.
<b>PGM1 LV</b>	-40dB to 0 <u>dB</u> to +20dB	Set the PGM1 input volume.
<b>PGM2 GAIN</b>	0 <u>dB</u> 20dB	Switch the PGM2 input gain.
<b>PGM2 LV</b>	-40dB to 0 <u>dB</u> to +20dB	Set the PGM2 input volume.

## FORMAT(MOIP)

This is the selection screen for the FORMAT(MOIP) menu.

```

->*** FORMAT(MOIP) ***

MIC1 TX FORMAT :      1ms/8ch
MIC2 TX FORMAT :      1ms/8ch
PGM1 RX FORMAT :      1ms/8ch
PGM2 RX FORMAT :      1ms/8ch

INCOM1 TX FORMAT :    1ms/8ch
INCOM2 TX FORMAT :    1ms/8ch
INCOM1 RX FORMAT :    1ms/8ch
INCOM2 RX FORMAT :    1ms/8ch

```

Item	Setting value	Setting details
<b>MIC1 TX FORMAT</b>	[1ms/2ch], [1ms/4ch], [1ms/8ch], [0.125ms/2ch], [0.125ms/4ch], [0.125ms/8ch], [0.125ms/16ch], [0.125ms/64ch]	Sets the format for MIC1 output.
<b>MIC2 TX FORMAT</b>	[1ms/2ch], [1ms/4ch], [1ms/8ch], [0.125ms/2ch], [0.125ms/4ch], [0.125ms/8ch], [0.125ms/16ch], [0.125ms/64ch]	Sets the format for MIC2 output.
<b>PGM1 RX FORMAT</b>	[1ms/2ch], [1ms/4ch], [1ms/8ch], [0.125ms/2ch], [0.125ms/4ch], [0.125ms/8ch], [0.125ms/16ch], [0.125ms/64ch]	Sets the format for PGM1 input.
<b>PGM2 RX FORMAT</b>	[1ms/2ch], [1ms/4ch], [1ms/8ch], [0.125ms/2ch], [0.125ms/4ch], [0.125ms/8ch], [0.125ms/16ch], [0.125ms/64ch]	Sets the format for PGM2 input.
<b>INCOM1 TX FORMAT</b>	[1ms/2ch], [1ms/4ch], [1ms/8ch], [0.125ms/2ch], [0.125ms/4ch], [0.125ms/8ch], [0.125ms/16ch], [0.125ms/64ch]	Sets the format for INCOM1 output.
<b>INCOM2 TX FORMAT</b>	[1ms/2ch], [1ms/4ch], [1ms/8ch], [0.125ms/2ch], [0.125ms/4ch], [0.125ms/8ch], [0.125ms/16ch], [0.125ms/64ch]	Sets the format for INCOM2 output.
<b>INCOM1 RX FORMAT</b>	[1ms/2ch], [1ms/4ch], [1ms/8ch], [0.125ms/2ch], [0.125ms/4ch], [0.125ms/8ch], [0.125ms/16ch], [0.125ms/64ch]	Sets the format for INCOM1 input.
<b>INCOM2 RX FORMAT</b>	[1ms/2ch], [1ms/4ch], [1ms/8ch], [0.125ms/2ch], [0.125ms/4ch], [0.125ms/8ch], [0.125ms/16ch], [0.125ms/64ch]	Sets the format for INCOM2 input.

## MAINTENANCE

This is the selection screen for the MAINTENANCE menu.

```

->** MAINTENANCE **

START UP
SETUP
AUX
ANALOG GAIN
ND/CC NAME
NETWORK
NETWORK(MOIP)
VERSION
PM VIEW SETTING
PM OPERATION STATUS
SYSTEM
SD CARD

```

Item	Content	Details page
<b>START UP</b>	Display the START UP menu.	➔ "START UP" (see page 93)
<b>SETUP</b>	Display the SETUP menu.	➔ "SETUP" (see page 93)
<b>AUX</b>	Display the AUX menu.	➔ "AUX" (see page 95)
<b>ANALOG GAIN</b>	Display the ANALOG GAIN menu.	➔ "ANALOG GAIN" (see page 96)
<b>ND/CC NAME*1</b>	Display the ND/CC NAME menu.	➔ "ND/CC NAME(1/2)" (see page 96)
<b>NETWORK*2</b>	Display the NETWORK menu.	➔ "NETWORK(1/2)" (see page 98)
<b>NETWORK(MOIP)</b>	Changes the NETWORK settings to use when using a MoIP board (AK-NP600).	➔ "NETWORK(MOIP)" (see page 99)
<b>VERSION</b>	Display the VERSION menu.	➔ "VERSION" (see page 111)
<b>PM VIEW SETTING</b>	Display the PM VIEW SETTING menu.	➔ "PM VIEW SETTING(1/2)" (see page 112)
<b>PM OPERATION STATUS</b>	Display the PM OPERATION STATUS menu.	➔ "PM OPERATION STATUS" (see page 114)
<b>SYSTEM*1</b>	Display the SYSTEM menu.	➔ "SYSTEM" (see page 115)
<b>SD CARD*1</b>	Display the SD CARD menu.	➔ "SD CARD" (see page 117)

\*1: Displayed as "ND NAME" when AK-UC3300 is connected.

\*2: Cannot be selected until unit startup is complete (i.e., about 1 minute after turning the power on).



## START UP

This is the selection screen for the START UP menu.

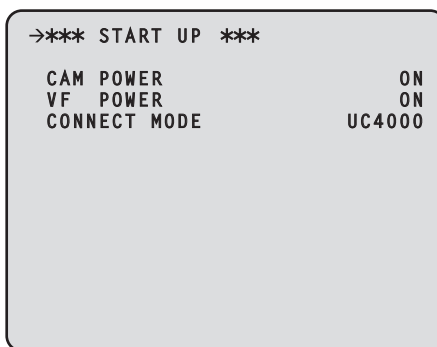

\_\_\_ indicates factory default settings.

Item	Setting value	Setting details
<b>CAM POWER</b>	OFF ON REMOTE	Set the control of the camera's power that is to be performed when the unit's power is turned on.  <b>OFF</b> The camera's power will not come on even when the unit's power is turned on. In this case, "HEAD POWER" on the operation panel of the ROP or [CAMERA POWER] on the unit must be set to ON.  <b>ON</b> The camera's power will come on when the unit's power is turned on.  <b>REMOTE</b> Turns on in the same state as when the CCU power was turned OFF.
<b>VF POWER</b>	OFF ON REMOTE	Set the control of the viewfinder's power that is performed when the unit's power is turned on.  <b>OFF</b> The viewfinder's power will not come on even when the unit's power is turned on. In this case, "VF POWER" must be set to ON on the operation panel of the ROP.  <b>ON</b> Turning on the power of this unit also turns on the power of the viewfinder.  <b>REMOTE</b> Turns on in the same state as when the CCU power was turned OFF.
<b>CONNECT MODE</b>	UC4000 UC3000 UC3300	Set the unit to connect to AK-UC4000, AK-UC3000, or AK-UC3300 when turning on the power of this unit.  <b>UC4000</b> Connect to the AK-UC4000.  <b>UC3000</b> Connect to the AK-UC3000.  <b>UC3300</b> Connect to the AK-UC3300.

## SETUP

This is the selection screen for the SETUP menu.

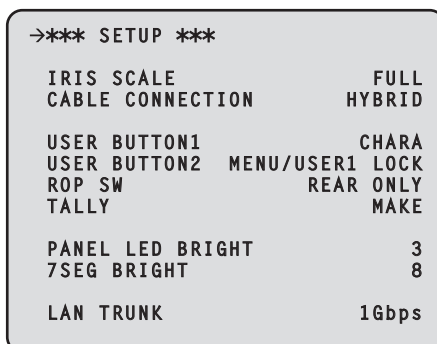

\_\_\_ indicates factory default settings.

Item	Setting value	Setting details
<b>IRIS SCALE</b>	FULL 2STOP	Set the IRIS display range of the status display screen.

Item	Setting value	Setting details
<b>CABLE CONNECTION</b>	<u>HYBRID</u> FIBER	Sets the cable used to connect the camera. <b>HYBRID</b> Select this when connecting the camera using an optical fiber multi cable. <b>FIBER</b> Select this when connecting the camera using only optical fiber. When [FIBER] is selected, power will not be supplied to the camera. In addition, the "OPEN" and "SHORT" errors will not be displayed.
<b>USER BUTTON1</b>	NONE <u>CHARA</u> BARS CLEAN	Set the function to be assigned to the [USER1] button on the front panel. <b>NONE</b> No assignment <b>CHARA</b> Character display, operation <b>BARS</b> Color bar ON/OFF <b>CLEAN</b> PM/NORM selection for SDI8 OUT
<b>USER BUTTON2</b>	NONE CHARA <u>MENU/USER1</u> <u>LOCK</u> BARS CLEAN	Set the function to be assigned to the [USER2] button on the front panel. <b>NONE</b> No assignment <b>CHARA</b> Character display, operation <b>MENU/USER1 LOCK</b> Invalidate [MENU] button, [USER1] button (Function is assigned, but nothing happens when button pressed.) <b>BARS</b> Color bar ON/OFF <b>CLEAN</b> PM/NORM selection for SDI8 OUT
<b>ROP SW</b>	<u>FRONT ONLY</u> <u>REAR ONLY</u> SWITCH SELECT	Sets the connector used to connect ROP. <b>FRONT ONLY</b> Allows connection via the front panel only, regardless of the switch. <b>REAR ONLY</b> Allows connection via the rear panel only, regardless of the switch. <b>SWITCH SELECT</b> The setting will be determined by the front panel switch setting.
<b>TALLY</b>	<u>MAKE</u> V	Select the input format for the TALLY signal. <b>MAKE</b> When the circuit between the TALLY IN H terminal and TALLY IN C terminal is OPEN, TALLY is OFF, and when it is MAKE, TALLY is ON. <ul style="list-style-type: none"> <li>The TALLY IN H terminal is internally pulled up to +5 V with a 2.2 K resistor through a protective diode. The maximum current is 20 mA or less.</li> </ul> <b>V</b> When voltage is applied to the TALLY IN H terminal, TALLY is ON, and when voltage is not applied, TALLY is OFF. Connect TALLY IN C to GND. <ul style="list-style-type: none"> <li>A resistor of about 12.4 kΩ is inserted between TALLY IN H and TALLY IN C. The maximum voltage that can be applied is 24 V, and the maximum current is 20 mA.</li> </ul>
<b>PANEL LED BRIGHT</b>	1 to <u>3</u> to 5	Sets the brightness of the front panel indicators.
<b>7SEG BRIGHT</b>	1 to <u>8</u> to 15	Sets the brightness of the 7-segment indicators.
<b>LAN TRUNK</b>	<u>1Gbps</u> 100Mbps	Sets the communication speed for when LAN TRUNK is used.

## AUX

This is the selection screen for the AUX menu.

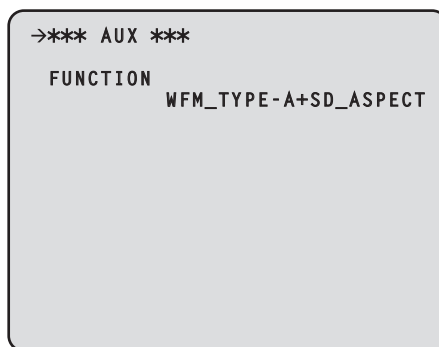

\_\_\_ indicates factory default settings.

Item	Setting value	Setting details
<b>FUNCTION</b>	WFM_TYPE-A+SD_ASPECT WFM_TYPE-B+SD_ASPECT AUDIO GAIN+SD_ASPECT	Switch the function of the [AUX] connector.  <b>WFM_TYPE-A+SD_ASPECT / WFM_TYPE-B+SD_ASPECT</b> Waveform monitor control output and down-conversion input  <b>AUDIO GAIN+SD_ASPECT</b> Camera's MIC gain control output and down-conversion input ➡ "Down-conversion mode settings" (see page 177) ➡ "AUDIO GAIN settings" (see page 177)

### Selecting connected waveform monitors

Configure the type of waveform monitor (WFM) to connect to the [AUX] connector as follows.

Setting value	Control mode
<b>TYPE-A</b>	Coded Mode
<b>TYPE-B</b>	Direct Mode

- There are two types of waveform monitor (WFM) you can connect.
- You can recall presets for the waveform monitor in the [MONITOR] menu.  
Waveform monitor presets must be configured on the waveform monitor beforehand.  
Depending on the model, connection of the waveform monitor to the unit may require cable connections other than those described.

### Relationship between the MONITOR menu and waveform monitor preset numbers

By using the preset function of the waveform monitor, you can load the waveform monitor's waveform display settings.

MONITOR menu setting	Preset setting numbers of waveform monitor
<b>R</b>	Preset1
<b>B</b>	Preset2
<b>G</b>	Preset3
<b>R+B+G</b>	Preset4
<b>R+B</b>	
<b>R+G</b>	
<b>B+G</b>	
<b>SEQ</b>	Preset5
<b>ENC</b>	Preset6

- For details on the controls that correspond to the preset numbers set on the waveform monitor, consult your dealer.

## ANALOG GAIN

This is the selection screen for the ANALOG GAIN menu.

```

->*** ANALOG GAIN ***

VBS                0
VBS/PM             0
PROMPT1            0
PROMPT2            0
  
```

Item	Setting value	Setting details
VBS	-50 to +50	Set the signal level to be output from [VBS OUT] connector.
VBS/PM	-50 to +50	Set the signal level to be output from [VBS PM OUT] connector.
PROMPT1	-50 to +50	Set the ANALOG PROMPT 1 signal level.
PROMPT2	-50 to +50	Set the ANALOG PROMPT 2 signal level.

## ND/CC NAME(1/2)

This is the selection screen for the ND/CC NAME(1/2) menu.

```

->*** ND/CC NAME(1/2) ***

ND FILTER_1 NAME   1
ND FILTER_2 NAME   2
ND FILTER_3 NAME   3
ND FILTER_4 NAME   4
ND FILTER_5 NAME   5
  
```

Item	Setting value	Setting details
ND FILTER_1 NAME	5 characters (Factory setting: 1)	Set the name (maximum 5 characters) of ND filter 1 (CAP). The name set here is displayed in the status display (STATUS2).  <b>Characters which can be used:</b> Alphanumeric characters, spaces, ! # % & ' ( ) * + , - . / : ; < = > ? [ ] _ ~
ND FILTER_2 NAME	5 characters (Factory setting: 2)	Set the name (maximum 5 characters) of ND filter 2 (CLEAR). The name set here is displayed in the status display (STATUS2).  <b>Characters which can be used:</b> Alphanumeric characters, spaces, ! # % & ' ( ) * + , - . / : ; < = > ? [ ] _ ~
ND FILTER_3 NAME	5 characters (Factory setting: 3)	Set the name (maximum 5 characters) of ND filter 3 (1/4). The name set here is displayed in the status display (STATUS2).  <b>Characters which can be used:</b> Alphanumeric characters, spaces, ! # % & ' ( ) * + , - . / : ; < = > ? [ ] _ ~
ND FILTER_4 NAME	5 characters (Factory setting: 4)	Set the name (maximum 5 characters) of ND filter 4 (1/16). The name set here is displayed in the status display (STATUS2).  <b>Characters which can be used:</b> Alphanumeric characters, spaces, ! # % & ' ( ) * + , - . / : ; < = > ? [ ] _ ~
ND FILTER_5 NAME	5 characters (Factory setting: 5)	Set the name (maximum 5 characters) of ND filter 5 (1/64). The name set here is displayed in the status display (STATUS2).  <b>Characters which can be used:</b> Alphanumeric characters, spaces, ! # % & ' ( ) * + , - . / : ; < = > ? [ ] _ ~

### NOTE

- When AK-UC3300 and AK-PLV100 are connected, the display for "ND/CC NAME" changes to "ND NAME" and [ND FILTER 5 NAME] is not displayed.

## ND/CC NAME(2/2)

This is the selection screen for the ND/CC NAME(2/2) menu.

```

->*** ND/CC NAME(2/2) ***
  CC FILTER_1 NAME      A
  CC FILTER_2 NAME      B
  CC FILTER_3 NAME      C
  CC FILTER_4 NAME      D
  CC FILTER_5 NAME      E
  
```

Item	Setting value	Setting details
<b>CC FILTER_1 NAME</b>	5 characters (Factory setting: A)	Set the name (maximum 5 characters) of CC filter 1 (3200K). The name set here is displayed in the status display (STATUS2). <b>Characters which can be used:</b> Alphanumeric characters, spaces, ! # % & ' ( ) * + , - . / : ; < = > ? [ ] _ ~
<b>CC FILTER_2 NAME</b>	5 characters (Factory setting: B)	Set the name (maximum 5 characters) of CC filter 2 (4300K). The name set here is displayed in the status display (STATUS2). <b>Characters which can be used:</b> Alphanumeric characters, spaces, ! # % & ' ( ) * + , - . / : ; < = > ? [ ] _ ~
<b>CC FILTER_3 NAME</b>	5 characters (Factory setting: C)	Set the name (maximum 5 characters) of CC filter 3 (6300K). The name set here is displayed in the status display (STATUS2). <b>Characters which can be used:</b> Alphanumeric characters, spaces, ! # % & ' ( ) * + , - . / : ; < = > ? [ ] _ ~
<b>CC FILTER_4 NAME</b>	5 characters (Factory setting: D)	Set the name (maximum 5 characters) of CC filter 4 (CROSS). The name set here is displayed in the status display (STATUS2). <b>Characters which can be used:</b> Alphanumeric characters, spaces, ! # % & ' ( ) * + , - . / : ; < = > ? [ ] _ ~
<b>CC FILTER_5 NAME</b>	5 characters (Factory setting: E)	Set the name (maximum 5 characters) of CC filter 5 (DF0). The name set here is displayed in the status display (STATUS2). <b>Characters which can be used:</b> Alphanumeric characters, spaces, ! # % & ' ( ) * + , - . / : ; < = > ? [ ] _ ~

### NOTE

- When AK-UC3300 and AK-PLV100 are connected, "ND/CC NAME(2/2)" is not displayed.

## NETWORK(1/2)

This is the selection screen for the NETWORK(1/2) menu.

```

->*** NETWORK(1/2) ***

IP ADDRESS      192.168.  0. 20
SUBNETMASK      255.255.255.  0
DEFAULT GATEWAY 192.168.  0.  1

HTTP PORT      00080
ROP PORT       49152
SET EXECUTE
MAC ADDRESS    FF-FF-FF-FF-FF-FF
  
```

\_\_\_ indicates factory default settings.

Item	Setting value	Setting details
IP ADDRESS	(Factory setting: 192.168.0.20)	Set the IP address. <ul style="list-style-type: none"> <li>Select and set each set of three digits with the cursor.</li> </ul>
SUBNETMASK	(Factory setting: 255.255.255.0)	Set the subnet mask.
DEFAULT GATEWAY	(Factory setting: 192.168.0.1)	Set the default gateway.
HTTP PORT	00001 to 00080 to 65535	Set the port number used for web access.
ROP PORT	49152 to 49200 to 49299	Set the port number used for connecting to the ROP.
SET EXECUTE	-	When you press the [SELECT] button, [NETWORK SET EXECUTE NO/YES] appears. Select [YES] to apply the configured [NETWORK] information to the unit. If this operation is not performed, the changed [NETWORK] settings will not be applied. In addition, if you exit the menu without performing this operation, the settings will return to their original values.
MAC ADDRESS	Display only	Displays the MAC address.

## NETWORK(2/2)

This is the selection screen for the NETWORK(2/2) menu.

```

->*** NETWORK(2/2) ***

IP TALLY
INDEX NO:      1
PORT:          62000

SET EXECUTE
  
```

\_\_\_ indicates factory default settings.

Item		Setting value	Setting details
IP TALLY	INDEX NO	1 to 254 (Factory setting: 1)	Sets the INDEX NO set by devices that output TALLY.
	PORT	60000 to 65535 (Factory setting: 62000)	Sets the PORT number for TALLY IN.
SET EXECUTE		-	When you press the [SELECT] button, [NETWORK(2/2) SET EXECUTE NO/YES] appears. Select [YES] to apply the configured [NETWORK(2/2)] information to the unit. If this operation is not performed, the changed [NETWORK(2/2)] settings will not be applied. In addition, if you exit the menu without performing this operation, the settings will return to their original values.

## NETWORK(MOIP)

This is the selection screen for the NETWORK(MOIP) menu.

```

->*** NETWORK(MOIP) ***

SFP+ PRIMARY
SFP+ PRIMARY TX
SFP+ PRIMARY RX
SFP+ SECONDARY
SFP+ SECONDARY TX
SFP+ SECONDARY RX
1GbE
TALLY IN SETTING
PTP SETTING
NMOS SETTING

```

Item	Content
<b>SFP+ PRIMARY</b>	Displays the SFP+ PRIMARY setting menu.
<b>SFP+ PRIMARY TX</b>	Displays the SFP+ PRIMARY TX signal setting menu.
<b>SFP+ PRIMARY RX</b>	Displays the SFP+ PRIMARY RX signal setting menu.
<b>SFP+ SECONDARY</b>	Displays the SFP+ SECONDARY setting menu.
<b>SFP+ SECONDARY TX</b>	Displays the SFP+ SECONDARY TX signal setting menu.
<b>SFP+ SECONDARY RX</b>	Displays the SFP+ SECONDARY RX signal setting menu.
<b>1GbE</b>	Displays the 1GbE (LAN2) setting menu.
<b>TALLY IN SETTING</b>	Displays the TALLY IN setting menu.
<b>PTP SETTING</b>	Displays the PTP setting menu.
<b>NMOS SETTING</b>	Displays the NMOS setting menu.

## NETWORK(SFP+ PRM)

This is the selection screen for the NETWORK(SFP+ PRM) menu.

```

->*** NETWORK(SFP+ PRM)***

main
DHCP                OFF
IP ADDR             192.168.0.50
PORT                49300

SUBNETMASK          255.255.255.0
DEFAULT GATEWAY     192.168.0.1
SET EXECUTE
MAC ADDR            FF-FF-FF-FF-FF-FF

```

Item	Setting value	Setting details
<b>main</b>		
▶DHCP	OFF, ON (Factory setting: OFF)	Enables/disables DHCP.
▶IP ADDR	(Factory setting: 192.168.0.50)	Sets the IP address for SFP+ primary.
▶PORT	(Factory setting: 49300)	Sets the PORT for SFP+ primary.
<b>SUBNETMASK</b>	(Factory setting: 255.255.255.0)	Sets the subnet mask.
<b>DEFAULT GATEWAY</b>	(Factory setting: 192.168.0.1)	Sets the default gateway.
<b>SET EXECUTE</b>	-	When you press the [SELECT] button, [NETWORK(PRM) SET EXECUTE NO/YES] appears. Select [YES] to apply the configured [NETWORK(SFP+ PRM)] information to the unit. If this operation is not performed, the changed [NETWORK(SFP+ PRM)] settings will not be applied. In addition, if you exit the menu without performing this operation, the settings will return to their original values.
<b>MAC ADDR</b>	Display only	Displays the MAC address.

**NETWORK(SFP+ PRM TX)**

This is the selection screen for the NETWORK(SFP+ PRM TX) menu.

```

->> NETWORK(SFP+ PRM TX) 1/2

MAIN VIDEO TX
IP ADDR          224.1.0.1
PORT            49301
MONITOR VIDEO TX
IP ADDR          224.1.0.2
PORT            49302
HD TRUNK TX
IP ADDR          224.1.0.10
PORT            49310
MIC1 AUDIO TX
IP ADDR          224.1.0.3
PORT            49303

->> NETWORK(SFP+ PRM TX) 2/2

MIC2 AUDIO TX
IP ADDR          224.1.0.11
PORT            49311
INCOM1 AUDIO TX
IP ADDR          224.1.0.12
PORT            49312
INCOM2 AUDIO TX
IP ADDR          224.1.0.13
PORT            49313

SET EXECUTE

```

Item	Setting value	Setting details
<b>MAIN VIDEO TX</b>		This is the setting for the main line output video.
▶IP ADDR	(Factory setting: 224.1.0.1)	Sets the IP address for MAIN VIDEO TX.
▶PORT	01024 to 65535 (Factory setting: 49301) (Setting 10670 is prohibited.)	Sets the PORT for MAIN VIDEO TX.
<b>MONITOR VIDEO TX</b>		This is the setting for the monitor output video.
▶IP ADDR	(Factory setting: 224.1.0.2)	Sets the IP address for MONITOR VIDEO TX.
▶PORT	01024 to 65535 (Factory setting: 49302) (Setting 10670 is prohibited.)	Sets the PORT for MONITOR VIDEO TX.
<b>HD TRUNK TX</b>		This is the setting for the HD TRUNK TX.
▶IP ADDR	(Factory setting: 224.1.0.10)	Sets the IP address for HD TRUNK TX.
▶PORT	01024 to 65535 (Factory setting: 49310) (Setting 10670 is prohibited.)	Sets the PORT for HD TRUNK TX.
<b>MIC1 AUDIO TX</b>		This is the setting for the MIC1 output.
▶IP ADDR	(Factory setting: 224.1.0.3)	Sets the IP address for MIC1 AUDIO TX.
▶PORT	01024 to 65535 (Factory setting: 49303) (Setting 10670 is prohibited.)	Sets the PORT for MIC1 AUDIO TX.
<b>MIC2 AUDIO TX</b>		This is the setting for the MIC2 output.
▶IP ADDR	(Factory setting: 224.1.0.11)	Sets the IP address for MIC2 AUDIO TX.
▶PORT	01024 to 65535 (Factory setting: 49311) (Setting 10670 is prohibited.)	Sets the PORT for MIC2 AUDIO TX.
<b>INCOM1 AUDIO TX</b>		This is the setting for the INCOM1 output.
▶IP ADDR	(Factory setting: 224.1.0.12)	Sets the IP address for INCOM1 AUDIO TX.
▶PORT	01024 to 65535 (Factory setting: 49312) (Setting 10670 is prohibited.)	Sets the PORT for INCOM1 AUDIO TX.
<b>INCOM2 AUDIO TX</b>		This is the setting for the INCOM2 output.
▶IP ADDR	(Factory setting: 224.1.0.13)	Sets the IP address for INCOM2 AUDIO TX.
▶PORT	01024 to 65535 (Factory setting: 49313) (Setting 10670 is prohibited.)	Sets the PORT for INCOM2 AUDIO TX.
<b>SET EXECUTE</b>	-	When you press the [SELECT] button, [NETWORK(PRM TX) SET EXECUTE NO/YES] appears. Select [YES] to apply the configured [NETWORK(SFP+ PRM TX)] information to the unit. If this operation is not performed, the changed [NETWORK(SFP+ PRM TX)] settings will not be applied. In addition, if you exit the menu without performing this operation, the settings will return to their original values.



**NETWORK(SFP+ PRM RX)**

This is the selection screen for the NETWORK(SFP+ PRM RX) menu.

```

->> NETWORK(SFP+ PRM RX) 1/3

RET VIDEO RX
MCAST ADDR      224.1.0.4
SOURCE ADDR     0.0.0.0
PORT            49304
HD PROMPTER RX
MCAST ADDR      224.1.0.14
SOURCE ADDR     0.0.0.0
PORT            49314

SET EXECUTE
  
```

```

->> NETWORK(SFP+ PRM RX) 2/3

PGM1 AUDIO RX
MCAST ADDR      224.1.0.16
SOURCE ADDR     0.0.0.0
PORT            49316
PGM2 AUDIO RX
MCAST ADDR      224.1.0.17
SOURCE ADDR     0.0.0.0
PORT            49317

SET EXECUTE
  
```

```

->> NETWORK(SFP+ PRM RX) 3/3

INCOM1 AUDIO RX
MCAST ADDR      224.1.0.18
SOURCE ADDR     0.0.0.0
PORT            49318
INCOM2 AUDIO RX
MCAST ADDR      224.1.0.19
SOURCE ADDR     0.0.0.0
PORT            49319

SET EXECUTE
  
```

Item	Setting value	Setting details
<b>RET VIDEO RX</b>		This is the setting for the return video input.
▶MCAST ADDR	(Factory setting: 224.1.0.4)	Sets the IP address for RET VIDEO RX.
▶SOURCE ADDR	(Factory setting: 0.0.0.0)	Set to 0.0.0.0 if no limitations on multicast source are to be implemented. If you want to establish a source address, set the relevant address.
▶PORT	01024 to 65535 (Factory setting: 49304) (Setting 10670 is prohibited.)	Sets the PORT for HD PROMPTER RX.
<b>HD PROMPTER RX</b>		This is the setting for the HD PROMPTER input.
▶MCAST ADDR	(Factory setting: 224.1.0.14)	Sets the IP address for HD PROMPTER RX.
▶SOURCE ADDR	(Factory setting: 0.0.0.0)	Set to 0.0.0.0 if no limitations on multicast source are to be implemented. If you want to establish a source address, set the relevant address.
▶PORT	01024 to 65535 (Factory setting: 49314) (Setting 10670 is prohibited.)	Sets the PORT for HD PROMPTER RX.
<b>SET EXECUTE</b>	-	When you press the [SELECT] button, [NETWORK(PRM RX) SET EXECUTE NO/YES] appears. Select [YES] to apply the configured [NETWORK(SFP+ PRM RX)] information to the unit. If this operation is not performed, the changed [NETWORK(SFP+ PRM RX)] settings will not be applied. In addition, if you exit the menu without performing this operation, the settings will return to their original values.

Item	Setting value	Setting details
<b>PGM1 AUDIO RX</b>		This is the setting for the PGM1 input.
▶MCAST ADDR	(Factory setting: 224.1.0.16)	Sets the IP address for PGM1 AUDIO RX.
▶SOURCE ADDR	(Factory setting: 0.0.0.0)	Set to 0.0.0.0 if no limitations on multicast source are to be implemented. If you want to establish a source address, set the relevant address.
▶PORT	01024 to 65535 (Factory setting: 49316) (Setting 10670 is prohibited.)	Sets the PORT for PGM1 AUDIO RX.
<b>PGM2 AUDIO RX</b>		This is the setting for the PGM2 input.
▶MCAST ADDR	(Factory setting: 224.1.0.17)	Sets the IP address for PGM2 AUDIO RX.
▶SOURCE ADDR	(Factory setting: 0.0.0.0)	Set to 0.0.0.0 if no limitations on multicast source are to be implemented. If you want to establish a source address, set the relevant address.
▶PORT	01024 to 65535 (Factory setting: 49317) (Setting 10670 is prohibited.)	Sets the PORT for PGM2 AUDIO RX.
<b>SET EXECUTE</b>	-	When you press the [SELECT] button, [NETWORK(PRM RX) SET EXECUTE NO/YES] appears. Select [YES] to apply the configured [NETWORK(SFP+ PRM RX)] information to the unit. If this operation is not performed, the changed [NETWORK(SFP+ PRM RX)] settings will not be applied. In addition, if you exit the menu without performing this operation, the settings will return to their original values.
<b>INCOM1 AUDIO RX</b>		This is the setting for the INCOM1 input.
▶MCAST ADDR	(Factory setting: 224.1.0.18)	Sets the IP address for INCOM1 AUDIO RX.
▶SOURCE ADDR	(Factory setting: 0.0.0.0)	Set to 0.0.0.0 if no limitations on multicast source are to be implemented. If you want to establish a source address, set the relevant address.
▶PORT	01024 to 65535 (Factory setting: 49318) (Setting 10670 is prohibited.)	Sets the PORT for INCOM1 AUDIO RX.
<b>INCOM2 AUDIO RX</b>		This is the setting for the INCOM2 input.
▶MCAST ADDR	(Factory setting: 224.1.0.19)	Sets the IP address for INCOM2 AUDIO RX.
▶SOURCE ADDR	(Factory setting: 0.0.0.0)	Set to 0.0.0.0 if no limitations on multicast source are to be implemented. If you want to establish a source address, set the relevant address.
▶PORT	01024 to 65535 (Factory setting: 49319) (Setting 10670 is prohibited.)	Sets the PORT for INCOM2 AUDIO RX.
<b>SET EXECUTE</b>	-	When you press the [SELECT] button, [NETWORK(PRM RX) SET EXECUTE NO/YES] appears. Select [YES] to apply the configured [NETWORK(SFP+ PRM RX)] information to the unit. If this operation is not performed, the changed [NETWORK(SFP+ PRM RX)] settings will not be applied. In addition, if you exit the menu without performing this operation, the settings will return to their original values.

**NETWORK(SFP+ SCD)**

This is the selection screen for the NETWORK(SFP+ SCD) menu.

```

->*** NETWORK(SFP+ SCD) ***

main
DHCP                OFF
IP ADDR             192.168.0.51
PORT                49309

SUBNETMASK
                    255.255.255.0
DEFAULT GATEWAY    192.168.0.1

SET EXECUTE
MAC ADDR           FF-FF-FF-FF-FF-FF

```

Item	Setting value	Setting details
<b>main</b>		
▶DHCP	OFF, ON (Factory setting: OFF)	Enables/disables DHCP.
▶IP ADDR	(Factory setting: 192.168.0.51)	Sets the IP address for SFP+ SECONDARY.
▶PORT	(Factory setting: 49309)	Sets the PORT for SFP+ SECONDARY.
<b>SUBNETMASK</b>	(Factory setting: 255.255.255.0)	Sets the subnet mask.
<b>DEFAULT GATEWAY</b>	(Factory setting: 192.168.0.1)	Sets the default gateway.
<b>SET EXECUTE</b>	-	When you press the [SELECT] button, [NETWORK(SCD) SET EXECUTE NO/YES] appears. Select [YES] to apply the configured [NETWORK(SFP+ SCD)] information to the unit. If this operation is not performed, the changed [NETWORK(SFP+ SCD)] settings will not be applied. In addition, if you exit the menu without performing this operation, the settings will return to their original values.
<b>MAC ADDR</b>	Display only	Displays the MAC address.

**NETWORK(SFP+ SCD TX)**

This is the selection screen for the NETWORK(SFP+ SCD TX) menu.

->> NETWORK(SFP+ SCD TX) 1/2	
MAIN VIDEO TX	
IP ADDR	224.1.0.5
PORT	49305
MONITOR VIDEO TX	
IP ADDR	224.1.0.6
PORT	49306
HD TRUNK TX	
IP ADDR	224.1.0.20
PORT	49320
MIC1 AUDIO TX	
IP ADDR	224.1.0.7
PORT	49307
->> NETWORK(SFP+ SCD TX) 2/2	
MIC2 AUDIO TX	
IP ADDR	224.1.0.21
PORT	49321
INCOM1 AUDIO TX	
IP ADDR	224.1.0.22
PORT	49322
INCOM2 AUDIO TX	
IP ADDR	224.1.0.23
PORT	49323
SET EXECUTE	

Item	Setting value	Setting details
<b>MAIN VIDEO TX</b>		
This is the setting for the main line output video.		
▶IP ADDR	(Factory setting: 224.1.0.5)	Sets the IP address for MAIN VIDEO TX.
▶PORT	01024 to 65535 (Factory setting: 49305) (Setting 10670 is prohibited.)	Sets the PORT for MAIN VIDEO TX.
<b>MONITOR VIDEO TX</b>		
This is the setting for the monitor output video.		
▶IP ADDR	(Factory setting: 224.1.0.6)	Sets the IP address for MONITOR VIDEO TX.
▶PORT	01024 to 65535 (Factory setting: 49306) (Setting 10670 is prohibited.)	Sets the PORT for MONITOR VIDEO TX.
<b>HD TRUNK TX</b>		
This is the setting for the HD TRUNK TX.		
▶IP ADDR	(Factory setting: 224.1.0.20)	Sets the IP address for HD TRUNK TX.
▶PORT	01024 to 65535 (Factory setting: 49320) (Setting 10670 is prohibited.)	Sets the PORT for HD TRUNK TX.
<b>MIC1 AUDIO TX</b>		
This is the setting for the MIC1 output.		
▶IP ADDR	(Factory setting: 224.1.0.7)	Sets the IP address for MIC1 AUDIO TX.
▶PORT	01024 to 65535 (Factory setting: 49307) (Setting 10670 is prohibited.)	Sets the PORT for MIC1 AUDIO TX.
<b>MIC2 AUDIO TX</b>		
This is the setting for the MIC2 output.		
▶IP ADDR	(Factory setting: 224.1.0.21)	Sets the IP address for MIC2 AUDIO TX.
▶PORT	01024 to 65535 (Factory setting: 49321) (Setting 10670 is prohibited.)	Sets the PORT for MIC2 AUDIO TX.
<b>INCOM1 AUDIO TX</b>		
This is the setting for the INCOM1 output.		
▶IP ADDR	(Factory setting: 224.1.0.22)	Sets the IP address for INCOM1 AUDIO TX.
▶PORT	01024 to 65535 (Factory setting: 49322) (Setting 10670 is prohibited.)	Sets the PORT for INCOM1 AUDIO TX.
<b>INCOM2 AUDIO TX</b>		
This is the setting for the INCOM2 output.		
▶IP ADDR	(Factory setting: 224.1.0.23)	Sets the IP address for INCOM2 AUDIO TX.
▶PORT	01024 to 65535 (Factory setting: 49323) (Setting 10670 is prohibited.)	Sets the PORT for INCOM2 AUDIO TX.
<b>SET EXECUTE</b>	-	When you press the [SELECT] button, [NETWORK(SCD TX) SET EXECUTE NO/YES] appears. Select [YES] to apply the configured [NETWORK(SFP+ SCD TX)] information to the unit. If this operation is not performed, the changed [NETWORK(SFP+ SCD TX)] settings will not be applied. In addition, if you exit the menu without performing this operation, the settings will return to their original values.

**NETWORK(SFP+ SCD RX)**

This is the selection screen for the NETWORK(SFP+ SCD RX) menu.

```

->> NETWORK(SFP+ SCD RX) 1/3

RET VIDEO RX
MCAST ADDR      224.1.0.8
SOURCE ADDR     0.0.0.0
PORT            49308
HD PROMPTER RX
MCAST ADDR      224.1.0.24
SOURCE ADDR     0.0.0.0
PORT            49324

SET EXECUTE
  
```

```

->> NETWORK(SFP+ SCD RX) 2/3

PGM1 AUDIO RX
MCAST ADDR      224.1.0.26
SOURCE ADDR     0.0.0.0
PORT            49326
PGM2 AUDIO RX
MCAST ADDR      224.1.0.27
SOURCE ADDR     0.0.0.0
PORT            49327

SET EXECUTE
  
```

```

->> NETWORK(SFP+ SCD RX) 3/3

INCOM1 AUDIO RX
MCAST ADDR      224.1.0.28
SOURCE ADDR     0.0.0.0
PORT            49328
INCOM2 AUDIO RX
MCAST ADDR      224.1.0.29
SOURCE ADDR     0.0.0.0
PORT            49329

SET EXECUTE
  
```

Item	Setting value	Setting details
<b>RET VIDEO RX</b>		This is the setting for the return video input.
▶MCAST ADDR	(Factory setting: 224.1.0.8)	Sets the IP address for RET VIDEO RX.
▶SOURCE ADDR	(Factory setting: 0.0.0.0)	Set to 0.0.0.0 if no limitations on multicast source are to be implemented. If you want to establish a source address, set the relevant address.
▶PORT	01024 to 65535 (Factory setting: 49308) (Setting 10670 is prohibited.)	Sets the PORT for RET VIDEO RX.
<b>HD PROMPTER RX</b>		This is the setting for the HD PROMPTER input.
▶MCAST ADDR	(Factory setting: 224.1.0.24)	Sets the IP address for HD PROMPTER RX.
▶SOURCE ADDR	(Factory setting: 0.0.0.0)	Set to 0.0.0.0 if no limitations on multicast source are to be implemented. If you want to establish a source address, set the relevant address.
▶PORT	01024 to 65535 (Factory setting: 49324) (Setting 10670 is prohibited.)	Sets the PORT for HD PROMPTER RX.
<b>SET EXECUTE</b>	-	When you press the [SELECT] button, [NETWORK(SCD RX) SET EXECUTE NO/YES] appears. Select [YES] to apply the configured [NETWORK(SFP+ SCD RX)] information to the unit. If this operation is not performed, the changed [NETWORK(SFP+ SCD RX)] settings will not be applied. In addition, if you exit the menu without performing this operation, the settings will return to their original values.

Item	Setting value	Setting details
<b>PGM1 AUDIO RX</b>		This is the setting for the PGM1 input.
▶MCAST ADDR	(Factory setting: 224.1.0.26)	Sets the IP address for PGM1 AUDIO RX.
▶SOURCE ADDR	(Factory setting: 0.0.0.0)	Set to 0.0.0.0 if no limitations on multicast source are to be implemented. If you want to establish a source address, set the relevant address.
▶PORT	01024 to 65535 (Factory setting: 49326) (Setting 10670 is prohibited.)	Sets the PORT for PGM1 AUDIO RX.
<b>PGM2 AUDIO RX</b>		This is the setting for the PGM2 input.
▶MCAST ADDR	(Factory setting: 224.1.0.27)	Sets the IP address for PGM2 AUDIO RX.
▶SOURCE ADDR	(Factory setting: 0.0.0.0)	Set to 0.0.0.0 if no limitations on multicast source are to be implemented. If you want to establish a source address, set the relevant address.
▶PORT	01024 to 65535 (Factory setting: 49327) (Setting 10670 is prohibited.)	Sets the PORT for PGM2 AUDIO RX.
<b>SET EXECUTE</b>	-	When you press the [SELECT] button, [NETWORK(SCD RX) SET EXECUTE NO/YES] appears. Select [YES] to apply the configured [NETWORK(SFP+ SCD RX)] information to the unit. If this operation is not performed, the changed [NETWORK(SFP+ SCD RX)] settings will not be applied. In addition, if you exit the menu without performing this operation, the settings will return to their original values.
<b>INCOM1 AUDIO RX</b>		This is the setting for the INCOM1 input.
▶MCAST ADDR	(Factory setting: 224.1.0.28)	Sets the IP address for INCOM1 AUDIO RX.
▶SOURCE ADDR	(Factory setting: 0.0.0.0)	Set to 0.0.0.0 if no limitations on multicast source are to be implemented. If you want to establish a source address, set the relevant address.
▶PORT	01024 to 65535 (Factory setting: 49328) (Setting 10670 is prohibited.)	Sets the PORT for INCOM1 AUDIO RX.
<b>INCOM2 AUDIO RX</b>		This is the setting for the INCOM2 input.
▶MCAST ADDR	(Factory setting: 224.1.0.29)	Sets the IP address for INCOM2 AUDIO RX.
▶SOURCE ADDR	(Factory setting: 0.0.0.0)	Set to 0.0.0.0 if no limitations on multicast source are to be implemented. If you want to establish a source address, set the relevant address.
▶PORT	01024 to 65535 (Factory setting: 49329) (Setting 10670 is prohibited.)	Sets the PORT for INCOM2 AUDIO RX.
<b>SET EXECUTE</b>	-	When you press the [SELECT] button, [NETWORK(SCD RX) SET EXECUTE NO/YES] appears. Select [YES] to apply the configured [NETWORK(SFP+ SCD RX)] information to the unit. If this operation is not performed, the changed [NETWORK(SFP+ SCD RX)] settings will not be applied. In addition, if you exit the menu without performing this operation, the settings will return to their original values.

**NETWORK(1GbE)**

This is the selection screen for the NETWORK(1GbE) menu.

```

->> NETWORK(1GbE) 1/2

DHCP                OFF
IP ADDR             192.168.0.52
PORT                49330

SUBNETMASK          255.255.255.0
DEFAULT GATEWAY     192.168.0.1
MAC ADDR            FF-FF-FF-FF-FF-FF

SET EXECUTE
  
```

```

->> NETWORK(1GbE) 2/2

DNS                MANUAL
PRIMARY            0.0.0.0
SECONDARY          0.0.0.0
DOMAIN
  
```

Item	Setting value	Setting details
<b>DHCP</b>	OFF, ON (Factory setting: OFF)	Enables/disables DHCP.
<b>IP ADDR</b>	(Factory setting: 192.168.0.52)	Sets the IP address for 1GbE (LAN2).
<b>PORT</b>	(Factory setting: 49330)	Sets the PORT for 1GbE (LAN2).
<b>SUBNETMASK</b>	(Factory setting: 255.255.255.0)	Sets the subnet mask.
<b>DEFAULT GATEWAY</b>	(Factory setting: 192.168.0.1)	Sets the default gateway.
<b>MAC ADDR</b>	Display only	Displays the MAC address.
<b>SET EXECUTE</b>	-	When you press the [SELECT] button, [NETWORK(1GbE) SET EXECUTE NO/YES] appears. Select [YES] to apply the configured [NETWORK(1GbE)] information to the unit. If this operation is not performed, the changed [NETWORK(1GbE)] settings will not be applied. In addition, if you exit the menu without performing this operation, the settings will return to their original values.
<b>DNS</b>	MANUAL, AUTO (Factory setting: MANUAL)	Sets whether the DNS server address is to be acquired automatically (AUTO), or to be input manually (MANUAL). <ul style="list-style-type: none"> <li>This can be set only from the web screen (AK-NP600).</li> </ul>
▶PRIMARY		<ul style="list-style-type: none"> <li>This can be set only from the web screen (AK-NP600).</li> </ul>
▶SECONDARY		<ul style="list-style-type: none"> <li>This can be set only from the web screen (AK-NP600).</li> </ul>
▶DOMAIN		The value allocated by the DHCP server is displayed. (Up to 253 characters, display up to 128 characters) <ul style="list-style-type: none"> <li>This can be set only from the web screen (AK-NP600).</li> </ul>

**NETWORK(TALLY IN)**

This is the selection screen for the NETWORK(TALLY IN) menu.

```

->> NETWORK(TALLY IN)

INDEX NO:          1
PORT:             62000

SET EXECUTE
  
```

Item	Setting value	Setting details
<b>INDEX NO</b>	1 to 65534 (Factory setting: 1)	Sets the INDEX NO set by devices that output TALLY.
<b>PORT</b>	60000 to 65535 (Factory setting: 62000)	Sets the PORT for TALLY IN.
<b>SET EXECUTE</b>	-	When you press the [SELECT] button, [NETWORK(TALLY IN) SET EXECUTE NO/YES] appears. Select [YES] to apply the configured [NETWORK(TALLY IN)] information to the unit. If this operation is not performed, the changed [NETWORK(TALLY IN)] settings will not be applied. In addition, if you exit the menu without performing this operation, the settings will return to their original values.

 **NOTE**

- The IP address of TALLY IN becomes the setting of the connected IP network.

Ex.: When input from SFP+ primary

The main IP ADDR of NETWORK(SFP+ PRM) is enabled.



**NETWORK(PTP)**

This is the selection screen for the NETWORK(PTP) menu.

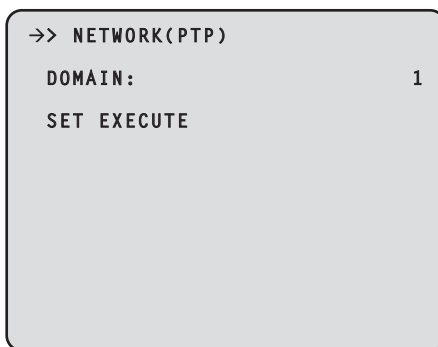

Item	Setting value	Setting details
<b>DOMAIN</b>	0 to 127 (Factory setting: 127)	Sets the DOMAIN number.
<b>SET EXECUTE</b>	-	When you press the [SELECT] button, [NETWORK(PTP) SET EXECUTE NO/YES] appears. Select [YES] to apply the configured [NETWORK(PTP)] information to the unit. If this operation is not performed, the changed [NETWORK(PTP)] settings will not be applied. In addition, if you exit the menu without performing this operation, the settings will return to their original values.

**NETWORK(NMOS)**

This is the selection screen for the NETWORK(NMOS) menu.

```

->> NETWORK(NMOS)

NMOS CONTROL:          ON
STATUS:                UNREGISTERED
PORT(IS-04):          50040
PORT(IS-05):          50050
RDS IP ADDR:          ---
RDS PORT:             ---
LABEL SETTING:        AUTO
LABEL PREFIX:         UCU600_0001
DISCOVERY:            uniDNS
SET EXECUTE

```

Item	Setting value	Setting details
<b>NMOS CONTROL</b>	ON, OFF (Factory setting: ON)	Enables/disables the NMOS function.
<b>STATUS</b>	--- (Factory setting: UNREGISTERED,)	Displays the NMOS operation status, such as RDS connection status.  (Display only. Settings cannot be modified.)
<b>PORT(IS-04)</b>	1024 to 65535 (Factory setting: 50040)	Sets the port number on the camera for IS-04 Node API.
<b>PORT(IS-05)</b>	1024 to 65535 (Factory setting: 50050)	Sets the port number on the camera for IS-05 Connection API.
<b>RDS IP ADDR</b>	0.0.0.0 to 255.255.255.255	Displays the discovered IP address.
<b>RDS PORT</b>	1 to 65535	Displays the port number automatically discovered.
<b>LABEL SETTING</b>	AUTO MANUAL	AUTO:  The LABEL PREFIX cannot be changed.  It is fixed to UCU600_**** ("*****" is the last four digits of the MAC ADDR).  MANUAL: Text can be set in LABEL PREFIX.
<b>LABEL PREFIX</b>	Maximum 16 characters (alphanumeric characters, spaces, ! # % ( ) + , - . / = [ ] _) (Factory setting: UCU600_**** ("*****" is the last four digits of the MAC ADDR))	Sets the prefix appended which is shared with NMOS resource names on this unit.
<b>DISCOVERY</b>	uniDNS, mDNS (Factory setting: uniDNS)	Sets the method for registry discovery.
<b>SET EXECUTE</b>	-	When the [SELECT] button is pressed, [NETWORK(NMOS) SET EXECUTE NO/YES] is displayed. The [NETWORK(NMOS)] information you set is updated in the unit when you select [YES].  The modified [NETWORK(NMOS)] settings are not updated if you do not perform this procedure. Also, if you close the menu without performing this procedure, the modified content returns to the original settings.

## VERSION

This is the selection screen for the VERSION menu.

```

->*** VERSION ***

VERSION      01.00-000-00.00
SOFTWARE     01.00-000-00.00
NETWORK      01.00-000-00.00
UHD FPGA     01.00-000-00.00
HS FPGA      01.00-000-00.00
RETURN FPGA1 01.00-000-00.00
RETURN FPGA2 01.00-000-00.00
MAIN FPGA    01.00-000-00.00
INCOM FPGA   01.00-000-00.00
USC FPGA     01.00-000-00.00
  
```

\_\_\_ indicates factory default settings.

Item	Setting value	Setting details
<b>VERSION</b>	Display only	Displays the version of the entire unit.
<b>SOFTWARE</b>	Display only	Displays the version of the application.
<b>NETWORK</b>	Display only	Display the version of the network software.
<b>UHD FPGA</b>	Display only	Displays the FPGA (UHD) version.
<b>HS FPGA</b>	Display only	Displays the FPGA (HS) version.
<b>RETURN FPGA1</b>	Display only	Displays the FPGA (RETURN1) version.
<b>RETURN FPGA2</b>	Display only	Displays the FPGA (RETURN2) version.
<b>MAIN FPGA</b>	Display only	Displays the FPGA (MAIN) version.
<b>INCOM FPGA</b>	Display only	Displays the FPGA (INCOM) version.
<b>USC FPGA</b>	Display only	Displays the FPGA (USC) version.

## PM VIEW SETTING(1/2)

This is the selection screen for the PM VIEW SETTING(1/2) menu.

->*** PM VIEW SETTING(1/2) ***	
CAMERA NO	ON
SYSTEM FORMAT	ON
FORMAT MODE	ON
SCENE FILE No	ON
SHUTTER	ON
ND/CC FILTER	ON
EXTENDER INFO	ON
IRIS	ON
IRIS LEVEL	ON
IRIS SCALE	FULL
COLOR TEMP VALUE	ON
IRIS MEMORY	ON

\_\_\_ indicates factory default settings.

Item	Setting value	Setting details
<b>CAMERA NO</b>	ON OFF	Set display of the camera number on the picture monitor to ON or OFF.
<b>SYSTEM FORMAT</b>	ON OFF	Set display of the system format on the picture monitor to ON or OFF.
<b>FORMAT MODE</b>	ON OFF	Set display of the format mode on the picture monitor to ON or OFF.
<b>SCENE FILE No</b>	ON OFF	Set display of the scene file number on the picture monitor to ON or OFF.
<b>SHUTTER</b>	ON OFF	Set display of the shutter value on the picture monitor to ON or OFF.
<b>ND/CC FILTER</b>	ON OFF	Set display of the ND/CC filter name to the picture monitor to ON or OFF.
<b>EXTENDER INFO</b>	ON OFF	Set display of extender information (extender and digital extender) on the picture monitor to ON or OFF.
<b>IRIS</b>	ON OFF	Set display of the IRIS F value on the picture monitor to ON or OFF.
<b>IRIS LEVEL</b>	ON OFF	Set display of the IRIS level bar on the picture monitor to ON or OFF. <ul style="list-style-type: none"> <li>When [OFF] is set, the IRIS menu is not displayed on the picture monitor.</li> </ul>
<b>IRIS SCALE</b>	FULL 2STOP	Set the IRIS display range of the status display screen.
<b>COLOR TEMP VALUE</b>	ON OFF	Set display of the color temperature on the picture monitor to ON or OFF.
<b>IRIS MEMORY</b>	ON OFF	Set display of the IRIS value stored in camera memory on the picture monitor to ON or OFF.

## PM VIEW SETTING(2/2)

This is the selection screen for the PM VIEW SETTING(2/2) menu.

```

->*** PM VIEW SETTING(2/2) ***
TALLY INFO          ON
F.DROP              OFF
ZOOM POSITION        ON
FOCUS POSITION       ON
OPT_CAM             ON
OPT_CCU             ON
COLORIMETRY        ON
  
```

\_\_\_ indicates factory default settings.

Item	Setting value	Setting details
TALLY INFO	<u>ON</u> OFF	Set display of the tally information on the picture monitor to ON or OFF.
F.DROP	ON <u>OFF</u>	Shows/hides the F.DROP that is notified by the camera, on the picture monitor.
ZOOM POSITION	<u>ON</u> OFF	Set display of the zoom position information, which is notified by the camera, on the picture monitor to ON or OFF.
FOCUS POSITION	<u>ON</u> OFF	Set display of the focus position information, which is notified by the camera, on the picture monitor to ON or OFF.
OPT_CAM	<u>ON</u> OFF	Set display of the optical signal level (camera side) on the picture monitor to ON or OFF.
OPT_CCU	ON <u>OFF</u>	Set display of the optical signal level (CCU side) on the picture monitor to ON or OFF.
COLORIMETRY	<u>ON</u> OFF	Set display of COLORIMETRY (Y/C conversion coefficient), which is notified by the camera, on the picture monitor to ON or OFF.

## PM OPERATION STATUS

This is the selection screen for the PM OPERATION STATUS menu.

->*** PM OPERATION STATUS ***	
STATUS DISPLAY TIME	4
MANUAL OPERATION STATUS	
MASTER GAIN	ON
SHUTTER	ON
LENS EXTENDER	ON
FILTER	ON
SCENE FILE	ON
REF LOAD	ON
AUTO OPERATION STATUS	ON

\_\_\_ indicates factory default settings.

Item	Setting value	Setting details
<b>STATUS DISPLAY TIME</b>	0 2 4	Set display of the status display time on the picture monitor to ON or OFF.
<b>MANUAL OPERATION STATUS</b>		
▶ MASTER GAIN	ON OFF	Set display of picture monitor operation display item (MASTER GAIN) ON/OFF.
▶ SHUTTER	ON OFF	Set display of the picture monitor operation display item (SHUTTER) to ON or OFF.
▶ LENS EXTENDER	ON OFF	Set display of the picture monitor operation display item (LENS EXT) to ON or OFF.
▶ FILTER	ON OFF	Set display of picture monitor operation display item (FILTER) to ON or OFF.
▶ SCENE FILE	ON OFF	Set display of picture monitor operation display item (SCENE FILE) to ON or OFF.
▶ REF LOAD	ON OFF	Set display of picture monitor operation display item (REF LOAD) ON/OFF.
<b>AUTO OPERATION STATUS</b>	ON OFF	Set display of picture monitor operation display item (AUTO) to ON or OFF.

## SYSTEM

This is the selection screen for the SYSTEM menu.

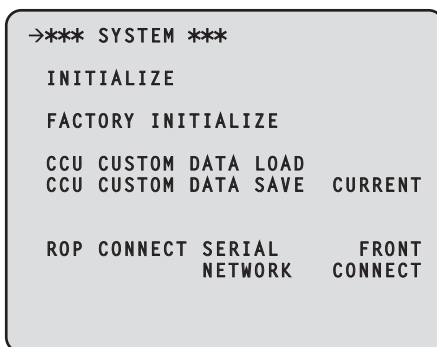

\_\_\_\_\_ indicates factory default settings.

Item	Setting value	Setting details
<b>INITIALIZE</b>	-	Return the menu items to the factory default values. ➔ "Initialize the Unit Settings (INITIALIZE)" (see page 116)
<b>FACTORY INITIALIZE</b>	-	Return the unit's settings to the factory default values. When you place the cursor on [FACTORY INITIALIZE] and press the [SELECT] dial, [FACTORY INITIALIZE? NO/YES] appears. Select [YES] to start initialization. <ul style="list-style-type: none"> <li>Controls from the camera, ROP, or MSU cannot be performed during initialization.</li> </ul>
<b>CCU CUSTOM DATA LOAD</b>	-----	Call the CCU management data stored in the CCU.
<b>CCU CUSTOM DATA SAVE</b>	CURRENT FACTORY CANCEL	Store the setting data managed by the CCU inside the CCU. The items that are stored are the same as the items set with [FACTORY INITIALIZE]. <b>CURRENT</b> Saves the values currently set for the CCU. <b>FACTORY</b> Saves the values set with [FACTORY INITIALIZE].
<b>ROP CONNECT SERIAL</b>	FRONT REAR -----	Displays the status of ROP connection (serial connection) to the unit. <b>FRONT</b> Connection is to the front panel [ROP] connector. <b>REAR</b> Connection is to the rear panel [ROP] connector. ----- No serial connection.
<b>ROP CONNECT NETWORK</b>	CONNECT -----	Displays the status of ROP connection (IP connection) to the unit. <b>CONNECT</b> Connection is by IP connection. ----- No IP connection.

## Initialize the Unit Settings (INITIALIZE)

### Initialization Procedure

1. Turn the [SELECT] dial to move the cursor to [INITIALIZE], and then press the [SELECT] dial.
2. Turn the [SELECT] dial to select [YES?], and then press the [SELECT] dial.

Initialization begins.

### Data Initialized

✓: Initialized ×: Not initialized

CCU menu	INITIALIZE	FACTORY INITIALIZE
OPERATION	✓	✓
UHD SETTING	✓	✓
AUDIO	✓	✓
<b>MAINTENANCE</b>		
▶ START UP	✓ (excluding [CONNECT MODE])	✓
▶ SETUP	✓ (excluding [ROP SW])	✓
▶ AUX	✓	✓
▶ ANALOG GAIN	✓	✓
▶ ND/CC NAME	✓	✓
▶ NETWORK	×	✓
▶ VERSION	×	×
▶ PM VIEW SETTING	✓	✓
▶ PM OPERATION STATUS	✓	✓
▶ SYSTEM	×	×
▶ SD CARD	×	×



## SD CARD

This is the selection screen for the SD CARD menu.

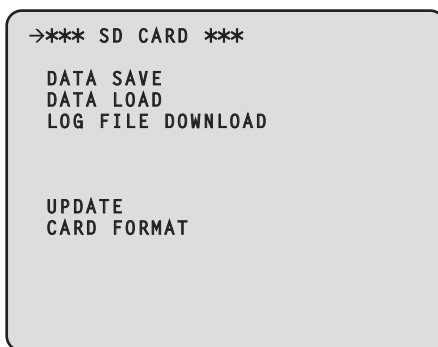

\_\_\_ indicates factory default settings.

Item	Setting value	Setting details
<b>DATA SAVE</b>	-	Save the unit's setting information to memory card. When you select this, the execution confirmation screen (NO?, YES?) appears.
<b>DATA LOAD</b>	-	Load the unit's setting information saved in memory card to this unit. When you select this, the execution confirmation screen (NO?, YES?) appears.
<b>LOG FILE DOWNLOAD</b>	-	Save CCU (this unit) log information to memory card. When you select this, the execution confirmation screen (NO?, YES?) appears.
<b>UPDATE</b>	-	Upgrade the unit's software or programs (FPGA) with files saved to the memory card. When you select this, the execution confirmation screen (NO?, YES?) appears.
<b>CARD FORMAT</b>	-	Initialize the memory card. When you select this, the execution confirmation screen (NO?, YES?) appears. <ul style="list-style-type: none"> <li>• Initialization may take about 5 minutes.</li> <li>• Be sure to execute initialization after confirming the data because any data that is deleted by the initialization cannot be recovered.</li> </ul>

### Data Stored/Loaded

The following data is stored/loaded.

- Items in the [OPERATION] menu
- Items in the [MAINTENANCE] menu  
(The [NETWORK] menu, [VERSION] menu, [SYSTEM] menu, and [SD CARD] menu are excluded.)
- Items in the [SYSTEM] menu

### SD Card Error Messages

When an error occurs during processing of SD card menu items, the following messages are displayed.

Messages	Content and remedy
LOAD ERROR	Unable to read from the memory card. <ul style="list-style-type: none"> <li>• Data written with other than this unit cannot be read.</li> </ul>
WRITE ERROR	Unable to write to the memory card. <ul style="list-style-type: none"> <li>• The memory card is likely to be defective. Replace the memory card.</li> </ul>

**Saving and loading reference files and scene files**

When reference files and scene files are saved or loaded from the ROP, the following data applies.

Menu	Saved / loaded data	
	Reference file	Scene file
AUDIO	MIC OUT CCU INTERCOM TALK CCU INTERCOM RECEIVE STANDBY INTERCOM COMMUNICATION INTERCOM1 INTERCOM2 PGM	-
MAINTENANCE	ND/CC NAME	-

# Web Screen

## Network settings

### Software

Download Easy IP Setup Software (EasyIPSetup.exe) from the following website and then install them. [Windows]

- **Download URL**  
<https://pro-av.panasonic.net/en/>

### Easy IP Setup Software (EasyIPSetup.exe)

This software sets the unit's network settings.

➔ "Using Easy IP Setup Software to set the unit's settings" (see page 119)

### Plug-in viewer software installer (nwcV4SSetup.exe)

Install the plug-in software (Network Camera View 4S) required to view IP images from the unit in a web browser.

➔ "Installing the plug-in viewer software" (see page 121)

## Using Easy IP Setup Software to set the unit's settings

The settings related to the unit's network can be set using the supplied Easy IP Setup Software.

To set the settings for a multiple number of units, the settings must be selected for each camera involved.

If the settings cannot be set using Easy IP Setup Software, set the settings for the unit and personal computer individually in [MAINTENANCE] > [NETWORK] of the CCU menu.

➔ "NETWORK(1/2)" (see page 98)

### NOTE

- If, after the network settings have been set, another device on the same network has the same IP address, the network operations will not be performed properly. Set the IP address in such a way that it does not duplicate an existing IP address.
- Do not set network settings from a multiple number of Easy IP Setup Software programs at the same time for a single camera.
- Easy IP Setup Software cannot be used from a different subnet via a router.
- It is not possible to display the unit or set its settings using an older version of Easy IP Setup Software (Ver.4.25 or earlier).

### Setting Procedure

1. Start the Easy IP Setup Software.
2. Click the [Search] button.

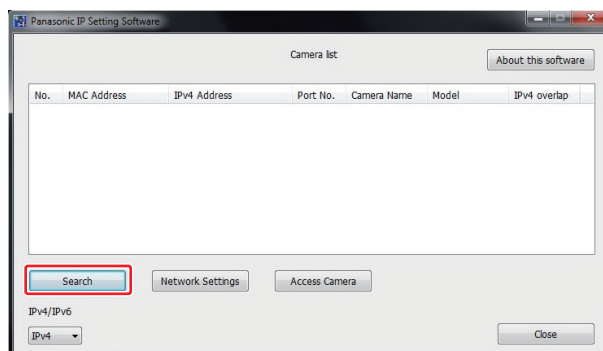

3. Click the MAC address/IPv4 address of the camera to be set, and click the [Network Settings] button.

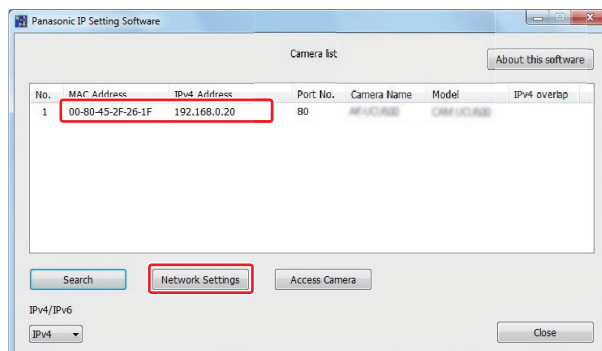

- If the same IP address is used for any additional cameras, the numbers of the additional cameras will be displayed in the [IPv4 overlap] column of the cameras concerned.
- When the [Access Camera] button is clicked, the Live screen of the selected camera is displayed.

4. Input the network items, and click the [Save] button.

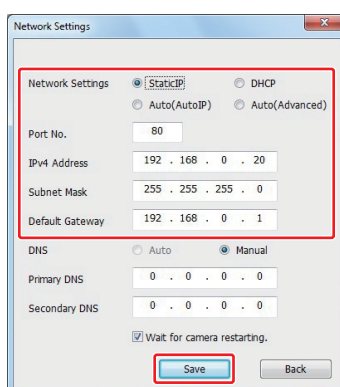

- The connection mode of the unit supports only [Static IP]. Do not set, for example, DHCP because it is not supported.
- After the [Save] button is clicked, it takes about 2 minutes for the settings in the unit to be completed. If this unit is turned off or the LAN cable is disconnected before the settings are completed, the settings will be invalidated. In this case, repeat the steps to set the settings.

**NOTE**

- The unit does not support IPv6.
- When a firewall (including software) has been introduced, enable access to all the UDP ports.
- The unit does not support DNS.

## Installing the plug-in viewer software

To view IP images from the unit on a web browser, the "Network Camera View 4S" plug-in viewer software (ActiveX®) must be installed. The plug-in viewer software can be installed directly from the unit.

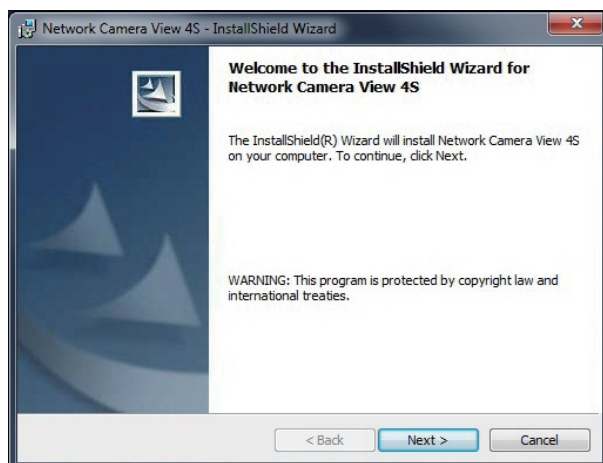

- [Automatic installation of viewer software] is set to [On] at the time of purchase, allowing you to install directly from the unit. If a message appears in the web browser's information bar, see "Troubleshooting".  
➔ "Web Screen" (see page 175)
- When you display the [Live] screen on the personal computer for the first time, the installation screen for the plug-in viewer software (ActiveX) appears. Follow the instructions on the screen to perform installation.
- If the plug-in viewer software (ActiveX) installation screen continues to appear when switching screens, even after it is installed, restart the personal computer.
- To uninstall the plug-in viewer software, select [Control Panel] - [Programs] - [Uninstall a program] in Windows, and remove "Network Camera View 4S".
- A license is required for the plug-in viewer software for each personal computer on which it is installed. You can view the number of times the plug-in viewer software was automatically installed in the [Maintenance] screen. For details on licenses, consult your dealer.  
➔ "[Maintenance] screen" (see page 145)

## Displaying the web screen

With a personal computer connected to the unit, it is possible to view the camera's IP videos or select various settings from the web browser.

Use a LAN crossover cable when connecting a personal computer directly to the unit's LAN connector for IP control. Use a LAN straight cable when connecting through a switching hub or other device.

### Notice regarding the Web screen

#### IP address and subnet mask

Select an IP address for the personal computer within the private address range while ensuring that it is different from the address of the unit. Set the subnet mask to the same address as the unit.

If you need to change the IP address and subnet mask, be sure to ask your dealer to make these changes for you.

- **Unit's IP address and subnet mask (factory settings)**

<b>IP address</b>	192.168.0.20
<b>Subnet mask</b>	255.255.255.0
<b>Range of private addresses</b>	192.168.0.0 to 192.168.0.255

#### Personal computer environment required to display the Web screen

For details on the personal computer environment required to display the Web screen, refer to following page.

➔ "Personal computer requirements" (see page 11)

- Some functions on the web setting screen can be used only from a personal computer which is running Windows. (They cannot be used from a personal computer which is running OS X (Mac).)  
Functions which can be used by Windows only are indicated using [Windows].
- The "Network Camera View 4S" plug-in viewer software must have already been installed in order to display the unit's IP videos using a personal computer which is running Windows. (This is not required for a personal computer which is running OS X (Mac).)  
➔ "Installing the plug-in viewer software" (see page 121)

### Displaying the web screen using a personal computer

The procedure is explained here using Windows (Internet Explorer) screens, but it is the same when using the Mac (Safari) screens. (There may be differences in some parts of the screen displays.)

#### 1. Start the web browser of the personal computer.

Use one of the web browsers below depending on the operating system installed in the personal computer.

Installed OS	Web browser
Windows	Internet Explorer
OS X (Mac)	Safari

#### 2. Enter the IP address you configured on the Easy IP Setup Software in the address bar of the web browser.

- Example of input  
http://registered URL  
http://192.168.0.20



- If the HTTP port number has been changed from 80, enter [http://<camera IP address>:<port number>] in the address bar.  
Ex.: When the port number is set to 8080 :  
http://192.168.0.20:8080
- When this unit is in a local network, set a proxy server from the web browser ([Tools] - [Internet Options] in the menu bar) to ensure that a proxy server is not used for a local address.

### 3. Press the [Enter] key.

The web screen appears.

The [Live] screen is displayed initially. You can switch to the [Setup] screen when necessary.

➡ “Switching the [Live] screen or [Setup] screen” (see page 124)



#### NOTE

- If the personal computer does not have the plug-in viewer software already installed, an installation confirmation message is displayed before the [Live] screen is displayed. In a case like this, follow the on-screen instructions to install the software. [Windows]
  - ➡ “Installing the plug-in viewer software” (see page 121)
- When “User auth.” (see page 139) is set to [On], the user name and password input screen is displayed before the [Live] screen appears.
 

The default settings for the user name and password are as follows.

User name: admin  
Password: 12345
- While the initial settings remain used for the user name and password, a message prompting the user to change the user name and password is displayed after authorization. In order to ensure security, the password for the user name of “admin” must be changed without fail. It is also recommended that the password be changed at regular intervals.
- When an attempt is made to display multiple H.264 images on one personal computer, IP videos may not be displayed depending on the performance of the personal computer concerned. [Windows]
- When an item which is underlined on the screen is clicked, a separate window opens, and an input example is displayed.
- Up to 14 users (consisting of users receiving H.264 images and users receiving JPEG images) can access the unit at the same time. However, depending on the settings for the [Bandwidth control (bit rate)] and [Max bit rate (per client)], the number of users who can access the unit may be limited to less than 14. A message indicating the access limit will appear if the number of users exceeds 14. When [Transmission type] is set to [Multicast port] for [H.264], the second and subsequent users receiving H.264 images will not be counted toward the total access count.
- When “H.264 transmission” (see page 134) is set to [On], H.264 images are displayed. When it is set to [Off], JPEG images will be displayed. JPEG images can be displayed even when [H.264 transmission] is set to [On]. In such cases, however, the maximum frame rate for JPEG images will be 5 fps. [Windows]
- The frame rate for JPEG images may be slower depending on the network environment, performance of your personal computer, subject of the video, and access volume.
 

**<Frame rate for JPEG images>**  
 When [H.264 transmission] is [On]: Maximum 5 fps  
 When [H.264 transmission] is [Off]: Maximum 30 fps

## Switching the [Live] screen or [Setup] screen

When the [Live] screen is displayed, click the [Setup] button.

For details on the [Setup] screen, see the following page.

➔ "[Setup] screen" (see page 129)

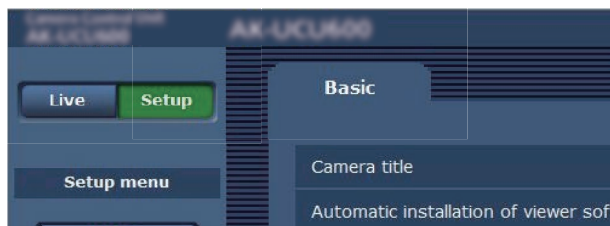

When the [Setup] screen is displayed, click the [Live] button.

For details on the [Live] screen, see the following page.

➔ "[Live] screen" (see page 125)

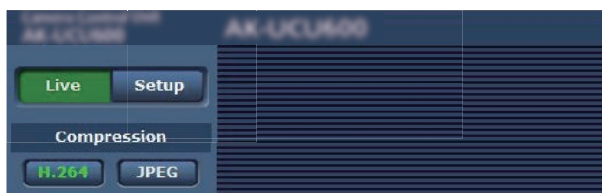



## [Live] screen

This screen allows you to display camera images on the personal computer.

- The items displayed on the screen will differ depending on whether the [H.264] or [JPEG] button is selected under [Compression].
- **H.264**

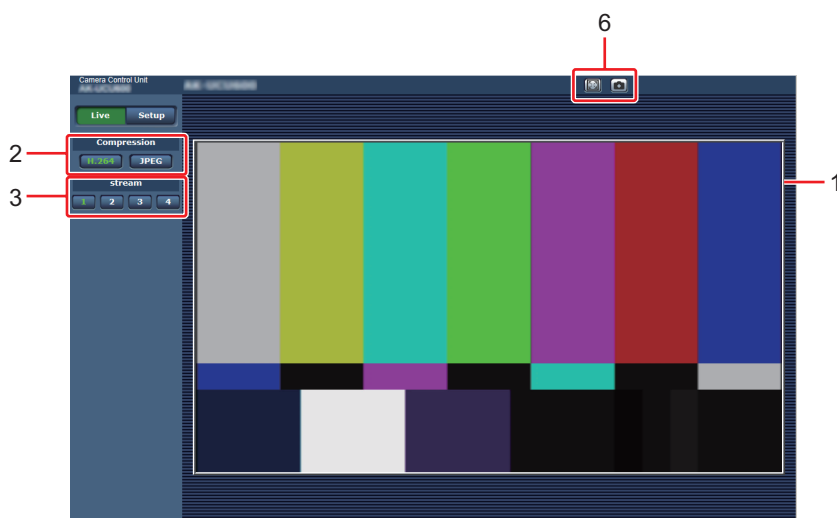

- **JPEG**

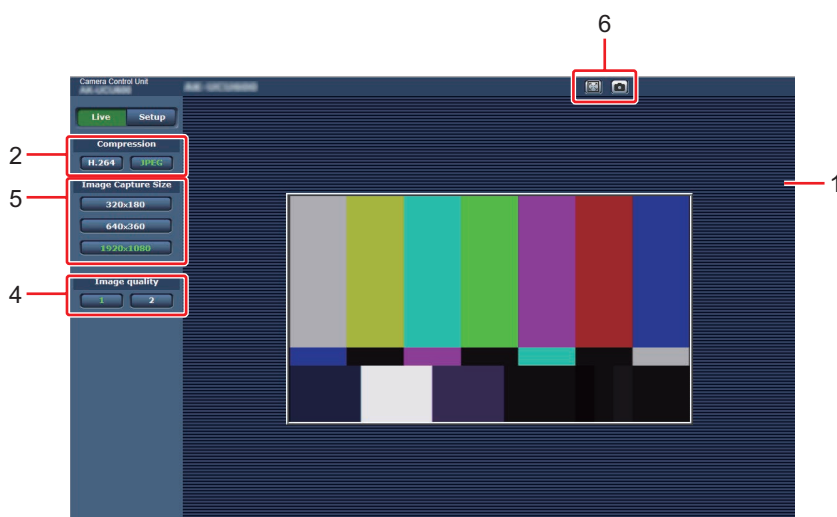

	Content	Details page
1	Main area (IP video display area)	➔ "Main area (IP video display area)" (see page 126)
2	Compression button	➔ "[Compression] button" (see page 126)
3	stream button	➔ "[stream] button" (see page 127)
4	Image quality button	➔ "[Image quality] button" (see page 127)
5	Image Capture Size button	➔ "[Image Capture Size] button" (see page 128)
6	Full-screen display button/SnapShot button [Windows]	➔ "Full-screen display button/SnapShot button" (see page 128)

## Parts and their functions ([Live] screen)

### Main area (IP video display area)

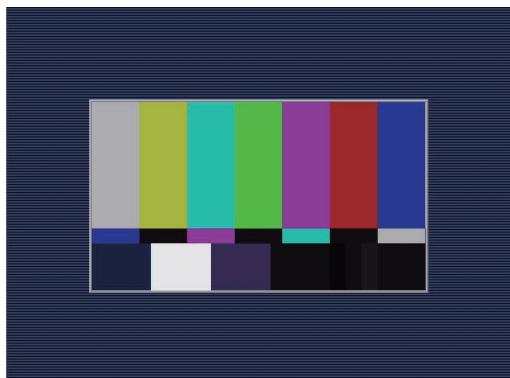

The IP video of the connected camera will be displayed.



Operating the mouse wheel inside the display area allows you to use the plug-in viewer software's digital zoom. [Windows]

- When the shooting scenes vary significantly, restrictions imposed by the graphics processing (GDI) of the operating system installed may give rise to a phenomenon called screen tearing (where parts of the picture are not displayed in synchronization) although this will depend on the personal computer used.
- On a personal computer running Windows, if [H.264 transmission] is set to [On], H.264 images and JPEG images can be displayed. When it is set to [Off], only JPEG images will appear. Furthermore, on a personal computer running OS X (Mac), only JPEG images will be displayed regardless of the [H.264 transmission] settings. (H.264 images will not appear.)  
➔ "H.264 transmission" (see page 134)
- When [H.264 transmission] is set to [On], the frame rate for JPEG images may drop, regardless of whether H.264 images are being transmitted.
- The frame rate for JPEG images may be reduced depending on the network environment, performance of the personal computer used, subjects and number of access users.
- Up to 14 users (consisting of users receiving H.264 images and users receiving JPEG images) can access the unit at the same time. However, depending on the settings for the [Bandwidth control (bit rate)] and [Max bit rate (per client)], the number of users who can access the unit may be limited to less than 14.
- If the maximum number of users who can access the unit has exceeded the upper limit, a message advising that the unit is being accessed by more users than the maximum number allowed is displayed. [Windows]
- IP video cannot be transmitted when [CCU MODE] is set to [2160/23PsF & over59i] or [1080/23PsF & over59i].

### [Compression] button

Switch between H.264 image display and JPEG image display.



1	 [H.264]	When selected, the text "H.264" on the button turns green, and H.264 images are displayed. [Windows] <ul style="list-style-type: none"> <li>• The [H.264] button is enabled when the [H.264 transmission] setting of [H.264 (1)] to [H.264 (4)] is set to [On] in the IP video settings. ➔ "H.264 (1) · H.264 (2) · H.264 (3) · H.264 (4)" (see page 134)</li> </ul>
2	 [JPEG]	When selected, the text "JPEG" on the button turns green, and JPEG images are displayed.





- In the following cases, the selection status of the [Compression] buttons will return to the setting configured in the [Video over IP] tab; [Initial display settings for "Live" page] - [Stream]. [Windows]
  - When returning from another screen
  - When the screen is updated

**[stream] button**

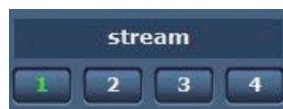
These buttons appear only when H.264 images are displayed. [Windows]

Images are displayed according to the setting configured with [H.264 (1)] / [H.264 (2)] / [H.264 (3)] / [H.264(4)].



1	 [1]	When selected, the text "1" on the button turns green, and the images in the main area appear according to the settings configured for [H.264(1)]. ➔ "H.264 (1) · H.264 (2) · H.264 (3) · H.264 (4)" (see page 134)
2	 [2]	When selected, the text "2" on the button turns green, and the images in the main area appear according to the settings configured for [H.264(2)]. ➔ "H.264 (1) · H.264 (2) · H.264 (3) · H.264 (4)" (see page 134)
3	 [3]	When selected, the text "3" on the button turns green, and the images in the main area appear according to the settings configured for [H.264(3)]. ➔ "H.264 (1) · H.264 (2) · H.264 (3) · H.264 (4)" (see page 134)
4	 [4]	When selected, the text "4" on the button turns green, and the images in the main area appear according to the settings configured for [H.264(4)]. ➔ "H.264 (1) · H.264 (2) · H.264 (3) · H.264 (4)" (see page 134)



- In the following cases, the selection status of the [stream] buttons will return to the setting configured in the [Video over IP] tab; [Initial display settings for "Live" page] - [Stream]. [Windows]
  - When returning from another screen
  - When the screen is updated
- If the H.264 image resolution is set to [1920x1080] or [1280x720], the image may be compressed depending on the size of the web browser window.

**[Image quality] button**

These buttons appear only when JPEG images are displayed.

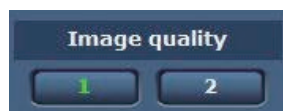
When selected, images appear according to the settings configured in the [Image quality(JPEG)] settings.



1	 [1]	When selected, images appear according to the settings configured for [Quality1] in the [Image quality(JPEG)] settings. ➔ "Image quality (JPEG)" (see page 132)
2	 [2]	When selected, images appear according to the settings configured for [Quality2] in the [Image quality(JPEG)] settings. ➔ "Image quality (JPEG)" (see page 132)



- In the following cases, the selection status of the [Image quality] button will return to the setting configured in the [Video over IP] tab; [Initial display settings for "Live" page] - [Image quality(JPEG)].
  - When returning from another screen
  - When the screen is updated

### [Image Capture Size] button

These buttons appear only when JPEG images are displayed.

They switch the size of images displayed in the main area.

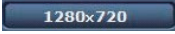

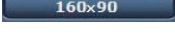
1	 [1920 x 1080]	When selected, the text on the [1920 × 1080] button turns green, and the images in the main area appear in 1920 × 1080 size.
2	 [1280 x 720]	When selected, the text on the [1280 × 720] button turns green, and the images in the main area appear in 1280 × 720 size.
3	 [640 x 360]	When selected, the text on the [640 × 360] button turns green, and the images in the main area appear in 640 × 360 size.
4	 [320 x 180]	When selected, the text on the [320 × 180] button turns green, and the images in the main area appear in 320 × 180 size.
5	 [160 x 90]	When selected, the text on the [160 × 90] button turns green, and the images in the main area appear in 160 × 90 size.



- The resolution selected with [JPEG(1)], [JPEG(2)], and [JPEG(3)] under [JPEG] in the [Video over IP] tab is displayed.
- If the resolution is set to [1920×1080] or [1280×720], the image may be compressed depending on the size of the web browser window.
- In the following cases, the selection status of the [Image Capture Size] buttons will return to the setting configured in the [Video over IP] tab; [Initial display settings for "Live" page] - [Stream].
  - When returning from another screen
  - When the screen is updated

### Full-screen display button/SnapShot button

Display images in full-screen mode. (Full-screen display button) [Windows]

Capture a snapshot. (Snapshot button)



1	<b>Full-screen display button</b> 	Display the image in full-screen mode. When the image displayed in the main area is compressed, clicking this once displays the image at the correct resolution in the main area. When the image is displayed at the correct resolution, the image is displayed in full-screen mode. To return to the Live screen, press the [Esc] key on the personal computer while the image is displayed in full-screen mode. The aspect ratio of the displayed image will be adjusted according to the monitor size.
2	<b>Snapshot button</b> 	Capture a snapshot (single still image), and display it in a separate window. A pop-up menu appears when you right-click the image, and you can select [Save] to save the image to the personal computer. You can also click [Print] to output from a printer.

### NOTE

- The following settings may be necessary.  
In the Internet Explorer menu bar, click [Tools] - [Internet Options] - [Security] tab, select [Trusted Sites], and then click [Sites]. Register the camera's address under [Websites] in the window that appears.
- Depending on the network environment, for example, if snapshot capture takes longer than a certain amount of time, the image may not appear.

## [Setup] screen

The settings for the unit are selected on this screen.

- The setting menu operations can be performed only by users whose [Access level] is [1. Administrator].

➔ "Access level" (see page 140)

### Logging into the [Setup] screen

#### 1. Click the [Setup] button.

➔ "Switching the [Live] screen or [Setup] screen" (see page 124)

The login screen appears.



#### 2. Enter the user name and password.

The default settings for the user name and password are as follows.

User name	admin
Password	12345

#### 3. Click the [OK] button.

Click [OK] again when the following screen appears.

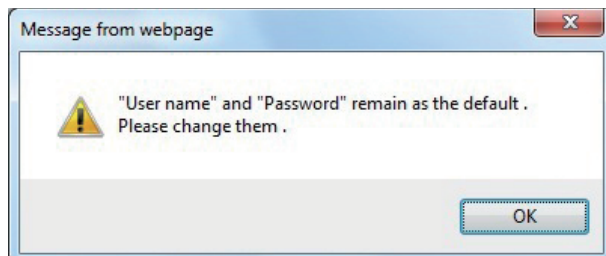

- While the initial settings remain used for the user name and password, a message prompting the user to change the user name and password is displayed after authorization. In order to ensure security, the password for the user name of "admin" must be changed without fail. It is also recommended that the password be changed at regular intervals.

## Parts and their functions ([Setup] screen)

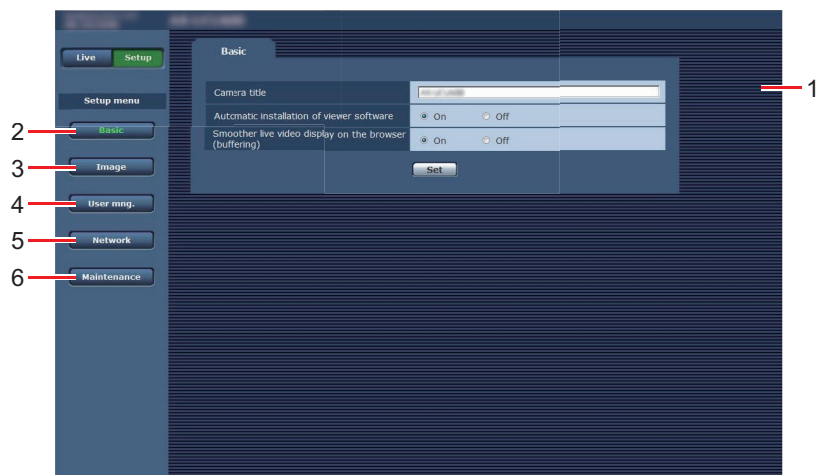

1	<b>Main area</b>	The menu screen appears.
2	<b>Basic button</b> <b>[Basic]</b>	When this button is pressed, the [Basic] screen is displayed in the main area. ➔ “[Basic] screen” (see page 131)
3	<b>Image button</b> <b>[Image]</b>	When this button is pressed, the [Image] screen is displayed in the main area. ➔ “[Image] screen” (see page 132)
4	<b>User mng. button</b> <b>[User mng.]</b>	When this button is pressed, the [User mng.] screen is displayed in the main area. ➔ “[User mng.] screen” (see page 139)
5	<b>Network button</b> <b>[Network]</b>	When this button is pressed, the [Network] screen is displayed in the main area. ➔ “[Network] screen” (see page 141)
6	<b>Maintenance button</b> <b>[Maintenance]</b>	When this button is pressed, the [Maintenance] screen is displayed in the main area. ➔ “[Maintenance] screen” (see page 145)

## [Basic] screen

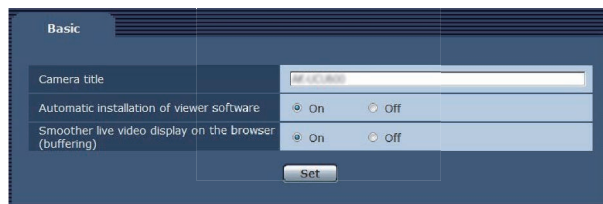

\_\_\_ indicates factory default settings.

Item	Setting value	Setting details
<b>Camera title</b>		<p>Input the name of the camera here.</p> <p>When the [Set] button is clicked, the input name appears in the camera title display area.</p> <ul style="list-style-type: none"> <li>The factory default setting is the model number of the unit.</li> <li>You can enter between 0 to 20 half-size characters.</li> <li>Characters that can be used               <ul style="list-style-type: none"> <li>Half-size numeric characters: 0123456789</li> <li>Half-size alphabetical characters (upper and lower cases): ABCDEFGHIJKLMNOPQRSTUVWXYZ abcdefghijklmnopqrstuvwxyz</li> <li>Symbols: !#\$%()*+,-./:;&lt;=&gt;@[^_`{}~\</li> </ul> </li> </ul>
<b>Automatic installation of viewer software</b>	<p><u>On</u></p> <p>Off</p>	<p>One of the following settings is selected for the automatic installation of the plug-in viewer software.</p> <p><b>On</b> The plug-in viewer software is automatically installed.</p> <p><b>Off</b> The plug-in viewer software is not automatically installed.</p>
<b>Smoother live video display on the browser (buffering)</b>	<p><u>On</u></p> <p>Off</p>	<p>Configure settings for displaying images from the unit on the plug-in viewer software.</p> <p><b>On</b> Temporarily store images from the unit onto the personal computer for smoother display.</p> <p><b>Off</b> Do not temporarily store images from the unit onto the personal computer, and display them in real time.</p> <ul style="list-style-type: none"> <li>Images and audio cannot be viewed or listened to on personal computers on which the "Network Camera View 4S" plug-in viewer software is not installed.</li> <li>You can view the number of times the plug-in software was installed under the [Product info.] tab in the [Maintenance] menu of the unit's [Setup] screen.</li> </ul>

## [Image] screen

### [Video over IP] tab

The JPEG image and H.264 image settings as well as the settings related to image quality are selected on this screen.

#### Initial display settings for “Live” page

Set initial display settings for the [Live] screen.

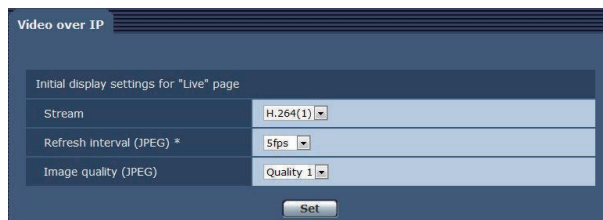

\_\_\_ indicates factory default settings.

Item	Setting value	Setting details
<b>Stream</b>	H.264 (1) H.264 (2) H.264 (3) H.264 (4) JPEG (1) JPEG (2) JPEG (3)	Select the type of images to display in the [Live] screen.  <b>H.264 (1)</b> Display videos (H.264(1)).  <b>H.264 (2)</b> Display videos (H.264(2)).  <b>H.264 (3)</b> Display videos (H.264(3)).  <b>H.264 (4)</b> Display videos (H.264(4)).  <b>JPEG (1)</b> Display still images (JPEG(1)).  <b>JPEG (2)</b> Display still images (JPEG(2)).  <b>JPEG (3)</b> Display still images (JPEG(3)).
<b>Refresh interval (JPEG)</b>	<ul style="list-style-type: none"> <li>● <b>59.94 Hz</b> 1fps 2fps 3fps <u>5fps</u> 6fps*1 10fps*1 15fps*1 30fps*1</li> <li>● <b>50 Hz</b> 1fps 2fps <u>5fps</u> 10fps*1 12.5fps*1 25fps*1</li> </ul>	Set the frame rate for JPEG images. <ul style="list-style-type: none"> <li>● The frame rate may be slower than the specified value depending on the network environment, resolution, image quality, simultaneous access count, etc.</li> <li>● If images are not transmitted at the specified frame rate, lowering the resolution or image quality may result in transmissions closer to the specified value.</li> </ul> *1: When [H.264 transmission] is set to [On], the frame rate may be slower than the specified value in some cases.
<b>Image quality (JPEG)</b>	<u>Quality1</u> Quality2	When displaying JPEG images in the Live screen, set the quality of the first image.  <b>Quality1</b> Image quality 1  <b>Quality2</b> Image quality 2



## JPEG

Set the resolution and quality settings (Quality1 and Quality2) for [JPEG(1)], [JPEG(2)], and [JPEG(3)]. For details on setting the H.264 images, see the following page.

➔ “H.264 (1) · H.264 (2) · H.264 (3) · H.264 (4)” (see page 134)

### NOTE

- Different resolutions must be selected for [JPEG(1)] to [JPEG(3)]. The same resolution cannot be selected for separate JPEG images.

JPEG		
JPEG(1)	Image capture size	1920x1080
	Image quality	Quality 1: 5 Normal, Quality 2: 8
JPEG(2)	Image capture size	640x360
	Image quality	Quality 1: 5 Normal, Quality 2: 8
JPEG(3)	Image capture size	320x180
	Image quality	Quality 1: 5 Normal, Quality 2: 8
Set		

\_\_\_ indicates factory default settings.

Item	Setting value	Setting details
<b>Image capture size</b>	1920x1080 1280x720 640x360 320x180 160x90	Select from the resolutions for the images to be displayed when displaying JPEG images.  <ul style="list-style-type: none"> <li>• <b>Factory settings</b> JPEG (1) : <u>1920×1080</u> JPEG (2) : <u>640×360</u> JPEG (3) : <u>320×180</u></li> </ul>
<b>Image quality</b>	0 Super fine 1 Fine 2 3 4 5 Normal 6 7 8 9 Low	Specify the JPEG image quality (2 types) for each resolution.  <ul style="list-style-type: none"> <li>• <b>Factory settings</b> Quality 1 : <u>5 Normal</u> Quality 2 : <u>8</u></li> </ul>

## H.264 (1) · H.264 (2) · H.264 (3) · H.264 (4)

Specify the [Max bit rate (per client)], [Image capture size], [Image quality], and other settings for H.264 images. [Windows]

For details on setting the JPEG images, see the following page.

➔ “JPEG” (see page 133)

- Example of when the screen is [H.264(1)].

\_\_\_ indicates factory default settings.

Item	Setting value	Setting details
<b>H.264 transmission</b>	On Off	<p>Set whether to transmit H.264 images.</p> <p><b>On</b> H.264 images are transmitted.</p> <p><b>Off</b> H.264 images are not transmitted.</p> <ul style="list-style-type: none"> <li>• When [On] has been selected as the [H.264 transmission] setting, both H.264 images and JPEG images can be displayed on the [Live] screen.</li> <li>• When [On] has been selected as the [H.264 transmission] setting, the frame rate for JPEG images may become slower.</li> </ul>
<b>Internet mode (over HTTP)</b>	On Off	<p>Set whether to transmit the H.264 images via the Internet. H.264 images can be transmitted using the same broadband router settings as when transmitting JPEG images.</p> <p><b>On</b> The H.264 images are transmitted using the HTTP port. For details on setting the HTTP port number, see the following page. ➔ “HTTP port” (see page 142)</p> <p><b>Off</b> The H.264 images are transmitted using the UDP port.</p> <ul style="list-style-type: none"> <li>• When [On] is set, only [Unicast port (AUTO)] can be selected as the [Transmission type] setting.</li> <li>• When [On] is set, it takes a few seconds before the H.264 images are displayed.</li> <li>• When this is set to [On], H.264 images may not appear depending on the number of users accessing the unit at the same time and whether audio data exists.</li> </ul>

Item	Setting value	Setting details
<b>Image capture size</b>	<ul style="list-style-type: none"> <li>• <b>H264(1)</b> 1920 x 1080 <u>1280 x 720</u></li> <li>• <b>H264(2)</b> 1920 x 1080 1280 x 720 640 x 360 <u>320 x 180</u> 160 x 90</li> <li>• <b>H264(3)</b> 1280 x 720 640 x 360 <u>320 x 180</u> 160 x 90</li> <li>• <b>H264(4)</b> 1280 x 720 640 x 360 320 x 180 <u>160 x 90</u></li> </ul>	<p>Select the resolution for H.264 images. Selectable options will vary depending on the selected resolution setting.</p>
<b>Transmission priority</b>	Constant bit rate Frame rate Best effort Advanced VBR	<p>Set the transmission mode for H.264 images.</p> <p><b>Constant bit rate</b> Transmits H.264 images at the bit rate specified in [Max bit rate (per client)].</p> <p><b>Frame rate</b> Transmit H.264 images at the frame rate specified in [Frame rate].</p> <p><b>Best effort</b> Transmit H.264 images at a variable bit rate between the maximum and minimum specified in [Max bit rate (per client)], according to the network bandwidth.</p> <p><b>Advanced VBR</b> Transmit H.264 images at the frame rate specified in [Frame rate]. Images will be transmitted so that the average transmission volume during the duration specified in [Control time period] will be the bit rate specified in [Max bit rate (per client)].</p> <ul style="list-style-type: none"> <li>• When [Transmission priority] is set to [Frame rate] or [Advanced VBR], the number of users that can connect may decrease.</li> </ul>
<b>Burst tolerance level</b>	High Middle <u>Low</u>	<p>Select how much more than the [Max bit rate (per client)] value to allow for the H.264 bit rate.</p> <ul style="list-style-type: none"> <li>• This setting is only enabled when [Transmission priority] is set to [Advanced VBR].</li> </ul>
<b>Control time period</b>	1h 6h <u>24h</u> 1week	<p>Select the duration for which the H.264 bit rate will be controlled. Images will be transmitted so that the average transmission volume during the duration specified will be the bit rate specified in [Max bit rate (per client)].</p> <p><b>1h</b> 1 hour</p> <p><b>6h</b> 6 hour</p> <p><b>24h</b> 1 day (24 hours)</p> <p><b>1week</b> 1 week</p> <ul style="list-style-type: none"> <li>• This setting is only enabled when [Transmission priority] is set to [Advanced VBR].</li> </ul>

Item	Setting value	Setting details
<b>Frame rate</b>	<ul style="list-style-type: none"> <li>● <b>59.94 Hz</b> 5fps 15fps <u>30fps</u> 60fps</li> <li>● <b>50 Hz</b> 5fps 12.5fps <u>25fps</u> 50fps</li> </ul>	<p>Set the frame rate for H.264 images.</p> <ul style="list-style-type: none"> <li>● The [Frame rate] is limited by the [Max bit rate (per client)] setting. The actual frame rate may be lower than the specified value.</li> <li>● This setting is only enabled when [Transmission priority] is set to [Frame rate] or [Advanced VBR].</li> <li>● [H.264(1)] is fixed at 60 fps (for 59.94 Hz) and 50 fps (for 50 Hz).</li> <li>● 60 fps (for 59.94 Hz) and 50 fps (for 50 Hz) cannot be selected for [H.264(2)] to [H.264(4)].</li> </ul>
<b>Max bit rate (per client)</b>	64kbps 128kbps 256kbps 384kbps 512kbps 768kbps 1024kbps 1536kbps 2048kbps 3072kbps 4096kbps 6144kbps 8192kbps 10240kbps 12288kbps 14336kbps 16384kbps 20480kbps 24576kbps	<p>Specify the H.264 bit rate per client. When [Transmission priority] is set to [Best effort], specify the maximum and minimum bit rate.</p> <ul style="list-style-type: none"> <li>● The H.264 bit rate is limited by [Bandwidth control (bitrate)] under the [Network] tab of the [Network] screen. With a bit rate other than [64kbps], the actual bit rate may be lower than the specified value. ➡ “Bandwidth control(bitrate)” (see page 143)</li> <li>● The range of H.264 bit rates that can be specified varies depending on the resolution. <ul style="list-style-type: none"> <li>● 160×90: 64kbps to 2048kbps</li> <li>● 320×180, 640×360: 64kbps to 4096kbps</li> <li>● 1280×720: 256kbps to 8192kbps</li> <li>● 1920×1080: 512kbps to 14336kbps</li> <li>● 1920×1080 (60fps), 1280×720 (60fps): 1024kbps to 24576kbps</li> </ul> </li> <li>● Factory settings H.264(1): 4096kbps H.264(2): 1536kbps H.264(3): 1024kbps H.264(4): 512kbps</li> </ul>
<b>Image quality</b>	Low (Motion priority) <u>Normal</u> Fine (Image quality priority)	<p>Select the image quality for H.264 images.</p> <ul style="list-style-type: none"> <li>● This setting is only enabled when [Transmission priority] is set to [Constant bit rate] or [Best effort].</li> </ul>
<b>Refresh interval</b>	<ul style="list-style-type: none"> <li>● <b>59.94 Hz</b> 0.2s 0.25s 0.33s 0.5s <u>1s</u> 2s 3s 4s 5s</li> <li>● <b>50 Hz</b> 0.2s 0.5s <u>1s</u> 2s 3s 4s 5s</li> </ul>	<p>Set the refresh interval for H.264 images (I-frame interval: 0.2 to 5 seconds).</p> <ul style="list-style-type: none"> <li>● If errors occur frequently in the network environment, decreasing the refresh interval will reduce image distortions. However, the frame rate may decrease.</li> </ul>

Item	Setting value	Setting details
<b>Transmission type</b>	Unicast port (AUTO) Unicast port (MANUAL) Multicast port	<p>Set the transmission format for H.264 images.</p> <p><b>Unicast port (AUTO)</b> Up to 14 users can access a single camera at the same time. [Unicast port] will be configured automatically when images are sent from the camera. We recommend selecting the [Unicast port (AUTO)] setting when the port number transmitting the H.264 images does not need to be fixed (e.g., during use within a network).</p> <p><b>Unicast port (MANUAL)</b> Up to 14 users can access a single camera at the same time. [Unicast port] must be configured manually when images are sent from the camera. When transmitting H.264 images via the Internet, configure a fixed transmission port number for the broadband router (hereafter referred to as "router"). ➡ "HTTP port" (see page 142) For details, refer to the operating instructions for the router.</p> <p><b>Multicast port</b> An unlimited number of users can access a single camera at the same time. When transmitting H.264 images via multicast, enter the [Multicast address], [Multicast port], and [Multicast TTL/HOPLimit]. When transmitting H.264 images via multicast, use a multicast-compatible router, and specify the transmission destination. In such cases, configure settings so that H.264 images are not transmitted to other connected devices (e.g., AK-HRP1000). IP communication with the camera may be disabled if you transmit H.264 images to the AK-HRP1000.</p> <p><b>Maximum number of simultaneous accesses</b> Up to 14 users (consisting of users receiving H.264 images and users receiving JPEG images) can access the unit at the same time. However, depending on the settings for the [Bandwidth control(bit rate)] and [Max bit rate (per client)], the number of users who can access the unit may be limited to less than 14. A message indicating the access limit will appear if the number of users exceeds 14. When [Transmission type] is set to [Multicast port] for [H.264], the second and subsequent users receiving H.264 images will not be counted toward the total access count.</p>
<b>Unicast port</b>	1024 to 50000	<p>Set the unicast port number (used when sending images from the unit). This needs to be set when [Transmission type] is set to [Unicast port(MANUAL)].</p> <ul style="list-style-type: none"> <li>● <b>Factory settings</b> H.264 (1) : <u>32004</u> H.264 (2) : <u>32014</u> H.264 (3) : <u>32024</u> H.264 (4) : <u>32034</u></li> <li>● Only even numbers can be specified.</li> <li>● The port number cannot be set to 10670.</li> </ul>
<b>Multicast address</b>	224.0.0.0 to 239.255.255.255	<p>Set the multicast IP address. Images will be sent to the specified IP address. This needs to be set when [Transmission type] is set to [Multicast port].</p> <ul style="list-style-type: none"> <li>● <b>Factory settings</b> H.264 (1) : <u>239.192.0.20</u> H.264 (2) : <u>239.192.0.21</u> H.264 (3) : <u>239.192.0.22</u> H.264 (4) : <u>239.192.0.23</u></li> <li>● <b>Verify the usable multicast IP addresses before setting this.</b></li> </ul>

Item	Setting value	Setting details
<b>Multicast port</b>	1024 to <u>37004</u> to 50000	<p>Enter the multicast port number (used when sending images from the unit). This needs to be set when [Transmission type] is set to [Multicast port].</p> <ul style="list-style-type: none"><li>• Only even numbers can be specified.</li><li>• The port number cannot be set to 10670.</li></ul>
<b>Multicast TTL/HOP Limit</b>	1 to <u>16</u> to 254	<p>Enter the TTL/HOP Limit value for multicast. This needs to be set when [Transmission type] is set to [Multicast port].</p> <ul style="list-style-type: none"><li>• When transmitting H.264 images via the Internet, transmitted images may not appear depending on proxy server settings, firewall settings, etc. In such cases, consult your network administrator.</li><li>• When displaying multicast images on a personal computer with multiple LAN cards installed, disable the LAN cards that are not used for reception.</li></ul>

## [User mng.] screen

The users and personal computers (IP addresses) that can access the unit from personal computers are registered in the [User mng.] screen.

The [User mng.] screen consists of [User auth.] tab and [Host auth.] tab.

### [User auth.] tab

Click the [User auth.] tab of [User mng.] screen.

Configure the user authorization settings for the personal computers that can access the unit.

Up to 18 users can be registered.

#### NOTE

- If user authentication fails more than 8 times within a 30-second period from the same IP address (personal computer), access to the unit will be disabled for a certain period.

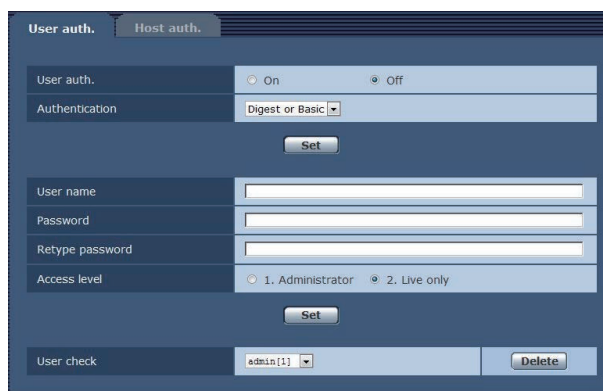

\_\_\_ indicates factory default settings.

Item	Setting value	Setting details
<b>User auth.</b>	On <u>Off</u>	Set whether to perform user authorization. <b>On</b> Perform user authentication. <b>Off</b> Do not perform user authentication.
<b>Authentication</b>	<u>Digest or Basic</u> Digest Basic	Specify the method of user authentication to use. The authorization configured here is used for authentication when accessing the web screen. Digest authentication will always be used for connection with the controller. <b>Digest or Basic</b> Use digest authentication or basic authentication. <b>Digest</b> Use digest authentication. <b>Basic</b> Use basic authentication. • <b>If you change the [Authentication] setting, close the web browser and perform access again.</b>
<b>User name</b>		Enter the user name. • <b>Maximum number of characters</b> 1 to 32 half-size characters • <b>Invalid characters</b> Full-size and half-size " : ; & \ symbols • <b>If you enter a new name for a registered user and click the [Set] button, the user information will be overwritten.</b>
<b>Password</b> <b>Retype password</b>		Enter the password. • <b>Maximum number of characters</b> 4 to 32 half-size characters • <b>Invalid characters</b> Full-size and half-size " &

Item	Setting value	Setting details
<b>Access level</b>	1. Administrator 2. <u>Live only</u>	Select one of the following settings as the user access level. <ul style="list-style-type: none"> <li>• <b>1. Administrator</b> This access level allows the user to perform all the unit's operations.</li> <li>• <b>2. Live only</b> This access level enables only [Live] screen to be displayed. The unit cannot be operated or set.</li> </ul>
<b>User check</b>		You can view registered users by clicking [▼] for [User check]. A registered user is indicated in the form of "Registered user name [Access level]." (Example: admin[1]) You can delete selected users by clicking the [Delete] button at the right.

### [Host auth.] tab

Click the [Host auth.] tab of [User mng.] screen.

Configure the host authorization settings that restrict the personal computers (IP addresses) that can access the unit.

\_\_\_ indicates factory default settings.

Item	Setting value	Setting details
<b>Host auth.</b>	On <u>Off</u>	Set whether to perform host authorization. <ul style="list-style-type: none"> <li><b>On</b> Perform host authentication.</li> <li><b>Off</b> Do not perform host authentication.</li> </ul>
<b>IP address</b>		The IP address of the personal computer from which access to the unit is allowed is input here. The host name cannot be input as the IP address. <ul style="list-style-type: none"> <li>• When the "IP address/subnet mask length" is input, the personal computers which are allowed to access the camera can be restricted on a subnet by subnet basis. If, for instance, "192.168.0.1/24" has been input and the [1. Administrator] setting has been selected as the [Access level] setting, the personal computers from "192.168.0.1" to "192.168.0.254" will be able to access the camera at the [1. Administrator] access level.</li> <li>• When an already registered IP address is input and the [Set] button is clicked, the host information will be overwritten.</li> </ul>
<b>Access level</b>	1. Administrator 2. <u>Live only</u>	Set the host access level. <ul style="list-style-type: none"> <li><b>1. Administrator</b> This access level allows the user to perform all the unit's operations.</li> <li><b>2. Live only</b> This access level enables only [Live] screen to be displayed. The unit cannot be operated or set.</li> </ul>
<b>Host check</b>		You can view registered host IP addresses by clicking [▼] for [Host check]. A host is indicated in the form of "Registered IP address [Access level]." (Example: 192.168.0.21 [1]) You can delete selected hosts (IP addresses) by clicking the [Delete] button at the right.



## [Network] screen

Configure network settings in the [Network] screen.

- The following information is required to configure network settings. Consult your network administrator or Internet service provider.
  - IP address
  - Subnet mask
  - Default gateway (when using a gateway server or router)
  - HTTP port

### IPv4 network

The screenshot shows a web interface for network configuration. Under the 'IPv4 network' section, there are three rows of input fields:

- IP address(IPv4):** 192 . 168 . 0 . 20
- Subnet mask:** 255 . 255 . 255 . 0
- Default gateway:** 192 . 168 . 0 . 1

\_\_\_ indicates factory default settings.

Item	Setting value	Setting details
<b>IP address(IPv4)</b>	<u>192.168.0.20</u>	Enter the IP address of the unit. Input an address that will not duplicate an existing IP address which has been set for a personal computer or another network camera.
<b>Subnet mask</b>	<u>255.255.255.0</u>	Enter the subnet mask of the unit.
<b>Default gateway</b>	<u>192.168.0.1</u>	Enter the default gateway of the unit. <ul style="list-style-type: none"> <li>• Multiple IP addresses cannot be used for the default gateway.</li> </ul>

## Common

Common	
HTTP port	<input type="text" value="80"/> (1-65535)
ROP port	<input type="text" value="49152"/> (49152/49200-49299)
Line speed	<input type="text" value="Auto"/>
Max RTP packet size	<input checked="" type="radio"/> Unlimited(1500byte) <input type="radio"/> Limited(1280byte)
HTTP max segment size(MSS)	<input type="text" value="Unlimited(1460byte)"/>
Bandwidth control(bit rate)	<input type="text" value="Unlimited"/>
Easy IP Setup accommodate period	<input type="radio"/> 20min <input checked="" type="radio"/> Unlimited
<input type="button" value="Set"/>	
Recommended network setting for internet <input type="button" value="Set"/>	

\_\_\_ indicates factory default settings.

Item	Setting value	Setting details
<b>HTTP port</b>	1 to <u>80</u> to 65535	Individually assign the HTTP port numbers (i.e., port numbers used for access from a web browser). <ul style="list-style-type: none"> <li>The following port numbers are used by the unit so they cannot be used. 20 / 21 / 23 / 25 / 42 / 53 / 67 / 68 / 69 / 110 / 123 / 161 / 162 / 443 / 554 / 995 / 10669 / 10670 / 49152 / 49200 to 49299 / 59000 to 61000</li> </ul>
<b>ROP port</b>	<u>49152</u> 49200 to 49299	Individually assign the port numbers used for connecting to the ROPs.
<b>Line speed</b>	<u>Auto</u> 100M-Full 100M-Half 10M-Full 10M-Half	Set the data line speed. <p><b>Auto</b> The line speed is set automatically.</p> <p><b>100M-Full</b> 100 Mbps full duplex</p> <p><b>100M-Half</b> 100 Mbps half duplex</p> <p><b>10M-Full</b> 10 Mbps full duplex</p> <p><b>10M-Half</b> 10 Mbps half duplex</p> <ul style="list-style-type: none"> <li>Normally, it is recommended that the [Auto] default setting be used.</li> </ul>

Item	Setting value	Setting details
<b>Max RTP packet size</b>	<u>Unlimited (1500byte)</u> Limited (1280byte)	Specify whether to limit the size of RTP packets sent from the camera when using RTP to view camera images.  <b>Unlimited (1500byte)</b> Unlimited (1500 byte)  <b>Limited (1280byte)</b> Limited (1280 byte)  <ul style="list-style-type: none"> <li>• Normally, it is recommended that the [Unlimited(1500byte)] default setting be used.</li> <li>• Select [Limited(1280byte)] when the packet size of the used communication line is limited. For details on the maximum packet size of communication lines, consult your network administrator.</li> </ul>
<b>HTTP max segment size(MSS)</b>	<u>Unlimited (1460byte)</u> Limited (1280byte) Limited (1024byte)	Select whether to limit the maximum segment size (MSS) transmitted by a camera when viewing camera images using HTTP.  <b>Unlimited (1460byte)</b> Unlimited (1460 byte)  <b>Limited (1280byte)</b> Limited (1280 byte)  <b>Limited (1024byte)</b> Limited (1024 byte)  <ul style="list-style-type: none"> <li>• Normally, it is recommended that the [Unlimited(1460byte)] default setting be used.</li> <li>• Select [Limited(1024byte)] or [Limited(1280byte)] when the maximum segment size (MSS) of the used communication line is limited. For details on the maximum segment size (MSS) of communication lines, consult your network administrator.</li> </ul>
<b>Bandwidth control(bitrate)</b>	<u>Unlimited</u> 64kbps 128kbps 256kbps 384kbps 512kbps 768kbps 1024kbps 2048kbps 4096kbps 8192kbps	Set the amount of data to be distributed.  <ul style="list-style-type: none"> <li>• When [Bandwidth control (bitrate)] is set to a low value, the SnapShot button may not work depending on the use environment. In such a case, select [JPEG] with the [Compression] button in the [Live] screen and execute SnapShot when distributing images in the smallest resolution.</li> </ul>
<b>Easy IP Setup accommodate period</b>	20min <u>Unlimited</u>	Set the time for enabling the operation of the network settings from the Easy IP Setup Software.  <b>20min</b> The setting operations from the Easy IP Setup Software are enabled for 20 minutes after the unit has started.  <b>Unlimited</b> The camera setting operations from the Easy IP Setup Software are enabled at all times.  <ul style="list-style-type: none"> <li>• The camera screen can be opened because the camera display in the Easy IP Setup Software is constantly enabled.</li> <li>• For details on the address settings of each server, consult you network administrator.</li> </ul>

Item	Setting value	Setting details
<b>Recommended network setting for internet</b>		<p>Perform the recommended settings to connect the camera to the Internet.</p> <p>Clicking the [Set] button displays a dialog box telling the user that item settings will be changed. After confirming this, click the [OK] button.</p> <ul style="list-style-type: none"> <li>• <b>[Image] screen</b> <ul style="list-style-type: none"> <li>JPEG (1)               <ul style="list-style-type: none"> <li>Image capture size: 640×360</li> </ul> </li> <li>JPEG (2)               <ul style="list-style-type: none"> <li>Image capture size: 320×180</li> </ul> </li> <li>JPEG (3)               <ul style="list-style-type: none"> <li>Image capture size: 160×90</li> </ul> </li> <li>H.264 (1) · H.264 (2) · H.264 (3) · H.264 (4) [Windows]               <ul style="list-style-type: none"> <li>Internet mode (over HTTP) : On</li> <li>Transmission priority : Best effort</li> </ul> </li> <li>H.264 (1) [Windows]               <ul style="list-style-type: none"> <li>Image capture size: 1280×720</li> <li>Max bit rate (per client) : Max1024 kbps, Min1024 kbps</li> </ul> </li> <li>H.264 (2) [Windows]               <ul style="list-style-type: none"> <li>Image capture size: 640×360</li> <li>Max bit rate (per client) : Max1024 kbps, Min128 kbps</li> </ul> </li> <li>H.264 (3) [Windows]               <ul style="list-style-type: none"> <li>Image capture size: 320×180</li> <li>Max bit rate (per client) : Max1024 kbps, Min128 kbps</li> </ul> </li> <li>H.264 (4) [Windows]               <ul style="list-style-type: none"> <li>Image capture size: 160×90</li> <li>Max bit rate (per client) : Max1024 kbps, Min128 kbps</li> </ul> </li> </ul> </li> <li>• <b>[Network] screen</b> <ul style="list-style-type: none"> <li>Max RTP packet size: Limited (1280 byte)</li> <li>HTTP max segment size (MSS) : Limited (1280 byte)</li> </ul> </li> </ul>

## [Maintenance] screen

Among the various maintenance operations performed on this screen are system log checks, software version check and initialization of the unit.

The Maintenance screen consists of three tabs: [Product info.], [Default reset] and [Back up].

### [Product info.] tab

The versions of the unit's software can be checked on this screen.

The [Model no.], [MAC address], [Firmware version] and other information about the unit is displayed.

Product info.		Default reset	Back up	
Model no.	A8-13-74-76-00-00			
MAC address	A8-13-74-76-00-00			
Firmware version	VERSION	03.01-000-0C.40		
	CPU Software	SOFTWARE NETWORK	00.00-000-01.30	
			00.00-000-01.20	
	FPGA	UHD FPGA	00.00-000-01.30	
		HS FPGA	00.00-000-01.30	
		RETURN FPGA1	00.00-000-02.30	
		RETURN FPGA2	00.00-000-02.00	
		MAIN FPGA	00.00-000-01.30	
		INCOM FPGA	03.01-000-01.00	
		USC FPGA	00.00-000-01.30	
Viewer software installation counter	0			

Item	Display description
<b>Model no.</b>	Display the unit's model number.
<b>MAC address</b>	Display the unit's MAC address.
<b>Firmware version</b>	<p><b>CPU Software - SOFTWARE</b> Display the software version of this unit.</p> <p><b>CPU Software - NETWORK</b> Display the software version of the network.</p> <p><b>FPGA - UHD FPGA</b> Display the image processing (4K) FPGA version.</p> <p><b>FPGA - HS FPGA</b> Display the image processing (HS) FPGA version.</p> <p><b>FPGA - RETURN FPGA1</b> Display the return image processing FPGA1 version.</p> <p><b>FPGA - RETURN FPGA2</b> Display the return image processing FPGA2 version.</p> <p><b>FPGA - MAIN FPGA</b> Display the FPGA version of this unit.</p> <p><b>FPGA - INCOM FPGA</b> Display the power and audio management FPGA version.</p> <p><b>FPGA - USC FPGA</b> Display the UHD output conversion FPGA version.</p>
<b>Viewer software installation counter</b>	The number of plug-in viewer software applications which have been installed automatically from the unit is displayed by this counter.

### [Default reset] tab

The unit's setting data or HTML is initialized and the unit is restarted on this screen.

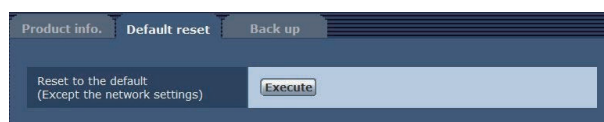

Item	Setting details
<b>Reset to the default (Except the network settings)</b>	<p>When the [Execute] button is clicked, the unit's settings are returned to their defaults.</p> <ul style="list-style-type: none"> <li>The login user name and password will also return to their defaults (admin/12345).</li> <li>When the initialization operation is started, no operations can be undertaken for about 3 minutes.</li> <li>The following setting items will not be returned to defaults. <ul style="list-style-type: none"> <li>All settings under [IPv4 network]</li> <li>[HTTP port]</li> <li>[Line speed]</li> <li>[Bandwidth control (bit rate)]</li> </ul> </li> </ul>

## [Back up] tab

On this screen, the unit's network settings can be saved to a personal computer or settings stored on a personal computer can be applied on the unit.

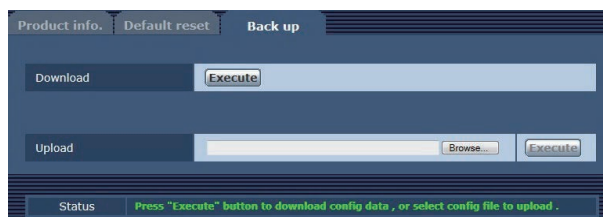

Item	Setting details
<b>Download</b>	Save the unit's network settings to a personal computer. ➔ "Saving the unit's network settings to a personal computer [Download]" (see page 146)
<b>Upload</b>	Upload a unit configuration file that was saved to a personal computer with the download function. ➔ "Applying settings stored on a personal computer to the unit [Upload]" (see page 146)

### Saving the unit's network settings to a personal computer [Download]

Follow the procedure below to save the unit's network settings to a personal computer.

- Do not turn off the unit's power during downloading.
- Do not attempt to perform any operations during downloading. Wait until downloading is completed.

#### 1. Click the [Execute] button of [Download].

The save destination dialog box appears.

#### 2. Specify the save destination folder and then click the [OK] button.

The data is saved.

### Applying settings stored on a personal computer to the unit [Upload]

Follow the procedure below to upload a unit configuration file that was saved to a personal computer with the download function [Download] and then apply the settings on the unit.

- For the data to use for uploading, use a file downloaded with the unit.  
Furthermore, do not change the extension (.ndt) of the downloaded file.
- Do not turn off the unit's power during uploading.
- Do not attempt to perform any operations during uploading. Wait until uploading is completed.

#### 1. Click the [Browse] button of [Upload], and specify the downloaded software.

#### 2. Click the [Execute] button.

A message dialog box appears.

#### 3. Click the [OK] button.

Uploading begins.

A message dialog box appears when uploading completes.

#### 4. Click the [OK] button.

The unit restarts automatically.

# Web Screen (AK-NP600)

## Network settings

### Software

Download EasyIP Setup Tool Plus from the following website and then install them. [Windows]

- **Download URL**  
<https://pro-av.panasonic.net/en/>

### EasyIP Setup Tool Plus

This software sets the unit's network settings.

➔ "Using EasyIP Setup Tool Plus to set the unit's settings" (see page 147)

## Using EasyIP Setup Tool Plus to set the unit's settings

The settings related to the unit's network can be set using the supplied EasyIP Setup Tool Plus.

When multiple of this unit are to be set, they each need to be set individually.

If setting cannot be done using the EasyIP Setup Tool Plus, make the individual settings for this unit and the personal computer in [MAINTENANCE] > [NETWORK(MOIP)] > [1GbE] in the CCU menu.

➔ "NETWORK(1GbE)" (see page 107)

### NOTE

- If, after the network settings have been set, another device on the same network has the same IP address, the network operations will not be performed properly. Set the IP address in such a way that it does not duplicate an existing IP address.
- Do not set network settings from a multiple number of EasyIP Setup Tool Plus programs at the same time for a single camera. When connected from more than one PC, the settings of this unit can only be changed from the PC that was connected first.
- EasyIP Setup Tool Plus cannot be used from a different subnet via a router.
- Changes to the settings of this unit using the EasyIP Setup Tool Plus are performed with authentication from an account in the web screen, therefore changes are not possible if the initial account for the web screen is not yet set.  
 ➔ "Displaying the web screen using a personal computer" (see page 149)

### Setting Procedure

1. Start the EasyIP Setup Tool Plus.
2. Click the [Search] button.

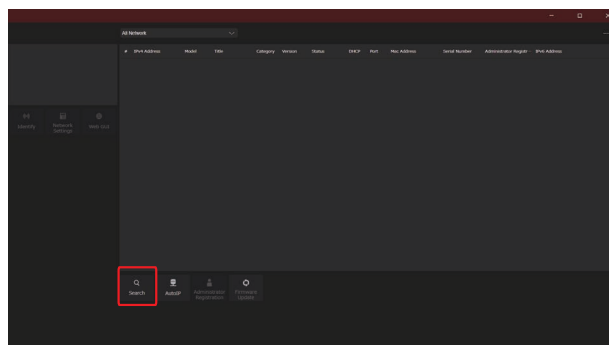

- You can set the Network to be used for the search in the selection menu at the top of the screen.

### 3. Select the camera to configure and click the [Network Settings] button.

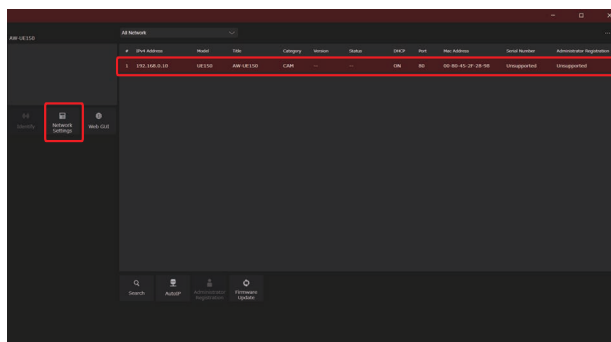

- The web screen for the selected camera is displayed when you click the [Web GUI] button.

### 4. Input the network items, and click the [Setup] button.

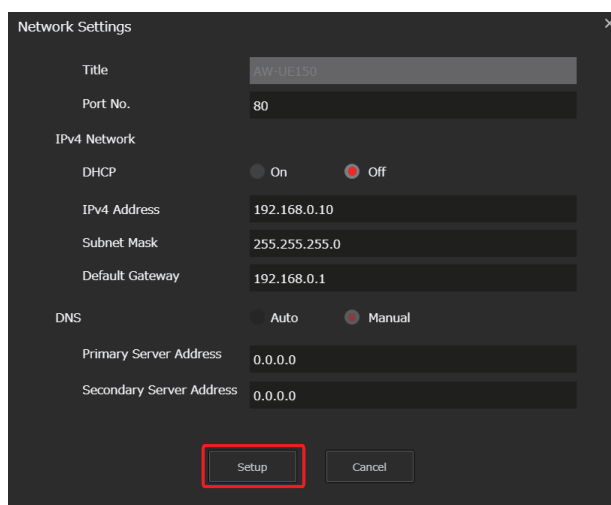

- Port No. settings are not supported, so do not set.

### 5. Enter the user name and password registered in the web screen (AK-NP600), then click the [OK] button.

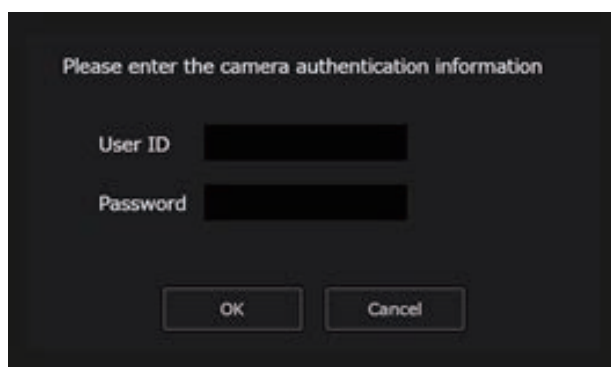

- Enter the user name and password that was set for the initial account or was set in the User management screen [User mng.] in the web screen.
  - ➡ "Displaying the web screen using a personal computer" (see page 149)
  - ➡ "User management screen [User mng.]" (see page 170)
- After the [OK] button is clicked, it takes about 2 minutes for the settings in the unit to be completed. If this unit is turned off or the LAN cable is disconnected before the settings are completed, the settings will be invalidated. In this case, repeat the steps to set the settings.

#### NOTE

- The unit does not support IPv6.
- This unit does not support "Administrator Registration", and "Firmware Update" from EasyIP Setup Tool Plus.
- When a firewall (including software) has been introduced, enable access to all the UDP ports.
- For details about EasyIP Setup Tool Plus, refer to the Help page.



## Displaying the web screen (AK-NP600)

Connect the LAN2 connector on this unit and a personal computer and make a variety of settings in a web browser.

Use a LAN crossover cable to directly connect the LAN2 connector on this unit and a personal computer. When connecting via a switching hub, etc., use a LAN straight cable.

### Notice regarding the Web screen

#### IP address and subnet mask

Select an IP address for the personal computer within the private address range while ensuring that it is different from the address of the unit. Set the subnet mask to the same address as the unit.

- **Unit's IP address and subnet mask (factory settings)**

IP address	192.168.0.52
Subnet mask	255.255.255.0

#### NOTE

- In the factory settings, the variable range for private addresses is between 192.168.0.1 and 192.168.0.255.

#### Personal computer environment required to display the Web screen

For details on the personal computer environment required to display the Web screen, refer to following page.

➔ "Personal computer requirements" (see page 11)

### Displaying the web screen using a personal computer

Screens from Windows (Microsoft Edge) are used as examples in this manual. There will be some differences in how the screen appears in other browsers, but the procedures will be the same.

#### 1. Start the web browser of the personal computer.

Use one of the web browsers below depending on the operating system installed in the personal computer.

Installed OS	Web browser
Windows	Microsoft Edge
	Internet Explorer 11
	Google Chrome
macOS	Safari

#### 2. Enter the IP address you configured on the EasyIP Setup Tool Plus in the address bar of the web browser.

- Example of input  
http://registered URL  
http://192.168.0.52

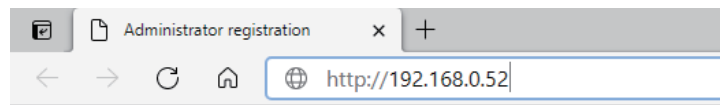

- If this unit is within a local network, make the settings for the proxy server from the web browser so that the proxy server is not used for the local address.

### 3. Sets the initial account.

If the web screen is set to be shown in the initial state, the initial account setting screen is displayed.

Set the user name and password.

#### NOTE

- Do not use a string of characters that can be easily guessed by a third party.
- Change your password regularly.
- Use at least 3 of the following 4 character types in a password of at least 8-characters in length.
  - Upper case alphabet
  - Lower case alphabet
  - Numbers
  - Symbols (! # \$ % ' ( ) \* + , - . / ? @ [ ] ^ \_ ` ~)
- If a password is set that does not follow the above policy, the user assumes responsibility for operation, with an adequate understanding of the security risks to the installation environment, etc.
- A warning message is displayed if you set a password that does not meet the recommended setting policy. To change the password, click the [Back] button and enter another password. To continue the settings after understanding the risk to security, click [Continue] and then complete the settings.
- If you have forgotten the account information you set, execute [SYSTEM] > [FACTORY INITIALIZE] in the CCU menu, and reset the user information used for network connections. The settings for this unit return to the factory settings when you execute [FACTORY INITIALIZE].
  - ➡ “Initialize the Unit Settings (INITIALIZE)” (see page 116)

#### 4. Complete registration of the initial account.

The following screen indicating registration completion is displayed after registration of the initial account is complete.

After about 10 seconds of showing this completion screen, the settings screen is automatically shown. If the screen does not transition to the settings screen even after 10 seconds have elapsed, click on the link in "please click here" to move to the settings screen manually.

This completes the procedures for registering the initial account.

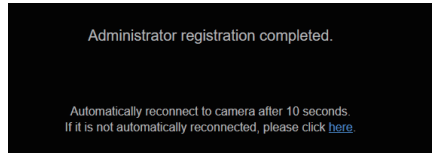

#### 5. Display the settings screen.

The web screen is displayed.

In the initial screen, the Product information screen [Product info.] is displayed, so switch if necessary.

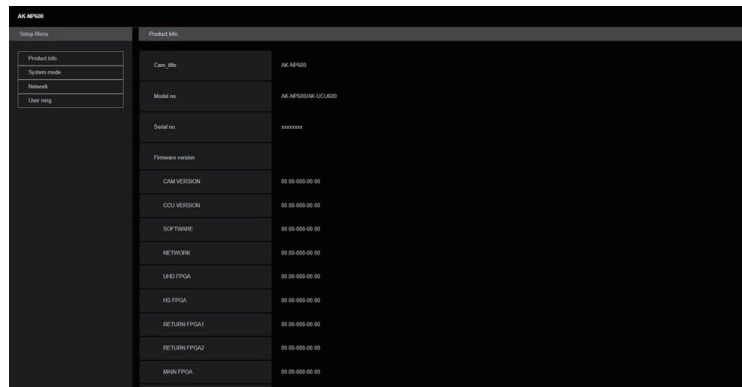

## Logging into the web screen

When the web screen is displayed, you need to enter the account information.

### NOTE

- The account input screen appears as a pop-up window in the web browser.
- Correctly enter the user name and password that were previously registered.
- It is recommended to regularly change the password.

## Web setting screen

This screen enables you to make a variety of settings for this unit.

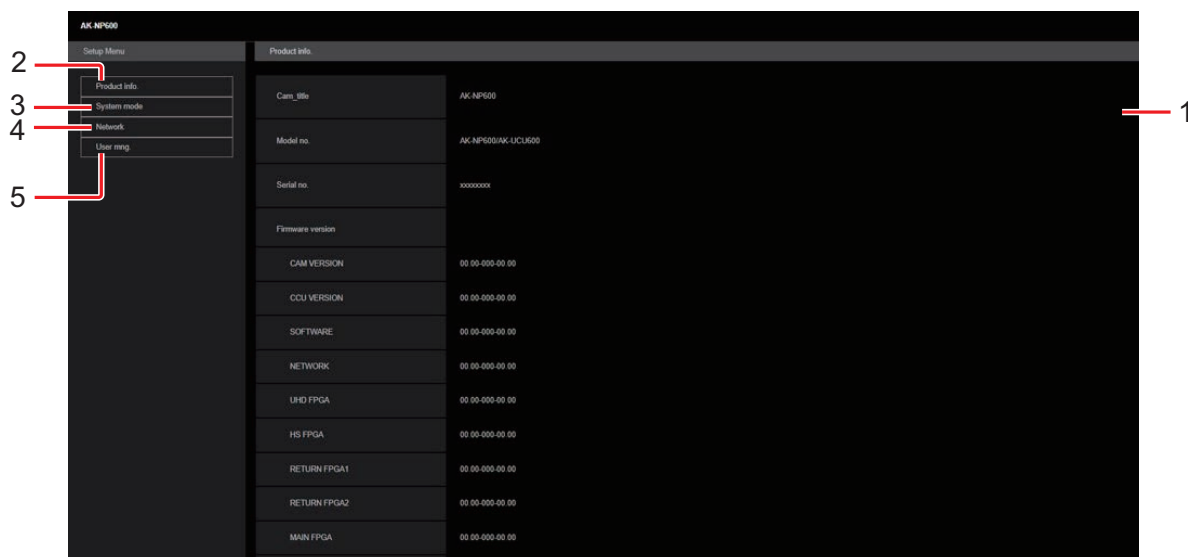

1	<b>Main area</b>	The menu screen appears.
2	<b>Product information button [Product info.]</b>	Click the button to display the Product information screen [Product info.]. ➡ "Product information screen [Product info.]" (see page 153)
3	<b>View system settings button [System mode]</b>	Click the button to display the View system settings screen [System mode]. ➡ "View system settings screen [System mode]" (see page 154)
4	<b>Network settings button [Network]</b>	Click the button to display the Network settings screen [Network]. ➡ "Network settings screen [Network]" (see page 158)
5	<b>User management settings button [User mng.]</b>	Click the button to display the User management screen [User mng.]. ➡ "User management screen [User mng.]" (see page 170)

### NOTE

- If setting values are changed from a menu or another web browser while the settings menu is being displayed, there may be a mismatch between the setting values and the displayed values. If this occurs, refresh the screen displaying the settings menu in the web browser.

## Product information screen [Product info.]

The versions of the unit's software can be checked on this screen.

The [Model no.], [Serial no.], [Firmware version] and other information about the unit is displayed.

Product Info.	
Cam_title	AK-NP600
Model no.	AK-NP600/AK-UCLU600
Serial no.	xxxxxxxx
Firmware version	
CAM VERSION	00.00.000-00.00
CCU VERSION	00.00.000-00.00
SOFTWARE	00.00.000-00.00
NETWORK	00.00.000-00.00
UHD FPGA	00.00.000-00.00
HS FPGA	00.00.000-00.00
RETURN FPGA1	00.00.000-00.00
RETURN FPGA2	00.00.000-00.00
MAIN FPGA	00.00.000-00.00

\_\_\_ indicates factory default settings.

Item	Display description
<b>Cam_title</b>	<b>AK-NP600</b> Set the camera name displayed in the header of the web screen (AK-NP600) and in EasyIP Setup Tool Plus.
<b>Model no.</b>	Display the unit's model number.
<b>Serial no.</b>	Displays the unit's serial number.
<b>Firmware version</b>	<p><b>CAM VERSION</b> Displays the software version of the camera connected to this unit.</p> <p><b>CCU VERSION</b> Displays the overall version of the unit.</p> <p><b>SOFTWARE</b> Displays the version of the application.</p> <p><b>NETWORK</b> Displays the network software version.</p> <p><b>UHD FPGA</b> Displays the version of the FPGA (UHD).</p> <p><b>HS FPGA</b> Displays the version of the FPGA (HS).</p> <p><b>RETURN FPGA1</b> Displays the version of the FPGA (RETURN1).</p> <p><b>RETURN FPGA2</b> Displays the version of the FPGA (RETURN2).</p> <p><b>MAIN FPGA</b> Displays the version of the FPGA (MAIN).</p> <p><b>INCOM FPGA</b> Displays the version of the FPGA (INCOM).</p> <p><b>MOIP FPGA</b> Displays the MOIP software version.</p>

## View system settings screen [System mode]

The View system settings screen [System mode] enables you to view the related image format, received image information, etc., when this unit is to use MoIP.

The View system settings screen [System mode] consists of [Main], [TX setting status], [Primary RX status], and [Secondary RX status].

### Main

Click [Main] in the View system settings screen [System mode].

You can view the basic settings for the unit.

Main	
Format	HS(59.94)
CCU mode	1080/59.94p

Item	Display description
<b>Format</b>	Displays the CCU format settings.
<b>CCU mode</b>	Displays the settings for the format of the signals output from the CCU.

### TX setting status

Click [TX setting status] in the View system settings screen [System mode].

You can view the format of the TX signal source.

TX setting status	
Video main format	1080/59.94p
Video monitor format	1080/59.94i
HD trunk format	1080/59.94i
Audio	Enable
Audio format	PCM48khz/24bit

Item	Display description
<b>Video main format</b>	Displays the settings for the format of images output from the main output line.
<b>Video monitor format</b>	Displays the settings for the format of images output from the monitor.
<b>HD trunk format</b>	Displays the settings for the format of the HD trunk.
<b>Audio</b>	Displays the enable/disable settings for audio output.
<b>Audio format</b>	Displays the settings for audio output format.

## Primary RX status

Click [Primary RX status] in the View system settings screen [System mode].

This will display the received data information for the SFP+ PRIMARY RX signals.

Primary RX status	
Return video format	Detect
Sampling rate	26288
Width	1920
Height	1080
HD prompter format	Undetected
Sampling rate	0
Width	0
Height	0
PGM1 format	Undetected
Sampling rate	0
Payload type	0
PGM2 format	Undetected
Sampling rate	0
Payload type	0

Item	Display description
<b>Return video format</b>	<p><b>Detect/Undetected</b> Displays whether return images are being received.</p> <p><b>Sampling rate</b> Displays the sampling rate of the received return images.</p> <p><b>Width</b> Displays the horizontal resolution of the received return images.</p> <p><b>Height</b> Displays the vertical resolution of the received return images.</p>
<b>HD prompter format</b>	<p><b>Detect/Undetected</b> Displays whether HD prompter RX is being received.</p> <p><b>Sampling rate</b> Displays the sampling rate of the received HD prompter RX.</p> <p><b>Width</b> Displays the horizontal resolution of the received HD prompter RX.</p> <p><b>Height</b> Displays the vertical resolution of the received HD prompter RX.</p>
<b>PGM1 format</b>	<p><b>Detect/Undetected</b> Displays whether PGM1 audio RX is being received.</p> <p><b>Sampling rate</b> Displays the sampling rate of the received PGM1 audio RX.</p> <p><b>Payload type</b> Displays the payload type of the received PGM1 audio RX.</p>

Item	Display description
<b>PGM2 format</b>	<p><b>Detect/Undetected</b> Displays whether PGM2 audio RX is being received.</p> <p><b>Sampling rate</b> Displays the sampling rate of the received PGM2 audio RX.</p> <p><b>Payload type</b> Displays the payload type of the received PGM2 audio RX.</p>
<b>INCOM1 format</b>	<p><b>Detect/Undetected</b> Displays whether INCOM1 audio RX is being received.</p> <p><b>Sampling rate</b> Displays the sampling rate of the received INCOM1 audio RX.</p> <p><b>Payload type</b> Displays the payload type of the received INCOM1 audio RX.</p>
<b>INCOM2 format</b>	<p><b>Detect/Undetected</b> Displays whether INCOM2 audio RX is being received.</p> <p><b>Sampling rate</b> Displays the sampling rate of the received INCOM2 audio RX.</p> <p><b>Payload type</b> Displays the payload type of the received INCOM2 audio RX.</p>

### Secondary RX status

Click [Secondary RX status] in the View system settings screen [System mode].

This will display the received data information for the SFP+ Secondary RX signals.

Secondary RX status	
Return video format	Detect
Sampling rate	26288
Width	1920
Height	1080
HD prompter format	Undetected
Sampling rate	0
Width	0
Height	0
PGM1 format	Undetected
Sampling rate	0
Payload type	0
PGM2 format	Undetected
Sampling rate	0
Payload type	0



Item	Display description
<b>Return video format</b>	<p><b>Detect/Undetected</b> Displays whether return images are being received.</p> <p><b>Sampling rate</b> Displays the sampling rate of the received return images.</p> <p><b>Width</b> Displays the horizontal resolution of the received return images.</p> <p><b>Height</b> Displays the vertical resolution of the received return images.</p>
<b>HD prompter format</b>	<p><b>Detect/Undetected</b> Displays whether HD prompter RX is being received.</p> <p><b>Sampling rate</b> Displays the sampling rate of the received HD prompter RX.</p> <p><b>Width</b> Displays the horizontal resolution of the received HD prompter RX.</p> <p><b>Height</b> Displays the vertical resolution of the received HD prompter RX.</p>
<b>PGM1 format</b>	<p><b>Detect/Undetected</b> Displays whether PGM1 audio RX is being received.</p> <p><b>Sampling rate</b> Displays the sampling rate of the received PGM1 audio RX.</p> <p><b>Payload type</b> Displays the payload type of the received PGM1 audio RX.</p>
<b>PGM2 format</b>	<p><b>Detect/Undetected</b> Displays whether PGM2 audio RX is being received.</p> <p><b>Sampling rate</b> Displays the sampling rate of the received PGM2 audio RX.</p> <p><b>Payload type</b> Displays the payload type of the received PGM2 audio RX.</p>
<b>INCOM1 format</b>	<p><b>Detect/Undetected</b> Displays whether INCOM1 audio RX is being received.</p> <p><b>Sampling rate</b> Displays the sampling rate of the received INCOM1 audio RX.</p> <p><b>Payload type</b> Displays the payload type of the received INCOM1 audio RX.</p>
<b>INCOM2 format</b>	<p><b>Detect/Undetected</b> Displays whether INCOM2 audio RX is being received.</p> <p><b>Sampling rate</b> Displays the sampling rate of the received INCOM2 audio RX.</p> <p><b>Payload type</b> Displays the payload type of the received INCOM2 audio RX.</p>

## Network settings screen [Network]

Make settings related to the network for AK-NP600 in the Network settings screen [Network].

The Network settings screen [Network] consists of [SFP+ primary], [SFP+ primary TX], [SFP+ primary RX], [SFP+ secondary], [SFP+ secondary TX], [SFP+ secondary RX], [1GbE], [Tally in setting], [PTP setting], [NMOS setting], and [Common].

### SFP+ primary

Click [SFP+ primary] in the Network settings screen [Network].

Make network settings for the [SFP+1] slot (SFP+ primary) for MoIP input/output.

Confirm the settings with the [Set] button.

The following information is required to configure network settings. Consult your network administrator or Internet service provider.

- IP address
- Port
- Subnet mask
- Default gateway (when using a gateway server or router)

\_\_\_ indicates factory default settings.

Item	Setting value	Setting details
<b>DHCP</b>	ON OFF	Select the method for setting the SFP+ primary IP addresses.
<b>IP address</b>	<u>192.168.0.50</u>	When not using the DHCP function, enter the SFP+ primary IP addresses. Enter so that the address does not duplicate the IP addresses of the personal computer or other network cameras.
<b>Port</b>	<u>49300</u> (1024 to 50000)	Enter the SFP+ primary port numbers.
<b>Subnet mask</b>	<u>255.255.255.0</u>	When not using the DHCP function, enter the SFP+ primary subnet masks.
<b>Default gateway</b>	<u>192.168.0.1</u>	When not using the DHCP function, set the SFP+ primary default gateways.
<b>Mac address</b>	Display only	Display the SFP+ primary MAC addresses.

## SFP+ primary TX

Click [SFP+ primary TX] in the Network settings screen [Network].

Make network settings for the SFP+ primary TX signal.

Confirm the settings with the [Set] button.

\_\_\_ indicates factory default settings.

Item	Setting value	Setting details
<b>Main video TX</b>	<ul style="list-style-type: none"> <li>IP address <u>224.1.0.1</u></li> <li>Port <u>49301</u> (1024 to 50000, 10670 is prohibited)</li> </ul>	<p><b>IP address</b> Enter the IP address for Main video TX.</p> <p><b>Port</b> Enter the port number for Main video TX.</p>
<b>Monitor video TX</b>	<ul style="list-style-type: none"> <li>IP address <u>224.1.0.2</u></li> <li>Port <u>49302</u> (1024 to 50000, 10670 is prohibited)</li> </ul>	<p><b>IP address</b> Enter the IP address for Monitor video TX.</p> <p><b>Port</b> Enter the port number for Monitor video TX.</p>
<b>HD trunk TX</b>	<ul style="list-style-type: none"> <li>IP address <u>224.1.0.10</u></li> <li>Port <u>49310</u> (1024 to 50000, 10670 is prohibited)</li> </ul>	<p><b>IP address</b> Enter the IP address for HD trunk TX.</p> <p><b>Port</b> Enter the port number for HD trunk TX.</p>
<b>MIC1 audio TX</b>	<ul style="list-style-type: none"> <li>IP address <u>224.1.0.3</u></li> <li>Port <u>49303</u> (1024 to 50000, 10670 is prohibited)</li> </ul>	<p><b>IP address</b> Enter the IP address for MIC1 audio TX.</p> <p><b>Port</b> Enter the port number for MIC1 audio TX.</p>
<b>MIC2 audio TX</b>	<ul style="list-style-type: none"> <li>IP address <u>224.1.0.11</u></li> <li>Port <u>49311</u> (1024 to 50000, 10670 is prohibited)</li> </ul>	<p><b>IP address</b> Enter the IP address for MIC2 audio TX.</p> <p><b>Port</b> Enter the port number for MIC2 audio TX.</p>

Item	Setting value	Setting details
<b>INCOM1 audio TX</b>	<ul style="list-style-type: none"> <li>IP address <u>224.1.0.12</u></li> <li>Port <u>49312</u> (1024 to 50000, 10670 is prohibited)</li> </ul>	<p><b>IP address</b> Enter the IP address for INCOM1 audio TX.</p> <p><b>Port</b> Enter the port number for INCOM1 audio TX.</p>
<b>INCOM2 audio TX</b>	<ul style="list-style-type: none"> <li>IP address <u>224.1.0.13</u></li> <li>Port <u>49313</u> (1024 to 50000, 10670 is prohibited)</li> </ul>	<p><b>IP address</b> Enter the IP address for INCOM2 audio TX.</p> <p><b>Port</b> Enter the port number for INCOM2 audio TX.</p>

### SFP+ primary RX

Click [SFP+ primary RX] in the Network settings screen [Network].

Make network settings for the SFP+ primary RX signal.

Confirm the settings with the [Set] button.

\_\_\_ indicates factory default settings.

Item	Setting value	Setting details
<b>Return video RX</b>	<ul style="list-style-type: none"> <li>Multicast address <u>224.1.0.4</u></li> <li>Source address <u>0.0.0.0</u></li> <li>Port <u>49304</u> (1024 to 50000, 10670 is prohibited)</li> </ul>	<p><b>Multicast address</b> Enter the multicast address for return images.</p> <p><b>Source address</b> Enter the source IP address for return images.</p> <p><b>Port</b> Enter the port number for return images.</p>
<b>HD prompter RX</b>	<ul style="list-style-type: none"> <li>Multicast address <u>224.1.0.14</u></li> <li>Source address <u>0.0.0.0</u></li> <li>Port <u>49314</u> (1024 to 50000, 10670 is prohibited)</li> </ul>	<p><b>Multicast address</b> Enter the multicast address for HD PROMPTER RX.</p> <p><b>Source address</b> Enter the source IP address for HD PROMPTER RX.</p> <p><b>Port</b> Enter the port number for HD PROMPTER RX.</p>

Item	Setting value	Setting details
PGM1 audio RX	<ul style="list-style-type: none"> <li>• Multicast address <u>224.1.0.16</u></li> <li>• Source address <u>0.0.0.0</u></li> <li>• Port <u>49316</u> (1024 to 50000, 10670 is prohibited)</li> </ul>	<p><b>Multicast address</b> Enter the multicast address for PGM1 audio RX.</p> <p><b>Source address</b> Enter the source IP address for PGM1 audio RX.</p> <p><b>Port</b> Enter the port number for PGM1 audio RX.</p>
PGM2 audio RX	<ul style="list-style-type: none"> <li>• Multicast address <u>224.1.0.17</u></li> <li>• Source address <u>0.0.0.0</u></li> <li>• Port <u>49317</u> (1024 to 50000, 10670 is prohibited)</li> </ul>	<p><b>Multicast address</b> Enter the multicast address for PGM2 audio RX.</p> <p><b>Source address</b> Enter the source IP address for PGM2 audio RX.</p> <p><b>Port</b> Enter the port number for PGM2 audio RX.</p>
INCOM1 audio RX	<ul style="list-style-type: none"> <li>• Multicast address <u>224.1.0.18</u></li> <li>• Source address <u>0.0.0.0</u></li> <li>• Port <u>49318</u> (1024 to 50000, 10670 is prohibited)</li> </ul>	<p><b>Multicast address</b> Enter the multicast address for INCOM1 audio RX.</p> <p><b>Source address</b> Enter the source IP address for INCOM1 audio RX.</p> <p><b>Port</b> Enter the port number for INCOM1 audio RX.</p>
INCOM2 audio RX	<ul style="list-style-type: none"> <li>• Multicast address <u>224.1.0.19</u></li> <li>• Source address <u>0.0.0.0</u></li> <li>• Port <u>49319</u> (1024 to 50000, 10670 is prohibited)</li> </ul>	<p><b>Multicast address</b> Enter the multicast address for INCOM2 audio RX.</p> <p><b>Source address</b> Enter the source IP address for INCOM2 audio RX.</p> <p><b>Port</b> Enter the port number for INCOM2 audio RX.</p>

## SFP+ secondary

Click [SFP+ secondary] in the Network settings screen [Network].

Make network settings for the [SFP+2] slot (SFP+ secondary) for MoIP input/output.

Confirm the settings with the [Set] button.

The following information is required to configure network settings. Consult your network administrator or Internet service provider.

- IP address
- Port
- Subnet mask
- Default gateway (when using a gateway server or router)

\_\_\_ indicates factory default settings.

Item	Setting value	Setting details
<b>DHCP</b>	ON OFF	Select the method for setting the SFP+ secondary IP addresses.
<b>IP address</b>	<u>192.168.0.51</u>	When not using the DHCP function, enter the SFP+ secondary IP addresses. Enter so that the address does not duplicate the IP addresses of the personal computer or other network cameras.
<b>Port</b>	<u>49309</u> (49300 to 49999)	Enter the SFP+ secondary port numbers.
<b>Subnet mask</b>	<u>255.255.255.0</u>	When not using the DHCP function, enter the SFP+ secondary subnet masks.
<b>Default gateway</b>	<u>192.168.0.1</u>	When not using the DHCP function, set the SFP+ secondary default gateways.
<b>Mac address</b>	Display only	Display the SFP+ secondary MAC addresses.

## SFP+ secondary TX

Click [SFP+ secondary TX] in the Network settings screen [Network].

Make network settings for the SFP+ secondary TX signal.

Confirm the settings with the [Set] button.

\_\_\_ indicates factory default settings.

Item	Setting value	Setting details
<b>Main video TX</b>	<ul style="list-style-type: none"> <li>IP address <u>224.1.0.5</u></li> <li>Port <u>49305</u> (1024 to 50000, 10670 is prohibited)</li> </ul>	<p><b>IP address</b> Enter the IP address for Main video TX.</p> <p><b>Port</b> Enter the port number for Main video TX.</p>
<b>Monitor video TX</b>	<ul style="list-style-type: none"> <li>IP address <u>224.1.0.6</u></li> <li>Port <u>49306</u> (1024 to 50000, 10670 is prohibited)</li> </ul>	<p><b>IP address</b> Enter the IP address for Monitor video TX.</p> <p><b>Port</b> Enter the port number for Monitor video TX.</p>
<b>HD trunk TX</b>	<ul style="list-style-type: none"> <li>IP address <u>224.1.0.20</u></li> <li>Port <u>49320</u> (1024 to 50000, 10670 is prohibited)</li> </ul>	<p><b>IP address</b> Enter the IP address for HD trunk TX.</p> <p><b>Port</b> Enter the port number for HD trunk TX.</p>
<b>MIC1 audio TX</b>	<ul style="list-style-type: none"> <li>IP address <u>224.1.0.7</u></li> <li>Port <u>49307</u> (1024 to 50000, 10670 is prohibited)</li> </ul>	<p><b>IP address</b> Enter the IP address for MIC1 audio TX.</p> <p><b>Port</b> Enter the port number for MIC1 audio TX.</p>
<b>MIC2 audio TX</b>	<ul style="list-style-type: none"> <li>IP address <u>224.1.0.21</u></li> <li>Port <u>49321</u> (1024 to 50000, 10670 is prohibited)</li> </ul>	<p><b>IP address</b> Enter the IP address for MIC2 audio TX.</p> <p><b>Port</b> Enter the port number for MIC2 audio TX.</p>

Item	Setting value	Setting details
<b>INCOM1 audio TX</b>	<ul style="list-style-type: none"> <li>IP address <u>224.1.0.22</u></li> <li>Port <u>49322</u> (1024 to 50000, 10670 is prohibited)</li> </ul>	<p><b>IP address</b> Enter the source IP address for INCOM1 audio TX.</p> <p><b>Port</b> Enter the port number for INCOM1 audio TX.</p>
<b>INCOM2 audio TX</b>	<ul style="list-style-type: none"> <li>IP address <u>224.1.0.23</u></li> <li>Port <u>49323</u> (1024 to 50000, 10670 is prohibited)</li> </ul>	<p><b>IP address</b> Enter the source IP address for INCOM2 audio TX.</p> <p><b>Port</b> Enter the port number for INCOM2 audio TX.</p>

### SFP+ secondary RX

Click [SFP+ secondary RX] in the Network settings screen [Network].

Make network settings for the SFP+ secondary RX signal.

Confirm the settings with the [Set] button.

SFP+ secondary RX

Return video RX

Multicast address

Source address

Port  (1024 - 50000, 10670 \*)

HD prompter RX

Multicast address

Source address

Port  (1024 - 50000, 10670 \*)

PGM1 audio RX

Multicast address

Source address

Port  (1024 - 50000, 10670 \*)

PGM2 audio RX

Multicast address

Source address

Port  (1024 - 50000, 10670 \*)

INCOM1 audio RX

Multicast address

\_\_\_ indicates factory default settings.

Item	Setting value	Setting details
<b>Return video RX</b>	<ul style="list-style-type: none"> <li>Multicast address <u>224.1.0.8</u></li> <li>Source address <u>0.0.0.0</u></li> <li>Port <u>49308</u> (1024 to 50000, 10670 is prohibited)</li> </ul>	<p><b>Multicast address</b> Enter the multicast address for return images.</p> <p><b>Source address</b> Enter the source IP address for return images.</p> <p><b>Port</b> Enter the port number for return images.</p>
<b>HD prompter RX</b>	<ul style="list-style-type: none"> <li>Multicast address <u>224.1.0.24</u></li> <li>Source address <u>0.0.0.0</u></li> <li>Port <u>49324</u> (1024 to 50000, 10670 is prohibited)</li> </ul>	<p><b>Multicast address</b> Enter the multicast address for HD PROMPTER RX.</p> <p><b>Source address</b> Enter the source IP address for HD PROMPTER RX.</p> <p><b>Port</b> Enter the port number for HD PROMPTER RX.</p>



Item	Setting value	Setting details
<b>PGM1 audio RX</b>	<ul style="list-style-type: none"> <li>• Multicast address <u>224.1.0.26</u></li> <li>• Source address <u>0.0.0.0</u></li> <li>• Port <u>49326</u> (1024 to 50000, 10670 is prohibited)</li> </ul>	<p><b>Multicast address</b> Enter the multicast address for PGM1 audio RX.</p> <p><b>Source address</b> Enter the source IP address for PGM1 audio RX.</p> <p><b>Port</b> Enter the port number for PGM1 audio RX.</p>
<b>PGM2 audio RX</b>	<ul style="list-style-type: none"> <li>• Multicast address <u>224.1.0.27</u></li> <li>• Source address <u>0.0.0.0</u></li> <li>• Port <u>49327</u> (1024 to 50000, 10670 is prohibited)</li> </ul>	<p><b>Multicast address</b> Enter the multicast address for PGM2 audio RX.</p> <p><b>Source address</b> Enter the source IP address for PGM2 audio RX.</p> <p><b>Port</b> Enter the port number for PGM2 audio RX.</p>
<b>INCOM1 audio RX</b>	<ul style="list-style-type: none"> <li>• Multicast address <u>224.1.0.28</u></li> <li>• Source address <u>0.0.0.0</u></li> <li>• Port <u>49328</u> (1024 to 50000, 10670 is prohibited)</li> </ul>	<p><b>Multicast address</b> Enter the multicast address for INCOM1 audio RX.</p> <p><b>Source address</b> Enter the source IP address for INCOM1 audio RX.</p> <p><b>Port</b> Enter the port number for INCOM1 audio RX.</p>
<b>INCOM2 audio RX</b>	<ul style="list-style-type: none"> <li>• Multicast address <u>224.1.0.29</u></li> <li>• Source address <u>0.0.0.0</u></li> <li>• Port <u>49329</u> (1024 to 50000, 10670 is prohibited)</li> </ul>	<p><b>Multicast address</b> Enter the multicast address for INCOM2 audio RX.</p> <p><b>Source address</b> Enter the source IP address for INCOM2 audio RX.</p> <p><b>Port</b> Enter the port number for INCOM2 audio RX.</p>

## 1GbE

Click [1GbE] in the Network settings screen [Network].

Make network settings for the 1GbE (LAN2) for AK-NP600.

Confirm the settings with the [Set] button.

The following information is required to configure network settings. Consult your network administrator or Internet service provider.

- IP address
- Port
- Subnet mask
- Default gateway (when using a gateway server or router)
- Primary server address, secondary server address, and domain for DNS (when using DNS)

\_\_\_ indicates factory default settings.

Item	Setting value	Setting details
<b>DHCP</b>	ON OFF	Select the method for setting the 1GbE (LAN2) IP addresses.
<b>IP address</b>	<u>192.168.0.52</u>	When not using the DHCP function, enter the 1GbE (LAN2) IP addresses. Enter so that the address does not duplicate the IP addresses of the personal computer or other network cameras.
<b>Port</b>	<u>49300</u> (1024 to 50000)	Enter the 1GbE (LAN2) port numbers.
<b>Subnet mask</b>	<u>255.255.255.0</u>	When not using the DHCP function, enter the 1GbE (LAN2) subnet masks.
<b>Default gateway</b>	<u>192.168.0.1</u>	When not using the DHCP function, set the 1GbE (LAN2) default gateways.
<b>Mac address</b>	Display only	Display the 1GbE (LAN2) MAC addresses.
<b>DNS</b>	<ul style="list-style-type: none"> <li>• DNS <u>MANUAL</u> AUTO</li> <li>• Primary server address <u>0.0.0.0</u></li> <li>• Secondary server address <u>0.0.0.0</u></li> <li>• Domain The default value is blank</li> </ul>	<p><b>DNS</b> Sets whether the DNS server address is to be acquired automatically (AUTO), or to be input manually (MANUAL).</p> <p><b>Primary server address</b> <b>Secondary server address</b> <b>Domain</b> When using [MANUAL] for [DNS], enter the IP address for the DNS server.</p> <ul style="list-style-type: none"> <li>• Consult the system administrator regarding the DNS server information.</li> </ul>

## Tally in setting

Click [Tally in setting] in the Network settings screen [Network].

Make settings related to Tally control via TSL Protocol 5.0.

Confirm the settings with the [Set] button.

\_\_\_ indicates factory default settings.

Item	Setting value	Setting details
Index no.	<u>1</u> (1 to 65534)	Enter the Index no. set by devices that output Tally.
Port	<u>62000</u> (60000 to 65535)	Enter the Tally in port number.

### NOTE

- The IP address of Tally in becomes the setting of the connected IP network.

Ex.: When input from SFP+ primary

The SFP+ Primary IP address is enabled

## PTP setting

Click [PTP setting] in the Network settings screen [Network].

Make PTP related network settings.

Confirm the settings with the [Set] button.

\_\_\_ indicates factory default settings.

Item	Setting value	Setting details
Domain	<u>127</u> (0 to 127)	Sets the DOMAIN number.
IP address	Display only	Displays the IP address automatically discovered.

## NMOS setting

Click [NMOS setting] in the Network settings screen [Network].

Make NMOS related network settings.

Confirm the settings with the [Set] button.

The screenshot shows the 'NMOS setting' screen with the following configuration:

- NMOS control:** On (radio button selected)
- Status:** REGISTERD
- Port (IS-04):** 50040 (range 1024 - 65535)
- Port (IS-05):** 50050 (range 1024 - 65535)
- RDS IP address:** 192.168.0.129
- RDS port:** 50060
- Label setting:** Manual (radio button selected)
- Label prefix:** X000000X
- Discovery:** uniDNS (radio button selected)

A 'Set' button is located at the bottom center of the screen.

\_\_\_ indicates factory default settings.

Item	Setting value	Setting details
<b>NMOS control</b>	<u>ON</u> OFF	Enables/disables the NMOS function.
<b>Status</b>	UNREGISTERD REGISTERING REGISTERED P2P MODE (Display only)	Displays the NMOS operation status, such as RDS connection status.
<b>Port(IS-04)</b>	<u>50040</u> (1024 to 65535)	Sets the port number on the camera for IS-04 Node API.
<b>Port(IS-05)</b>	<u>50050</u> (1024 to 65535)	Sets the port number on the camera for IS-05 Node API.
<b>RDS IP address</b>	Display only	Displays the discovered IP address.
<b>RDS port</b>	Display only	Displays the port number automatically discovered.
<b>Label setting</b>	<u>AUTO</u> MANUAL	<b>AUTO</b> The Label prefix cannot be changed. It is fixed to UCU600_**** (**** is the last four digits of the Mac address). <b>MANUAL</b> Text can be set in Label prefix.
<b>Label prefix</b>	UCU600_**** (**** is the last four digits of the Mac address)	Sets the prefix appended which is shared with NMOS resource names on this unit.
<b>Discovery</b>	<u>uniDNS</u> mDNS	Sets the method for NMOS resource discovery.

## Common

Click [Common] in the Network settings screen [Network].

Make AK-NP600 shared network settings.

Confirm the settings with the [Set] button.

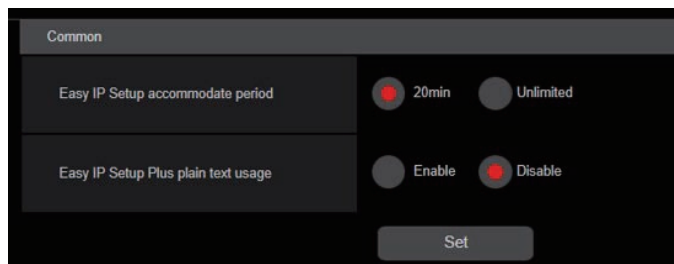

\_\_\_ indicates factory default settings.

Item	Setting value	Setting details
<b>EasyIP Setup accommodate period</b>	<u>20min.</u> Unlimited	Sets the time allowed for network setting operations from EasyIP Setup Tool Plus. <b>20min.</b> Allows camera setting operations on the EasyIP Setup Tool Plus for just 20 minutes after start up of this unit. <b>Unlimited</b> Allows camera setting operations on the EasyIP Setup Tool Plus at any time. <ul style="list-style-type: none"> <li>• Camera display on the EasyIP Setup Tool Plus is enabled all the time, and the camera screen can be opened.</li> <li>• Consult the network administrator regarding the address settings for the different servers.</li> </ul>
<b>EasyIP Setup Plus plain text usage</b>	Enable <u>Disable</u>	Sets whether to enable or disable encryption of communications when communicating with EasyIP Setup Tool Plus. <b>Enable</b> Communications are sent and received as plain messages. <b>Disable</b> Communications are sent and received as encrypted messages.

## User management screen [User mng.]

In the User management screen [User mng.], register authentication for users that can access this unit from personal computers and mobile terminals. Up to 3 users can be registered.

The User management screen [User mng.] consists of [User list] and [Add user].

### NOTE

- If user authentication fails more than 8 times within a 30-second period from the same IP address (personal computer), access to the unit will be disabled for a certain period.

## User list

Click [User list] in the User management screen [User mng.].

Information about accounts already registered is displayed.

To delete a registered user account, click the [Delete] button to the right of the relevant account.

User list	User Name	Password	
1.	user1	*****	Delete
2.	user2	*****	Delete
3.	user3	*****	Delete

### NOTE

- If there is 1 registered account, you cannot delete that account.

## Add user

Registers a user account.

Add user	
User name	<input type="text"/>
Password	<input type="password"/>
Retype password	<input type="password"/>
Set	

Item	Setting details
<b>User name</b>	Enter the user name. <ul style="list-style-type: none"> <li>• Maximum number of characters 1 to 32 half-size characters</li> <li>• Characters that can be entered               <ul style="list-style-type: none"> <li>• Half-size numeric characters: 0123456789</li> <li>• Half-size alphabetical characters (upper and lower cases): ABCDEFGHIJKLMNOPQRSTUVWXYZ abcdefghijklmnopqrstuvwxyz</li> <li>• Symbols: !#\$%&amp;'()*+,-./?:@[]^_`~</li> </ul> </li> </ul>
<b>Password</b> <b>Retype password</b>	Enter the password. <ul style="list-style-type: none"> <li>• Maximum number of characters 4 to 32 half-size characters</li> </ul>

# Troubleshooting

## Operation

Symptom	Cause and Measure
Cannot turn the power on.	<ul style="list-style-type: none"> <li>Is the power cable connected to the outlet properly?</li> </ul>
Cannot perform operation from an ROP connected with an IP connection.	<ul style="list-style-type: none"> <li>Is the power on?                             <ul style="list-style-type: none"> <li>If the [POWER] lamp of this unit is off, the power of this unit is not turned on.</li> </ul> </li> <li>Is a valid IP address set on the unit?</li> <li>Is the unit you want to operate selected correctly?</li> <li>Is the ROP connected correctly?                             <ul style="list-style-type: none"> <li>Also refer to the operating instructions for the ROP.</li> </ul> </li> <li>The version of the ROP may need to be upgraded to enable support for the unit.                             <ul style="list-style-type: none"> <li>Consult your dealer.</li> </ul> </li> </ul>
Cannot access from a web browser	<ul style="list-style-type: none"> <li>Did you use a LAN cable of category 5 or higher for connecting to the [LAN] connector?</li> <li>Is the [LINK] LED of the [LAN] connector lit?                             <ul style="list-style-type: none"> <li>If it is not lit, the unit is not connected to the LAN properly or the network of the connection destination is not operating properly. Check the LAN cable for a bad electrical contact and make sure the connections are correct.</li> </ul> </li> <li>Is the power on?                             <ul style="list-style-type: none"> <li>If the [POWER] lamp of this unit is off, the power of this unit is not turned on.</li> </ul> </li> <li>Is a valid IP address set on the unit?</li> <li>Is the wrong IP address being accessed? (Windows)                             <ul style="list-style-type: none"> <li>Using the Windows command prompt, execute &gt; ping [IP address which has been set in this unit] A reply returned from the unit signifies that there are no problems in operation. If a reply is not received, reboot the unit, and within 20 minutes change the IP address using the Easy IP Setup Software.</li> </ul> </li> <li>Is the wrong IP address being accessed? (Mac)                             <ul style="list-style-type: none"> <li>Using the OS X terminal, execute &gt; ping -c 10 [IP address which has been set in this unit] A reply returned from the unit signifies that there are no problems in operation. If a reply is not received, reboot the unit, and within 20 minutes change the IP address using the Easy IP Setup Software.</li> </ul> </li> <li>Has 554 been set as the HTTP port number?                             <ul style="list-style-type: none"> <li>For the HTTP port number, use a port number other than the following port numbers that are used by the unit. 20, 21, 23, 25, 42, 53, 67, 68, 69, 110, 123, 161, 162, 554, 995, 10669, 10670, 59000 to 59999, 60000 to 61000</li> </ul> </li> <li>Is the set IP address the same as that of another device?                             <ul style="list-style-type: none"> <li>Check out the IP addresses of the unit, access devices (personal computer, controller, etc.) and any other cameras.</li> </ul> </li> <li>Does the subnet mask setting match the network subnet of the connection destination?                             <ul style="list-style-type: none"> <li>Check out the subnet mask settings of the unit and access devices, and then consult with the network administrator.</li> </ul> </li> <li>Is the Web browser set to "Use a proxy server"? (When the unit and the personal computer are connected to the same subnet)                             <ul style="list-style-type: none"> <li>If a proxy server has been set using the [proxy setting] of the web browser, it is recommended that a "Don't use proxy" address be selected as the unit's IP address setting.</li> </ul> </li> <li>Has the wrong default gateway been set for the unit? (When the unit and personal computer are connected to different subnets)                             <ul style="list-style-type: none"> <li>Check out the default gateway that has been set for the unit, and then consult with the network administrator.</li> </ul> </li> </ul>

Symptom	Cause and Measure
<p>The setting values of the [Setup] screen are not updated properly or are not displayed.</p>	<ul style="list-style-type: none"> <li>● <b>Press the [F5] key on the personal computer keyboard to request the setting values to be obtained. (Windows)</b></li> <li>● <b>Press the [Command] + [R] key on the personal computer keyboard to request the setting values to be obtained. (Mac)</b></li> <li>● <b>Delete the temporary Internet files as described below. (Mac)</b> <ol style="list-style-type: none"> <li>1. Select [Safari] - [Empty Cache] in Safari.</li> <li>2. Click the [Delete] button under [Browsing history].</li> </ol> </li> <li>● <b>Delete the temporary Internet files as described below. (Windows)</b> <ol style="list-style-type: none"> <li>1. Select [Tools] - [Internet Options] in Internet Explorer.</li> <li>2. Click [Empty] in the [Are you sure you want to empty the cache?] pop-up screen.</li> </ol> </li> <li>● <b>If [Check for newer versions of stored pages] is not set to [Every time I visit the webpage] in the temporary Internet file settings, the Web settings screen may not be displayed properly. (Windows)</b> <ul style="list-style-type: none"> <li>● Perform the procedure below.                             <ol style="list-style-type: none"> <li>1. Select [Tools] - [Internet Options] in Internet Explorer.</li> <li>2. Click the [General] tab, and click the [Settings] button under [Browsing history].</li> <li>3. In the [Temporary Internet Files and History Settings] dialog box, select the [Every time I visit the webpage] option under [Check for newer versions of stored pages].</li> <li>4. Click the [OK] button.</li> </ol> </li> </ul> </li> <li>● <b>A port of the unit may be being filtered by, for example, the firewall function of the antivirus software.</b> <ul style="list-style-type: none"> <li>● Change the HTTP port number of the unit to a port number that is not filtered.</li> </ul> </li> </ul>
<p>It is not possible to download the setting files</p>	<ul style="list-style-type: none"> <li>● <b>Has the file download function been disabled? (Windows)</b> <ul style="list-style-type: none"> <li>● Perform the procedure below.                             <ol style="list-style-type: none"> <li>1. Select [Tools] - [Internet Options] in Internet Explorer.</li> <li>2. Click the [Security] tab, and click the [Custom level] button under [Security level for this zone].</li> <li>3. In the [Security Settings] dialog box, select the [Enable] option for [File download].</li> <li>4. Select the [Enable] option for [Automatic prompting for the file downloads]. (for Internet Explorer 8 only)</li> <li>5. Click the [OK] button.</li> <li>6. Click the [OK] button.</li> </ol> </li> </ul> </li> </ul>
<p>The authentication screen appears repeatedly</p>	<ul style="list-style-type: none"> <li>● <b>Has the user name or password been changed?</b> <ul style="list-style-type: none"> <li>● If you change the user name and password of the user currently logged in from a separate web browser while the unit is being accessed, the authentication screen appears each time the screen display is changed. Close the web browser, and initiate access to the unit again.</li> </ul> </li> <li>● <b>Has the method for user authentication been changed?</b> <ul style="list-style-type: none"> <li>● If you change the [User auth.] - [Authentication] setting, close the web browser and initiate access again.</li> </ul> </li> </ul>
<p>Screens displays take a while to appear</p>	<ul style="list-style-type: none"> <li>● <b>Is the unit on the same local network being accessed via proxy?</b> <ul style="list-style-type: none"> <li>● Configure the web browser settings so that access is not performed via proxy.</li> </ul> </li> <li>● <b>Are multiple users accessing the unit's IP images at the same time?</b> <ul style="list-style-type: none"> <li>● When multiple users access the unit's IP images at the same time, images may take some time to appear, and the frame rate of the IP images may decrease.</li> </ul> </li> </ul>



## IP Images

Symptom	Cause and Measure
Images are not displayed	<ul style="list-style-type: none"> <li>● <b>Is the plug-in viewer software installed? (Windows)</b> <ul style="list-style-type: none"> <li>● Install the plug-in viewer software.</li> </ul> </li> <li>● <b>If [Check for newer versions of stored pages] is not set to [Every time I visit the webpage] in the temporary Internet file settings, IP images may not appear in the [Live] screen.</b></li> <li>● Perform the procedure below.                             <ol style="list-style-type: none"> <li>1. Select [Tools] - [Internet Options] in Internet Explorer.</li> <li>2. Click the [General] tab, and click the [Settings] button under [Browsing history].</li> <li>3. In the [Temporary Internet Files and History Settings] dialog box, select the [Every time I visit the webpage] option under [Check for newer versions of stored pages].</li> <li>4. Click the [OK] button.</li> </ol> </li> <li>● IP image transmission is not possible in the following cases:                             <ul style="list-style-type: none"> <li>● When [CCU MODE] is [2160/23.98p], [2160/23.98psf], [1080/23.98p] or [1080/23.98psF]:</li> <li>● When the [SDI OUT5&amp;6] and [SDI OUT7] items in [OUT FORMAT(UHD)] or [OUT FORMAT(HD)] are [trueP]</li> <li>● When the [SDI OUT5&amp;6] and [SDI OUT7] items in [OUT FORMAT(UHD_HDR)] or [OUT FORMAT(HD_HDR)] are [trueP_HDR] or [trueP_SDR]</li> </ul> </li> </ul>
The images are blurry	<ul style="list-style-type: none"> <li>● <b>Is the focus properly adjusted?</b> <ul style="list-style-type: none"> <li>● Check the focus adjustment.</li> </ul> </li> </ul>
Images are not updated	<ul style="list-style-type: none"> <li>● <b>The images may not be updated and other problems may occur depending on your web browser and its version.</b></li> <li>● <b>The images may stop depending on the network congestion, the level of access to the unit, etc.</b></li> <li>● <b>If the IP video settings of the unit were changed, the image display may stop temporarily.</b> <ul style="list-style-type: none"> <li>● Check the state of access to the unit and stop unnecessary access. Afterward, press the [F5] key on the personal computer's keyboard to request the settings to be acquired. (Windows)</li> <li>● Check the state of access to the unit and stop unnecessary access. Afterward, press the [Command] + [R] keys on the personal computer's keyboard to request the settings to be acquired. (Mac)</li> </ul> </li> </ul>
The images do not update or display properly	<ul style="list-style-type: none"> <li>● <b>Perform the following to delete the temporary Internet files (cache). (Windows)</b> <ol style="list-style-type: none"> <li>1. Select [Tools] - [Internet Options] in Internet Explorer.</li> <li>2. Click the [General] tab, and click the [Delete] button under [Browsing history].</li> <li>3. In the [Delete Browsing History] screen, select the [Temporary Internet Files] checkbox, and then click [Delete].</li> <li>4. Click the [OK] button.</li> </ol> </li> <li>● <b>Perform the following to delete the temporary Internet files (cache). (Mac)</b> <ol style="list-style-type: none"> <li>1. Select [Safari] - [Empty Cache] in Safari.</li> <li>2. Click [Empty] in the [Are you sure you want to empty the cache?] pop-up screen.</li> </ol> </li> <li>● <b>A port of the unit may be being filtered by, for example, the firewall function of the antivirus software.</b> <ul style="list-style-type: none"> <li>● Change the HTTP port number of the unit to a port number that is not filtered.</li> </ul> </li> </ul>
H.264 images are not displayed	<ul style="list-style-type: none"> <li>● <b>If the "Network Camera View 4S" plug-in viewer software is deleted in an environment where the "Network Camera View 3" plug-in viewer software is installed, display of H.264 images will become impossible. In such cases, delete "Network Camera View 3" before installing "Network Camera View 4S".</b></li> <li>● <b>Is the camera connected to the personal computer via the Internet?</b> <ul style="list-style-type: none"> <li>● Set [Internet Mode(over HTTP)] to [On].</li> </ul> </li> </ul>
The images are distorted	<ul style="list-style-type: none"> <li>● <b>The images may be distorted if the transmission path is congested and proper transmission is not possible.</b> <ul style="list-style-type: none"> <li>● Consult your network administrator.</li> </ul> </li> <li>● <b>The images may be distorted if video packet shuffling occurs on the transmission path.</b> <ul style="list-style-type: none"> <li>● Switching to an identical Internet service provider for both the camera and the personal computer may prevent this problem. Consult your network administrator.</li> </ul> </li> </ul>

Symptom	Cause and Measure
<p><b>When multiple web browsers are running to display H.264 images, images from multiple cameras appear sequentially in a single web browser.</b></p>	<ul style="list-style-type: none"> <li>• <b>This may occur depending on the combination of the personal computer's display adapter and the driver. (Windows)</b> <ul style="list-style-type: none"> <li>• If this occurs, update the first display adapter to the latest version. If this does not resolve the problem, adjust the hardware accelerator function as follows. This section describes the procedure for Windows 7 as an example. Changing the settings may not be possible, depending on your environment.                             <ol style="list-style-type: none"> <li>1. Right-click on the desktop, and select [Screen Resolution] from the menu.</li> <li>2. Click [Advanced settings].</li> <li>3. Select the [Troubleshoot] tab, and click [Change setting].</li> <li>4. If the [User Account Control] dialog box appears, click [Yes]. (When logged on with an account other than an administrator account, enter the password (and user name if necessary), and click [Yes].)</li> <li>5. Change to [Hardware acceleration] setting to [None] at the far left, and click [OK].</li> </ol> </li> </ul> </li> </ul>

## Web Screen

Depending on the OS installed on the personal computer, the following may occur. If a problem occurs, take the corresponding measure. Performing the following solutions will not affect the operation of other applications.

The “information bar” described in the following explanations refers to the message bars that appear in Internet Explorer. (Windows)

- Internet Explorer  
The information bar appears at the bottom of Internet Explorer.



Symptom	Cause and Measure
For Internet Explorer 9.0, 10.0, and 11.0: The following message appears in the information bar. [This website wants to run the following add-on: 'WebVideo Module' from 'Panasonic System Networks Co.,Ltd.'.]	<ul style="list-style-type: none"> <li>• Select [Allow].</li> </ul>
For Internet Explorer 9.0, 10.0, and 11.0: The following message appears in the information bar. [This website wants to install the following add-on: 'nwcv4SSetup.exe' from 'Panasonic System Networks Co.,Ltd.'.]	<ul style="list-style-type: none"> <li>• Select [Install]. When the security warning window appears, click the [Install] button.</li> </ul>
An unnecessary status bar or scroll bar is displayed in the pop-up	<ul style="list-style-type: none"> <li>• Display the Security tab on the Internet Options screen of Internet Explorer, and then select [Internet]. Click the [Custom level] button, set [Allow script-initiated windows without size or position constraints] to [Enable] under [Miscellaneous], and click the [OK] button. When the warning window appears, click the [Yes] button.</li> </ul>
The IP images do not match the display frames	<ul style="list-style-type: none"> <li>• Images may not appear correctly if their DPI settings are 120 DPI or higher.                             <ul style="list-style-type: none"> <li>• Right-click on the desktop of the personal computer, click [Screen Resolution] - [Make text and other items larger or smaller], and select [Smaller - 100% (default)].</li> </ul> </li> <li>• Images may not appear correctly if the magnification level of Internet Explorer's zoom function is not set to 100%.                             <ul style="list-style-type: none"> <li>• Select [View] - [Zoom] in the menu bar of Internet Explorer, and click [100%].</li> </ul> </li> </ul>
The layout of the screen is distorted, or some buttons on the screen do not operate	<ul style="list-style-type: none"> <li>• Select [Tools] - [Compatibility View Settings] in the menu bar of Internet Explorer, disable compatibility view for the unit.</li> </ul>

# Reference

## Connector pin assignment table

### Front panel

#### [INTERCOM] connector (page 20: 5)

HA16PRH-5S (Hirose Electric Co., Ltd.)

Pin No.	Function	Remarks
1	SHIELD	Carbon MIC: -1 dB Dynamic MIC: -5 dB <ul style="list-style-type: none"> <li>Select [DYN] , [ECM], or [CBN] in [MIC TYPE] that can be accessed by selecting [CCU INTERCOM TALK] in the [AUDIO] menu.</li> </ul>
2	TALK	
3	SHIELD	
4	RECEIVE	
5	NC	

### Rear panel

#### [AUX] connector (page 25: 2)

JAY-15S-1A3F(LF)(SN) (J.S.T. Mfg. Co., Ltd.)

Pin No.	Function	Specifications	Remarks
1	TALLY YL OUT	Open collector output	➡ "Example of tally and alarm output connections" (see page 178)
2	P6	See remarks	When [AUX] > [FUNCTION] is set to [WFM_TYPE-A+SD_ASPECT] or [WFM_TYPE-B+SD_ASPECT] in the [MAINTENANCE] menu: <ul style="list-style-type: none"> <li>Waveform monitor preset setting bit output</li> <li>Open collector output</li> </ul> When [AUX] > [FUNCTION] is set to [AUDIO GAIN+SD_ASPECT] in the [MAINTENANCE] menu: <ul style="list-style-type: none"> <li>Camera microphone gain setting bit input</li> <li>Photo-coupler input</li> </ul>
3	P5		
4	P4		
5	P3		
6	P2		
7	P1		
8	GND		
9	MODE2	Photo-coupler input	➡ "Down-conversion mode settings" (see page 177)
10	MODE1	Photo-coupler input	➡ "Example of mode input connections" (see page 178)
11	GND	Ground	
12	ALARM	Open collector output	➡ "Example of tally and alarm output connections" (see page 178)
13	TALLY R OUT	Open collector output	➡ "Example of tally and alarm output connections" (see page 178)
14	TALLY G OUT	Open collector output	➡ "Example of tally and alarm output connections" (see page 178)
15	GND	Ground	

### Down-conversion mode settings

Down-conversion mode	MODE1	MODE2
Local	Open	Open
Letter box	Shorted	Open
Squeeze	Open	Shorted
Side panel	Shorted	Shorted

Shorted: Shorted with pin 8 (GND)

### Preset settings of waveform monitor

TYPE-A	AUX connector output					
	P6	P5	P4	P3	P2	P1
PRESET1	Shorted	Shorted	Shorted	Shorted	Shorted	Open
PRESET2	Shorted	Shorted	Shorted	Shorted	Open	Shorted
PRESET3	Shorted	Shorted	Shorted	Shorted	Open	Open
PRESET4	Shorted	Shorted	Shorted	Open	Shorted	Shorted
PRESET5	Shorted	Shorted	Shorted	Open	Shorted	Open
PRESET6	Shorted	Shorted	Shorted	Open	Open	Shorted

TYPE-B	AUX connector output					
	P6	P5	P4	P3	P2	P1
PRESET1	Open	Open	Open	Open	Open	Shorted
PRESET2	Open	Open	Open	Open	Shorted	Open
PRESET3	Open	Open	Open	Shorted	Open	Open
PRESET4	Open	Open	Shorted	Open	Open	Open
PRESET5	Open	Shorted	Open	Open	Open	Open
PRESET6	Shorted	Open	Open	Open	Open	Open

Shorted: Shorted with pin 8 (GND)

### AUDIO GAIN settings

You can control camera microphone gain from an external device.

Gain control setting	P1	P2
Disabled	Open	Open
MIC1 enabled	Shorted	Open
MIC2 enabled	Open	Shorted
MIC1 and MIC2 enabled	Shorted	Shorted

Camera microphone gain setting		Total gain	P3	P4	P5
MIC GAIN	AMP				
60	0	60 dB	Open	Open	Open
40	10	50 dB	Shorted	Open	Open
40	0	40 dB	Open	Shorted	Open
20	10	30 dB	Shorted	Shorted	Open
20	0	20 dB	Open	Open	Shorted

Shorted: Shorted with pin 8 (GND)

### Example of mode input connections

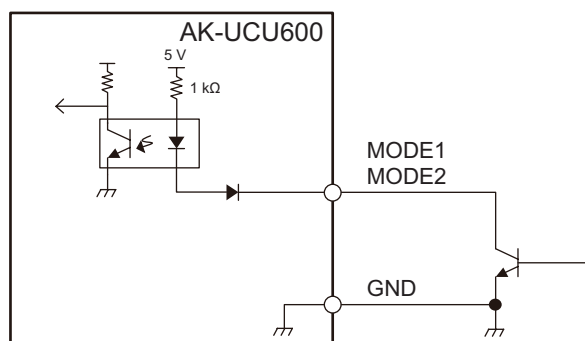

### Example of tally and alarm output connections

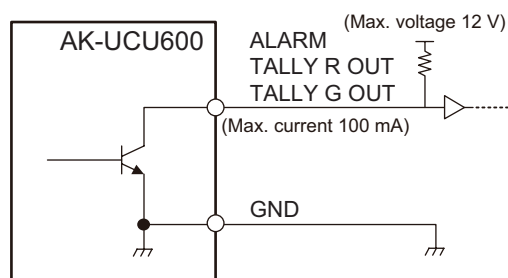
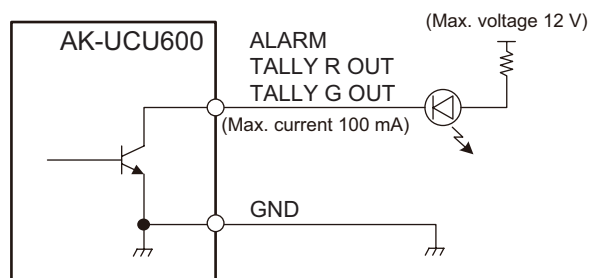

Withstand voltage: 12 V DC max.

Power current: 100 mA max.

### [TRUNK] connector (page 25: 3)

JEY-9S-1A3F (LF)(SN) (J.S.T. Mfg. Co., Ltd.)

Pin No.	Function	Flow of signal	Remarks
1	TRUNK1_TX (C)	CAM → CCU	<ul style="list-style-type: none"> <li>• RS-422 / RS-232C</li> <li>• Selected using a menu</li> <li>• Connect to the (C) side during RS-232C connections. The (H) is open.</li> </ul>
2	TRUNK1_TX (H)	CAM → CCU	
3	TRUNK1_RX (H)	CCU → CAM	
4	TRUNK1_RX (C)	CCU → CAM	
5	GND		
6	TRUNK2_TX (C)	CAM → CCU	
7	TRUNK2_TX (H)	CAM → CCU	
8	TRUNK2_RX (H)	CCU → CAM	
9	TRUNK2_RX (C)	CCU → CAM	

**[COMMUNICATION] connector (page 25: 4)**

JBY-25S-1A3F(LF)(SN) (J.S.T. Mfg. Co., Ltd.)

Pin No.	Function	Flow of signal	Remarks
1	INCOM ENG OUT (H)	CCU→SYSTEM	0 dBm, 600 Ω (4 W) / 1 V [p-p], 200 Ω (RTS) 4 W/RTS/CLRCOM ● Selected using a menu
2	INCOM ENG OUT (C)	CCU→SYSTEM	
3	INCOM ENG (GND)		
4	INCOM ENG IN (H)	SYSTEM→CCU	
5	INCOM ENG IN (C)	SYSTEM→CCU	
6	PGM IN (H)	SYSTEM→CCU	0 dBm/-20 dBm, 600 Ω ● Selected using a menu
7	PGM IN (C)	SYSTEM→CCU	
8	PGM IN (GND)		
9	GND		
10	NC		
11	R TALLY IN (H)	SYSTEM→CCU	<b>ON:</b> Short/TTL(H)/24 V ➔ "Example of tally input connections" (see page 180) <b>OFF:</b> Open/TTL(L)/0 V
12	R TALLY IN (C)	SYSTEM→CCU	
13	GND		
14	INCOM PROD OUT (H)	CCU→SYSTEM	0 dBm, 600 Ω (4 W) / 1 V [p-p], 200 Ω (RTS) 4 W/RTS/CLRCOM ● Selected using a menu
15	INCOM PROD OUT (C)	CCU→SYSTEM	
16	INCOM PROD (GND)		
17	INCOM PROD IN (H)	SYSTEM→CCU	
18	INCOM PROD IN (C)	SYSTEM→CCU	
19	PGM2 IN (H)	SYSTEM→CCU	0 dBm/-20 dBm, 600 Ω ● Selected using a menu
20	PGM2 IN (C)	SYSTEM→CCU	
21	PGM2 IN (GND)		
22	YL TALLY IN (H)	SYSTEM→CCU	<b>ON:</b> Short/TTL(H)/24 V ➔ "Example of tally input connections" (see page 180) <b>OFF:</b> Open/TTL(L)/0 V
23	YL TALLY IN (C)	SYSTEM→CCU	
24	G TALLY IN (H)	SYSTEM→CCU	
25	G TALLY IN (C)	SYSTEM→CCU	

### Example of tally input connections

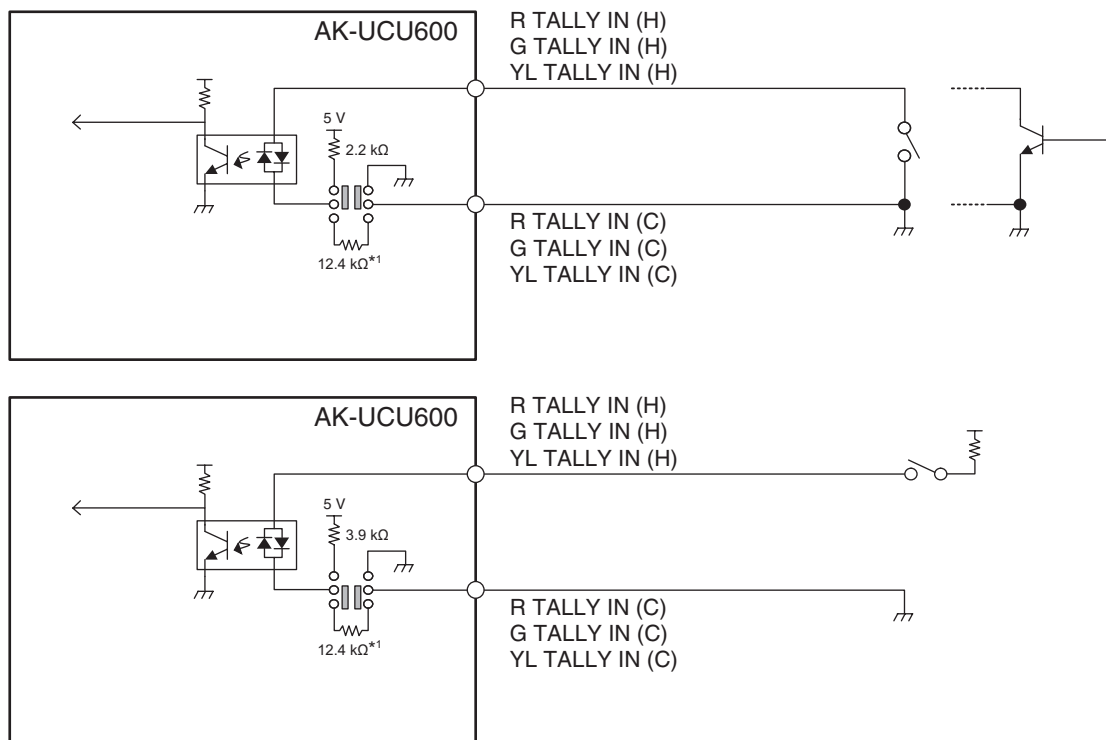

\*1: Equivalent circuit

### [ROP] connector (page 25: 5)

HR10G-10R-10SC (71) (Hirose Electric Co., Ltd.)

Pin No.	Function	Flow of signal
1	ROP CONT (H)	CCU→ROP
2	ROP CONT (C)	CCU→ROP
3	ROP DATA (H)	ROP→CCU
4	ROP DATA (C)	ROP→CCU
5	NC	
6	NC	
7	NC	
8	NC	
9	+16 V OUT	CCU→ROP
10	GND	

- Connector of cable

HR10A-10P-10P (73)

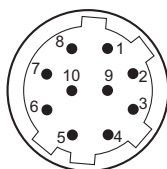



**[MSU] connector (page 25: 6)**

HR10G-10R-10SC (71) (Hirose Electric Co., Ltd.)

Pin No.	Function	Flow of signal
1	MSU CONT (H)	CCU→MSU
2	MSU CONT (C)	CCU→MSU
3	MSU DATA (H)	MSU→CCU
4	MSU DATA (C)	MSU→CCU
5	TALLY R	CCU→MSU
6	TALLY G	CCU→MSU
7	HEAD POWER	CCU→MSU
8	ALARM 1	CCU→MSU
9	ALARM 0	CCU→MSU
10	GND	

- Connector of cable  
HR10A-10P-10P (73)

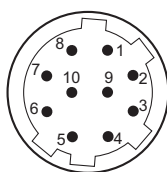
**[MIC1] and [MIC2] connectors (page 25: 7)**

HA16RV-3PG(76) (Hirose Electric Co., Ltd.)

Pin No.	Function	Flow of signal	Remarks
1	SHIELD		0 dBm, 600 Ω
2	HOT	CCU→SYSTEM	
3	COLD	CCU→SYSTEM	

- When connecting to an unbalanced input terminal of an external device, connect to it as shown in the diagram below.

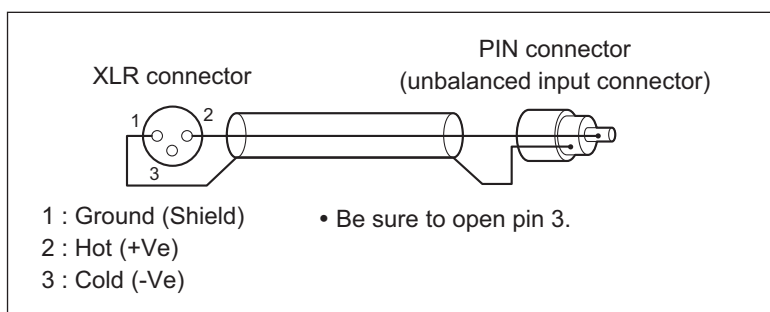

- Some commercially available conversion connectors and conversion cables have pin 3 shorted to pin 1. Using such a conversion connector or conversion cable will cause a failure.

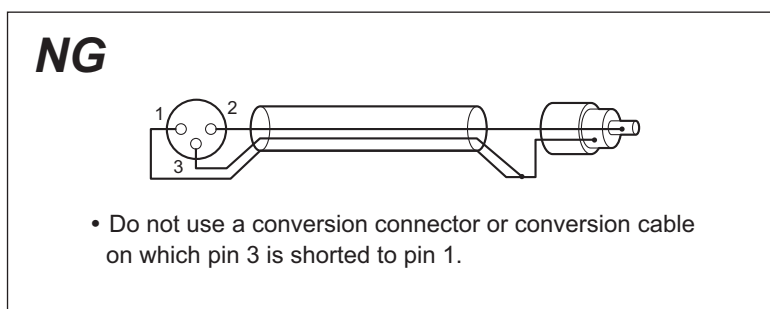

**[CAMERA] connector (page 25: 8)**

AK-UCU600: OPS2404-PR (Tajimi Electronics Co., Ltd.)

AK-UCU600S: FXW.3K.93C.TLM (LEMO)

Pin No.	Function	Flow of signal
1	Optical fiber	CAM → CCU
2	Optical fiber	CCU → CAM
3	Control line	CCU←→CAM
4	Control line	CCU←→CAM
5	AC 240 V	CCU → CAM
6	AC 240 V	CCU → CAM

## Front panel [G/L ON] indicator specifications

✓: Lit ×: Flashing -: Off

FORMAT/ CCU MODE	REF-IN							
	1080/59i	1080/23PsF	525/59i	720/59p	1080/50i	625/50i	720/50p	No input
<b>UHD/UHD_HDR(59.94)</b>								
2160/59.94p	✓	×	✓	×	×	×	×	-
2160/29.97p	✓	×	✓	×	×	×	×	-
2160/23.98p	×	✓	✓	×	×	×	×	-
2160/29.97PsF	✓	×	✓	×	×	×	×	-
2160/23.98PsF	×	✓	✓	×	×	×	×	-
2160/23PsF & over59i	×	✓	✓	×	×	×	×	-
<b>HD/HD_HDR(59.94)</b>								
1080/59.94p	✓	×	✓	×	×	×	×	-
1080/23.98p over 59.94i	✓	✓	✓	×	×	×	×	-
1080/29.97PsF	✓	×	✓	×	×	×	×	-
1080/23.98PsF	×	✓	✓	×	×	×	×	-
1080/23PsF & over59i	×	✓	✓	×	×	×	×	-
720/59.94p	×	×	✓	✓	×	×	×	-
<b>HS/HS_HDR(59.94)</b>								
1080/59.94p -(240fps/180fps/120fps)	✓	×	✓	×	×	×	×	-
720/59.94p -(240fps/180fps/120fps)	×	×	✓	✓	×	×	×	-
<b>UHD/UHD_HDR(50)</b>								
2160/50p	×	×	×	×	✓	✓	×	-
2160/25p	×	×	×	×	✓	✓	×	-
2160/25PsF	×	×	×	×	✓	✓	×	-
<b>HD/HD_HDR(50)</b>								
1080/50p	×	×	×	×	✓	✓	×	-
1080/25PsF	×	×	×	×	✓	✓	×	-
720/50p	×	×	×	×	×	✓	✓	-
<b>HS/HS_HDR(50)</b>								
1080/50p -(200fps/150fps/100fps)	×	×	×	×	✓	✓	×	-
720/50p -(200fps/150fps/100fps)	×	×	×	×	×	✓	✓	-

## Appearance

Unit: mm (inch)

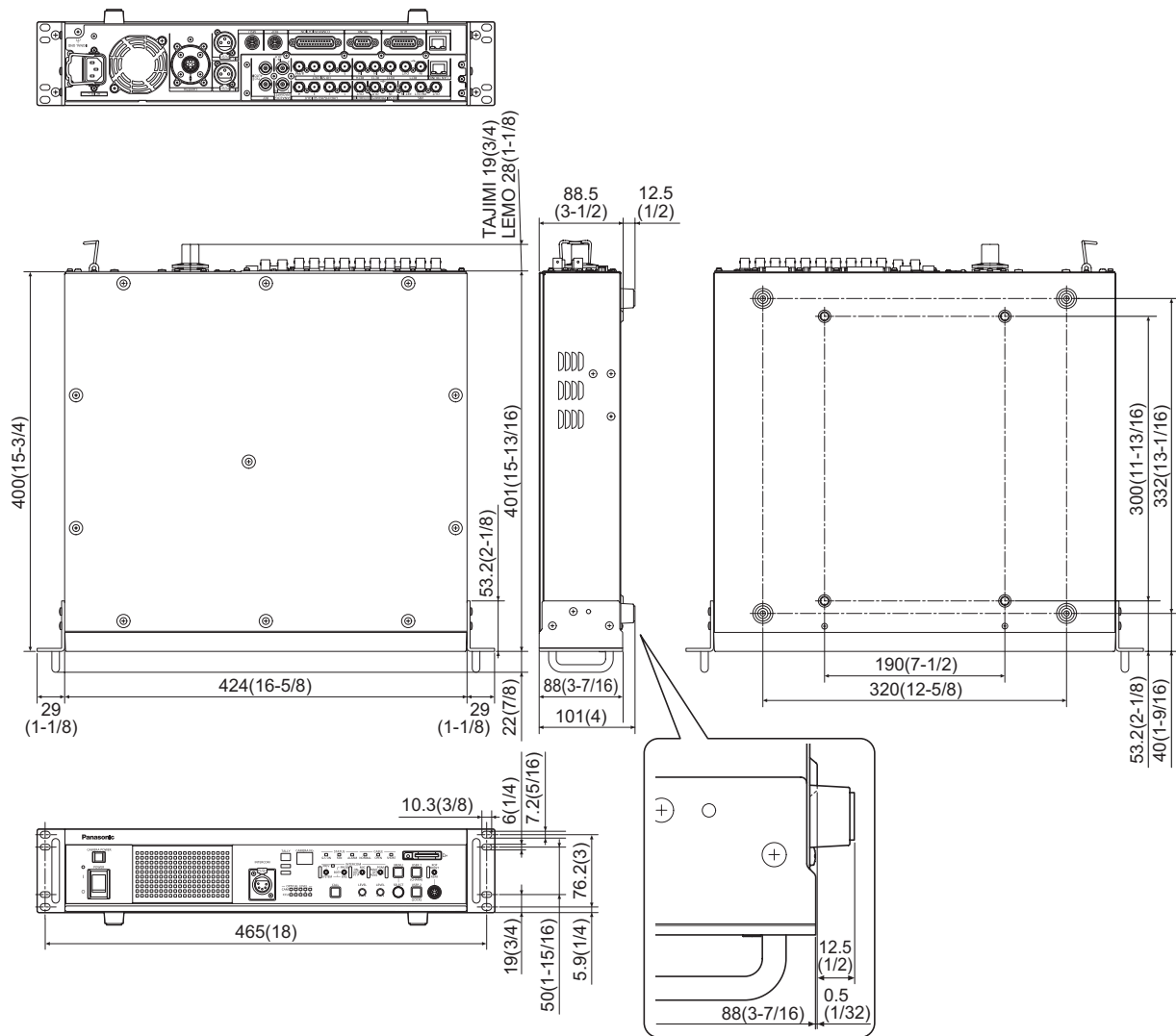

## Specifications

Power supply	AK-UCU600P/AK-UCU600PS : 100 V - 120 V AC (⌚), 50 Hz/60 Hz AK-UCU600E/AK-UCU600ES : 100 V - 240 V AC (⌚), 50 Hz/60 Hz
Power consumption	500 W (Without camera connected: 90 W)
Capacity for supplying power to a camera	240 V AC (⌚), 1.46 A , 50 Hz/60 Hz

 indicates safety information.

Operating temperature	0 °C to 40 °C (32 °F to 104 °F)
Humidity	10% to 90% (no condensation)
Dimensions (Width×Height×Depth)	424 mm × 88 mm × 401 mm (16-5/8 inches × 3-7/16 inches × 15-13/16 inches) (excluding protrusions)
Weight	Approx. 8.9 kg (19.6 lb)
Video output	3G/HD-SDI 5 lines (embedded audio is supported only for HD signals)
	12G/6G/3G/HD-SDI 2 lines
	HD-SDI 1 line (shared with picture monitor output*2)
	Analog composite 2 lines (1 line shared with picture monitor output*2)
HD TRUNK/TICO output	When HD TRUNK: HD-SDI (Supported format: 1080/59i or 1080/50i), 3G/HD-SDI 1 line
Return input	3G-HD/HD/SD-SDI 4 lines (RET1 input has active-through output)
	Analog composite 1 line
Prompter input	HD-SDI 1 line (with active-through output)
	Analog composite 2 lines (through output of 1 and input of 2 share the connector*2) It is not terminated when the unit is turned OFF. No through output.
Reference input	BB (black burst) / tri-level*1 1 line (automatic termination, connect to upper connector; BB signal and tri-level signal automatically recognized, with loop-through output)
Microphone output	0 dBm/600 Ω 2 lines (XLR, 3-pin, male)
Communication	Intercom input/output (ENG / PROD, 0 dBm, 600 Ω (4 W) / 1 V [p-p], 200 Ω (RTS), 4 W / RTS / CLRCOM) 2 lines*2
	PGM input (0 dBm/600 Ω) 2 lines
	Tally input (red, green, yellow) 1 input each
AUX	WFM control 6-bit (open collector output, terminal shared with camera microphone gain setting*2)
	Camera microphone gain setting input 5-bit (photo-coupler input, terminal shared with WFM control*2)
	Down-conversion system setting input 2-bit (photo-coupler input)
TRUNK	RS-422 / RS-232C 2 lines*2
FRONT ROP	RS-422 1 line, 16 V DC output (only one of this and REAR ROP can be selected at one time via the menu or the [ROP FRONT/REAR] selection switch on the front panel)

REAR ROP	RS-422 1 line, 16 V DC output (only one of this and FRONT ROP can be selected at one time via the menu or the [ROP FRONT/REAR] selection switch on the front panel)
MSU	RS-422 1 line, GPI for control
LAN TRUNK	LAN connection with camera side via an optical cable*3 1 line, 100BASE-TX, 1000BASE-T
LAN	Personal computer connection for distribution via the Web*3 1 line, 10BASE-T, 100BASE-TX (use a crossover cable when connecting directly with a personal computer)

\*1: The BB (black burst) signal and tri-level sync signal of the reference input are recognized automatically.

\*2: Depending on the setting, only one of them can be selected at one time.

\*3: IP video is cannot be transmitted when [CCU MODE] is set to [2160/23.98p], [2160/23.98psf], [1080/23.98p], or [1080/23.98psF].

The symbols on this product (including the accessories) represent the following:

~ AC
Power on
○ Power off

#### NOTE

- For details on the maximum lengths of connection cables, consult your dealer.

Inrush current, measured according to European standard EN55103-1, on initial switch-on: 3 A, after a supply interruption of 5 s: 80 A

# Index

## A

Accessories .....	14
AC power socket .....	25
ANALOG GAIN .....	96
ANALOG PROMPT1 IN connector .....	23
ANALOG PROMPT2 IN/OUT connectors .....	23
AUDIO .....	85
Auto displays .....	39
AUX .....	95
AUX connector .....	25, 176

## B

BAR ID .....	74
--------------	----

## C

CABLE indicators .....	21
CALL button .....	21
CAMERA connector .....	25, 182
CAMERA No. display .....	20
CAMERA POWER button .....	20
CCU INTERCOM RECEIVE .....	86
CCU INTERCOM TALK .....	86
COMMUNICATION .....	87
COMMUNICATION connector .....	25, 179
Connection .....	18
Cooling fan .....	25

## E

Easy IP Setup Software .....	119
EasyIP Setup Tool Plus .....	147

## F

FORMAT(MOIP) .....	91
--------------------	----

## H

HD CHROMA .....	84
HD DETAIL .....	81, 82
HD PHASE .....	69
HD SDI OUT connectors .....	23
HD SDI PROMPT IN connector .....	23, 26
HD SDI PROMPT OUT connector .....	23
HD SKIN TONE DTL .....	83, 84
HD TRUNK/TICO OUT connector .....	23, 26

## I

INCOM LEVEL adjustment dial .....	21
INITIALIZE .....	116
INTERCOM1 .....	88
INTERCOM2 .....	89
INTERCOM connector .....	20, 176
IP connection .....	18
IRIS .....	30

## L

LAN2 connector .....	26
LAN connector .....	25
LAN TRUNK connector .....	24
Live screen .....	125

## M

MAINTENANCE .....	92
Memory card access lamp .....	22
Memory card slot .....	22
Menu	
Displaying .....	41
Operations .....	40
MENU button .....	22
MIC connector .....	25, 181
MIC OUT .....	85
MIC switch .....	21
MONITOR .....	76
MSU connector .....	25, 181

## N

ND/CC NAME .....	96, 97
NETWORK .....	98
NETWORK(MOIP) .....	99

## O

OPERATION .....	48
Operation displays .....	38
OPTICAL LEVEL indicators .....	20
OUT FORMAT(HD) .....	57, 58, 62
OUT FORMAT(HD_HDR) .....	64
OUT FORMAT(HS) .....	57
OUT FORMAT(HS_HDR) .....	62
OUT FORMAT(UHD) .....	55
OUT FORMAT(UHD_HDR) .....	60

**P**

PGM .....	90
PGM LEVEL adjustment dial .....	21
PGM switch .....	21
Picture monitor .....	27
Plug-in viewer software .....	121
PM OPERATION STATUS.....	114
PM VIEW SETTING .....	112, 113
POWER lamp .....	20
POWER switch .....	20
PRIV indicator.....	21
PRIV/SYSTEM selector switch.....	21
PROD/BOTH/ENG selector switch.....	21

**R**

REF connectors.....	24
RET1 IN to RET4 IN connectors .....	23
RET1 OUT connectors .....	23
ROP connector .....	22, 25, 180
ROP FRONT/REAR selector switch.....	22

**S**

SD CARD .....	117
SD PHASE .....	69
SELECT dial .....	22
SELECT RETURN.....	75
Serial connection .....	18
SETTING .....	67, 68
SETTING(MOIP) .....	77
SETUP.....	93
Setup screen .....	129
SFP+1 slot.....	26
SFP+2 slot.....	26
SIGNAL GND terminal.....	25
START UP .....	93
Status .....	32, 33, 34, 35, 36, 37
Status displays .....	31
Status display screen .....	31
STATUS indicators.....	21
STBY INTERCOM .....	87
SYSTEM.....	115
SYSTEM MODE .....	49

**T**

TALLY lamps.....	20
TRUNK connector .....	25, 178

**U**

UHD CHROMA.....	80
UHD DETAIL.....	78
UHD/HS/HD SDI OUT connectors .....	23, 26
UHD SETTING .....	78
UHD SKIN TONE DETAIL .....	79, 80
USER1 and USER2 buttons.....	22

**V**

VBS OUT connector .....	23
VBS PM OUT connector.....	23
VBS RET IN connector .....	23
VERSION .....	111

**W**

WARNING .....	29
Web Screen .....	119
Web Screen (AK-NP600) .....	147





**Panasonic Connect Co., Ltd.**

Web Site: <https://pro-av.panasonic.net/en/>

© Panasonic Connect Co., Ltd. 2018 - 2022