

Panasonic®

Operating Instructions

Memory Card Portable Recorder

Model No. **AJ-PG50**

P2HD

micro
P2

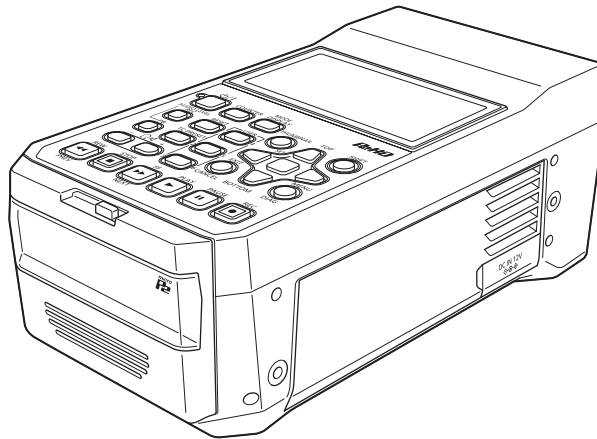

HDMI



AVCULTRA

AVCINTRA

AVC LongG

DVCPROHD

DVCPRO50

DVCPRO

DV

Before operating this product, please read the instructions carefully and save this manual for future use.

PJ E EJ ED AN PX

W1214MN7042 -PS

ENGLISH

VQT5L34A-7 (E)

Read this first!



CAUTION: TO REDUCE THE RISK OF ELECTRIC SHOCK, DO NOT REMOVE COVER (OR BACK). NO USER-SERVICEABLE PARTS INSIDE. REFER SERVICING TO QUALIFIED SERVICE PERSONNEL.



The lightning flash with arrowhead symbol, within an equilateral triangle, is intended to alert the user to the presence of uninsulated "dangerous voltage" within the product's enclosure that may be of sufficient magnitude to constitute a risk of electric shock to persons.



The exclamation point within an equilateral triangle is intended to alert the user to the presence of important operating and maintenance (servicing) instructions in the literature accompanying the appliance.

WARNING:

- To reduce the risk of fire or electric shock, do not expose this equipment to rain or moisture.
- To reduce the risk of fire or electric shock, keep this equipment away from all liquids. Use and store only in locations which are not exposed to the risk of dripping or splashing liquids, and do not place any liquid containers on top of the equipment.

WARNING:

Always keep memory cards (optional accessory) out of the reach of babies and small children.

CAUTION:

The mains plug of the power supply cord shall remain readily operable.
The AC receptacle (mains socket outlet) shall be installed near the equipment and shall be easily accessible.
To completely disconnect this equipment from the AC mains, disconnect the mains plug from the AC receptacle.

CAUTION:

Danger of explosion or fire if battery is incorrectly replaced or mistreated.

- Do not disassemble the battery or dispose of it in fire.
- Do not store in temperatures over 60 °C (140 °F).
- Do not expose the battery to excessive heat such as sunshine, fire or the like.

For Battery Pack

- Use specified charger.
- Replace only with same or specified type.

CAUTION:

In order to maintain adequate ventilation, do not install or place this unit in a bookcase, built-in cabinet or any other confined space. To prevent risk of electric shock or fire hazard due to overheating, ensure that curtains and any other materials do not obstruct the ventilation.

CAUTION:

To reduce the risk of fire or electric shock and annoying interference, use the recommended accessories only.

CAUTION (For USA and Canada):

This apparatus can be operated at a voltage in the range of 100 – 240 V AC.
Voltages other than 120 V are not intended for U.S.A. and Canada.
Operation at a voltage other than 120 V AC may require the use of a different AC plug. Please contact either a local or foreign Panasonic authorized service center for assistance in selecting an alternate AC plug.

CAUTION:

Excessive sound pressure from earphones and headphones can cause hearing loss.

CAUTION:

Do not leave the unit in direct contact with the skin for long periods of time when in use.
Low temperature burn injuries may be suffered if the high temperature parts of this unit are in direct contact with the skin for long periods of time.
When using the equipment for long periods of time, make use of the tripod.

CAUTION (For USA and Canada):

To prevent electric shock, match wide blade of plug to wide slot, fully insert.

 indicates safety information.

FCC NOTICE (U.S.A.)

Declaration of Conformity

Model Number: AJ-PG50
Trade Name: Panasonic
Responsible Party: Panasonic Corporation of North America Two Riverfront Plaza, Newark, NJ 07102
Support contact: 1-800-524-1448

This device complies with part 15 of the FCC Rules.

Operation is subject to the following two conditions:

(1) This device may not cause harmful interference, and (2) this device must accept any interference received, including interference that may cause undesired operation.

FCC Warning:

To assure continued FCC emission limit compliance, follow the attached installation instructions and the user must use only shielded interface cables when connecting to host computer or peripheral devices. Also, any unauthorized changes or modifications to this equipment could void the user's authority to operate this device.

FCC CAUTION:

This equipment has been tested and found to comply with the limits for a Class B digital device, pursuant to Part 15 of the FCC Rules. These limits are designed to provide reasonable protection against harmful interference in a residential installation. This equipment generates, uses and can radiate radio frequency energy and, if not installed and used in accordance with the instructions, may cause harmful interference to radio communications. However, there is no guarantee that interference will not occur in a particular installation. If this equipment does cause harmful interference to radio or television reception, which can be determined by turning the equipment off and on, the user is encouraged to try to correct the interference by one or more of the following measures:

- Reorient or relocate the receiving antenna.
- Increase the separation between the equipment and receiver.
- Connect the equipment into an outlet on a circuit different from that to which the receiver is connected.
- Consult the dealer or an experienced radio/TV technician for help.

The user may find the booklet "Something About Interference" available from FCC local regional offices helpful.

NOTIFICATION (Canada)

CAN ICES-003(B)/NMB-003(B)

 indicates safety information.



For USA and Canada

A lithium ion/polymer battery that is recyclable powers the product you have purchased. Please call 1-800-8-BATTERY for information on how to recycle this battery.

Notice (U.S.A. only):

Disposal may be regulated in your community due to Environmental considerations. For disposal or recycling information, please visit Panasonic website: <https://holdings.panasonic/global/corporate/sustainability.html> or call 1-888-769-0149.

Note:

The rating plate is on the underside of the Recorder, Battery Charger and AC Adaptor.

Turkey Only

AEEE Yönetmeliğine Uygundur.
AEEE Complies with Directive of Turkey.

IMPORTANT SAFETY INSTRUCTIONS

- 1) Read these instructions.
- 2) Keep these instructions.
- 3) Heed all warnings.
- 4) Follow all instructions.
- 5) Do not use this apparatus near water.
- 6) Clean only with dry cloth.
- 7) Do not block any ventilation openings. Install in accordance with the manufacturer's instructions.
- 8) Do not install near any heat sources such as radiators, heat registers, stoves, or other apparatus (including amplifiers) that produce heat.
- 9) Do not defeat the safety purpose of the polarized or grounding-type plug. A polarized plug has two blades with one wider than the other. A grounding-type plug has two blades and a third grounding prong. The wide blade or the third prong are provided for your safety. If the provided plug does not fit into your outlet, consult an electrician for replacement of the obsolete outlet.
- 10) Protect the power cord from being walked on or pinched particularly at plugs, convenience receptacles, and the point where they exit from the apparatus.
- 11) Only use attachments/accessories specified by the manufacturer.
- 12) Use only with the cart, stand, tripod, bracket, or table specified by the manufacturer, or sold with the apparatus. When a cart is used, use caution when moving the cart/apparatus combination to avoid injury from tip-over.
- 13) Unplug this apparatus during lightning storms or when unused for long periods of time.
- 14) Refer all servicing to qualified service personnel. Servicing is required when the apparatus has been damaged in any way, such as power-supply cord or plug is damaged, liquid has been spilled or objects have fallen into the apparatus, the apparatus has been exposed to rain or moisture, does not operate normally, or has been dropped.



ІНФОРМАЦІЯ ПРО ПІДТВЕРДЖЕННЯ ВІДПОВІДНОСТІ ПРОДУКТУ

| | | |
|--------------------|-----------------------------|-----------------------------|
| Виробник: | Panasonic Connect Co., Ltd. | Панасонік Коннект Ко., Лтд. |
| Адреса виробника: | Fukuoka Japan | Фукуока Японія |
| Країна походження: | China | Китай |

| | |
|-------------------|--|
| Імпортер: | ТОВ "ПАНАСОНІК УКРАЇНА ЛТД" |
| Адреса імпортера: | вул. Васильківська, буд. 30, м. Київ, 03022, Україна |

Примітки:

| | |
|----------------------|---------|
| Термін служби виробу | 7 років |
|----------------------|---------|

Дату виготовлення можна визначити за комбінацією букв і цифр серійного номера, що розташований на маркувальній таблиці виробу.

Приклад:

X X XXXXXXX

Рік: остання цифра року (4 – 2014, 5 – 2015,...0 – 2020)

Місяць: А – Січень, В – Лютий... L – Грудень

Caution for AC Mains Lead

FOR YOUR SAFETY PLEASE READ THE FOLLOWING TEXT CAREFULLY.

This product is equipped with 2 types of AC mains cable. One is for continental Europe, etc. and the other one is for U.K.

Appropriate mains cable must be used in each local area, since the other type of mains cable is not suitable.

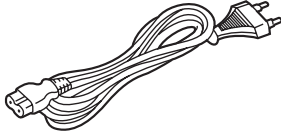

FOR CONTINENTAL EUROPE, ETC.
Not to be used in the U.K.

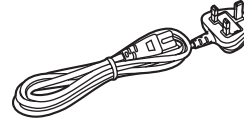

FOR U.K.



FOR U.K. ONLY

This appliance is supplied with a moulded three pin mains plug for your safety and convenience. A 5 amp fuse is fitted in this plug. Should the fuse need to be replaced please ensure that the replacement fuse has a rating of 5 amps and that it is approved by ASTA or BSI to BS1362. Check for the ASTA mark  or the BSI mark  on the body of the fuse.

If the plug contains a removable fuse cover you must ensure that it is refitted when the fuse is replaced. If you lose the fuse cover the plug must not be used until a replacement cover is obtained. A replacement fuse cover can be purchased from your local Panasonic Dealer.

How to replace the fuse

- 1. Open the fuse compartment with a screwdriver.

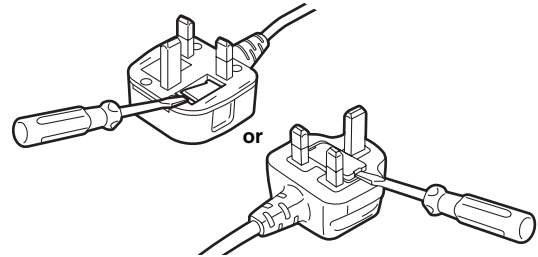

- 2. Replace the fuse

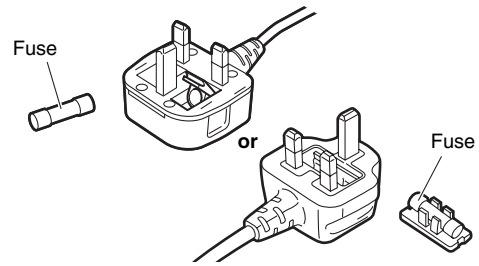

 indicates safety information.

EMC NOTICE FOR THE PURCHASER/USER OF THE APPARATUS

1. Pre-requisite conditions to achieving compliance with the above standards

<1> Peripheral equipment to be connected to the apparatus and special connecting cables

- The purchaser/user is urged to use only equipment which has been recommended by us as peripheral equipment to be connected to the apparatus.
- The purchaser/user is urged to use only the connecting cables described below.

<2> For the connecting cables, use shielded cables which suit the intended purpose of the apparatus.

- Video signal connecting cables
Use double shielded coaxial cables, which are designed for 75-ohm type high-frequency applications, for SDI (Serial Digital Interface).
Coaxial cables, which are designed for 75-ohm type high-frequency applications, are recommended for analog video signals.
- Audio signal connecting cables
If your apparatus supports AES/EBU serial digital audio signals, use cables designed for AES/EBU. Use shielded cables, which provide quality performance for high-frequency transmission applications, for analog audio signals.
- Other connecting cables
Use shielded cables, which provide quality performance for high-frequency applications, such as connecting cables for IEEE1394 or USB.
- When connecting to the HDMI signal terminal, use multilayer shielded cables, which provide quality performance for high-frequency applications.
- When connecting to the DVI signal terminal, use a cable with a ferrite core.
- If your apparatus is supplied with ferrite core(s), they must be attached on cable(s) following instructions in this manual.

2. Performance level

The performance level of the apparatus is equivalent to or better than the performance level required by these standards.

However, the apparatus may be adversely affected by interference if it is being used in an EMC environment, such as an area where strong electromagnetic fields are generated (by the presence of signal transmission towers, cellular phones, etc.). In order to minimize the adverse effects of the interference on the apparatus in cases like this, it is recommended that the following steps be taken with the apparatus being affected and with its operating environment:

1. Place the apparatus at a distance from the source of the interference.
2. Change the direction of the apparatus.
3. Change the connection method used for the apparatus.
4. Connect the apparatus to another power outlet where the power is not shared by any other appliances.

Importer for UK:
Panasonic Connect UK,
a branch of Panasonic Connect Europe GmbH,
Maxis 2, Western Road, Bracknell, Berkshire, RG12 1RT



Manufactured by: Panasonic Connect Co., Ltd.
4-1-62 Minoshima, Hakata-ku, Fukuoka 812-8531, Japan
Importer: Panasonic Connect Europe GmbH
Authorized Representative in EU: Panasonic Testing Centre
Winsbergring 15, 22525 Hamburg, Germany

Read this first! (continued)

■ Batteries that may be used with this product (as of April 2019)

Panasonic AG-VBR59 / AG-VBR89 / AG-VBR118 / VW-VBD55 / VW-VBD58 batteries may be used with this product.

It has been found that counterfeit battery packs which look very similar to the genuine product are made available to purchase in some markets. Some of these battery packs are not adequately protected with internal protection to meet the requirements of appropriate safety standards. There is a possibility that these battery packs may lead to fire or explosion. Please be advised that we are not liable for any accident or failure occurring as a result of use of a counterfeit battery pack. To ensure that safe products are used we would recommend that a genuine Panasonic battery pack is used.

Battery Charger / AC Adaptor

Disconnect the AC mains plug from the AC mains socket when not in use.

Note regarding the Power Management function specified under COMMISSION REGULATION (EC) No 1275/2008 implementing Directive 2009/125/EC of the European Parliament and of the Council.

This device is designed and manufactured for use at a broadcasting station and/or in a similar environment.

This device is not equipped with a Power Management function or the Power Management function is set to OFF as it will prevent the device from fulfilling its intended purpose for the reasons below.

1. If the device is a Studio Camera, a Weather Camera, a Mixer or other processor:
A Power Management function may cause the device to suddenly stop during recording or while On Air.
2. If the device is a Studio Monitor:
A Power Management function may cause video for the confirmation of whether a signal is normal, or whether the signal has been lost, to be un-viewable.
3. If the device is a Camera Recorder:
A professional camera recorder must be able to start quickly at any time, but a Power Management function will cause an increase in the time taken to resume from Stand-by mode.



To remove the battery

Main Power Battery

Press the battery release button.

Back-up Battery

- For the removal of the battery for disposal at the end of its service life, please consult your dealer.

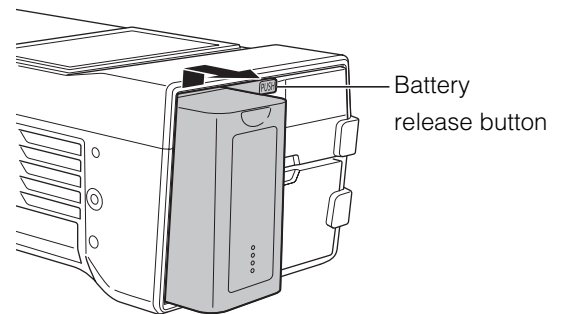

Brazil Only Brasil Apenas

■ Manuseio de baterias usadas

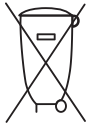

BRASIL

Após o uso, as pilhas e/ou baterias deverão ser entregues ao estabelecimento comercial ou rede de assistência técnica autorizada.

Cobrir os terminais positivo (+) e negativo (-) com uma fita isolante adesiva, antes de depositar numa caixa destinada para o recolhimento. O contato entre partes metálicas pode causar vazamentos, gerar calor, romper a blindagem e produzir fogo. Não desmonte, não remova o invólucro, nem amasse a bateria. O gás liberado pela bateria pode irritar a garganta, danificar o lacre do invólucro ou o vazamento provocar calor, ruptura da blindagem e produzir fogo devido ao curto circuito dos terminais. Não incinere nem aqueça as baterias, elas não podem ficar expostas a temperaturas superiores a 100 °C (212 °F). O gás liberado pela bateria pode irritar a garganta, danificar o lacre do invólucro ou o vazamento provocar calor, ruptura da blindagem e produzir fogo devido ao curto circuito dos terminais provocado internamente.

Evite o contato com o líquido que vazar das baterias. Caso isto ocorra, lave bem a parte afetada com bastante água. Caso haja irritação, consulte um médico.

■ Para remover a bateria

Bateria Principal de Energia

Pressione o botão para liberar a bateria.

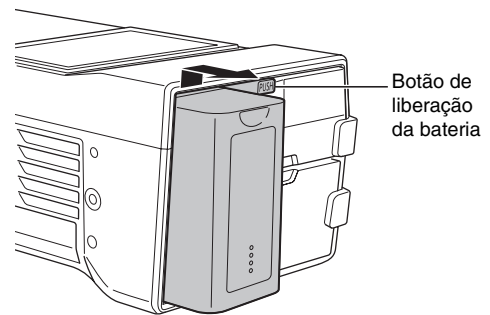

WARNING: **THIS PRODUCT CONTAINS A COIN BATTERY**

Keep coin battery out of the reach of infants and small children whether the battery is new or used. Severe or fatal injuries can occur within 2 hours of ingestion. Seek medical attention immediately.

This symbol is only valid in TAIWAN.



廢電池請回收

< Предупреждение >

Следуйте нижеприведённым правилам, если иное не указано в других документах.

1. Устанавливайте прибор на твёрдой плоской поверхности, за исключением отсоединяемых или несъёмных частей.
2. Хранить в сухом, закрытом помещении.
3. Во время транспортировки не бросать, не подвергать излишней вибрации или ударам о другие предметы.
4. Утилизировать в соответствии с национальным и/или местным законодательством.

Правила и условия реализации не установлены изготовителем и должны соответствовать национальному и/или местному законодательству страны реализации товара.

■ The symbols on this product (including the accessories) represent the following. (Some symbols are not displayed on this unit.)

- I ON
- ⏻ Standby (OFF)
- ~ AC
- == DC
- Class II equipment (The construction of the product is double-insulated.)

- The SDXC logo is a trademark of SD-3C, LLC.
- The terms HDMI and HDMI High-Definition Multimedia Interface, and the HDMI Logo are trademarks or registered trademarks of HDMI Licensing Administrator, Inc. in the United States and other countries.
- Microsoft® and Windows® are registered trademarks or trademarks of Microsoft Corporation in the United States and/or other countries.
- QuickTime and the QuickTime logo are trademarks or registered trademarks of Apple Inc., used under license therefrom.
- Apple, Mac, Mac OS, MacBook, iPhone, iPod touch, iPad, QuickTime, and Safari are registered trademarks of Apple Inc. in the United States and/or other countries.
- Microsoft product screenshots are used in accordance with the guidelines of Microsoft Corporation.
- Other company names and product names appearing in this manual are trademarks or registered trademarks of their respective owners.

Illustrations in this manual

- Illustrations of the recorder unit and menu screens may appear different from the actual recorder unit and menu screens.

Page references

- In this manual, page references are indicated as: (→ “***” page **).

Terminology

- An SD memory card, SDHC memory card, and SDXC memory card are all referred to as an “SD memory card.”
- A memory card with the “P2” logo (for example, the separately sold AJ-P2E064FG) is referred to as a “P2 memory card.”
- A memory card with the “microP2” logo (for example, the separately sold AJ-P2M032AG) is referred to as a “microP2 memory card.”
- A P2 memory card and microP2 memory card are referred to as a “P2 card.”
Furthermore, a P2 memory card slot and microP2 memory card slot are referred to as a “P2 card slot.”
- Recording with the system frequency at 23.98 Hz or 24 Hz is referred to as “native recording.”
- In this manual, the following operating system is referred to as “Windows 7.”
- Microsoft® Windows® 7 operating system
- In this manual, the following operating system is referred to as “Windows 8.”
- Microsoft® Windows® 8 operating system
- A recordable media device such as an external hard disk drive connected to a USB port is referred to as a “storage device.”
- Video created by a single recording operation is referred to as a “clip.”
- Orange button labels on the unit panel indicate alternate functions enabled by holding down the [SHIFT] button. The operating instructions refer to the buttons only by label, without mentioning the [SHIFT] button.

Proxy recording with this product

This product is licensed under the AVC Patent Portfolio license for personal and non-commercial use, and is not licensed for any activity except those for personal use described below.

- Recording video compliant with the AVC standard (hereinafter referred to as an AVC video).
- Playing AVC video recorded by a consumer engaged in a personal and non-commercial activity.
- Playing AVC video that was obtained from a licensed provider.

For details, refer to the MPEG LA, LLC website (<http://www.mpegla.com>).

Website URL

<https://pro-av.panasonic.net/>

About copyrights

- Copyright laws may prohibit use, except for personal pleasure, of your recorded video and audio content without permission of the rights holder.

Contents

| | | | |
|---|----|--|-----|
| Read this first!..... | 2 | Adding Metadata to Clips During Recording | 52 |
| Usage Precautions | 11 | Formatting P2 Cards and SD Memory Cards | 54 |
| Regarding this unit | 11 | Checking the Card Status | 54 |
| AC adaptor | 12 | Manual and Automatic CPS Authentication | 55 |
| Battery | 12 | Connecting an External Device via the USB HOST Port | 57 |
| Battery characteristics | 12 | Using the Unit Connected to a Network | 65 |
| Remove the battery after use | 12 | Network Connection | 65 |
| Take proper care of the battery terminal | 13 | Preparing for Connection | 66 |
| Before Use | 13 | Network Settings | 67 |
| Setting the Area of Use (Frame Frequency and Other Settings) | 13 | Network Functions | 72 |
| Always confirm the year, month, day, time, and time zone, and set as necessary | 13 | Using FTP Client Functions | 74 |
| Compatible storage media | 13 | Viewing the Thumbnails of Clips on an FTP Server (FTP Thumbnail Screen) | 75 |
| Driver installation | 13 | Deleting Clips on the FTP Server | 76 |
| Accessories | 13 | Viewing FTP Server Clip Information | 76 |
| Optional Accessories | 13 | Transferring Clips | 76 |
| Control Reference Guide | 14 | Transferring SD Memory Card Data | 78 |
| Controls | 14 | Rec during upload function | 79 |
| Slots and I/O Controls | 16 | USB Device Mode | 82 |
| I/O Connectors and Power Components | 18 | P2 Playlist Editing Mode | 83 |
| Preparation | 20 | Screen Display..... | 84 |
| Power Supply | 20 | OSD Display | 84 |
| Charging the Battery | 20 | Deck Information (DIAG) Display | 86 |
| Using the Battery | 22 | Waveform Monitor (WFM) Display | 86 |
| Installation | 22 | Time Code, User Bits, and CTL..... | 87 |
| Removal | 22 | Time code | 87 |
| Using the AC Adaptor | 23 | User Bits | 87 |
| Installation | 23 | CTL | 87 |
| Removal | 23 | Setting the Time Code and User Bits | 87 |
| How to Turn On/Off the Power | 24 | Setup Menu | 89 |
| Turning On the Power | 24 | Menu Operations | 89 |
| Turning Off the Power | 24 | Menu Structure | 90 |
| Auto Power Off during Operation | 24 | Menu List | 92 |
| Setting the Year, Month, Day, and Time | 25 | CLIP | 92 |
| P2 Cards | 26 | REC/PB | 97 |
| P2 Card Access Lamp and P2 Card Status | 26 | I/F SETUP | 102 |
| P2 Card Recording Times | 26 | FILE | 111 |
| Handling of Recording Data | 28 | SYSTEM | 114 |
| Using SD/SDHC/SDXC Memory Cards | 29 | List of Compatible Input and Output Formats | 116 |
| Available Modes | 30 | Using a Keyboard | 117 |
| Main Mode | 31 | Full Keyboard | 117 |
| Recording/Playback Screen | 31 | Numeric Keyboard | 117 |
| Recording Clips | 31 | USB Keyboard | 117 |
| Streaming function | 34 | For Long and Trouble-Free Operation..... | 118 |
| Playing Back Clips | 37 | Maintenance | 118 |
| Thumbnail Screen | 40 | Condensation | 118 |
| Displaying the Thumbnail Screen | 40 | Storage Precautions | 118 |
| Names and Functions of the Parts of the Thumbnail Screen | 41 | Warning System | 119 |
| Changing the Thumbnail Display | 44 | Warning Details | 119 |
| Playing Back Clips | 45 | Error Codes | 120 |
| Selecting and Deselecting Clips | 47 | Updating the Firmware in This Unit | 127 |
| Adding Text Memos and Shot Marks | 47 | Specifications..... | 128 |
| Copying Clips | 48 | Index..... | 132 |
| Deleting Clips | 49 | | |
| Repairing and Reconnecting Clips | 49 | | |
| Viewing and Editing the Clip Information | 50 | | |
| Changing Thumbnails | 51 | | |

Usage Precautions

Regarding this unit

■ Panasonic Connect Co., Ltd. makes no guarantees regarding recordings

- Please note that Panasonic Connect Co., Ltd. makes no guarantees regarding recordings in cases where images and/or audio were not recorded as you intended due to problems with this unit or P2 cards.

■ Be careful to avoid getting water inside the unit when using it in rainy or snowy weather, or near the sea shore.

- The unit or a card may be damaged. (In some cases, it may become unrepairable.)

■ Do not install this unit in a location exposed to direct sunlight.

- The cabinet may be deformed and the LCD screen may be damaged.

■ Keep the unit away from electromagnetic devices (such as TVs and video game consoles).

- Using the unit on or near a TV may result in distorted images or audio due to electromagnetic radiation.
- The strong magnetic field produced by loudspeakers and large monitors may damage recordings or distort images.
- Electromagnetic waves from microcomputers may adversely affect the unit or distort images and audio.
- If an electromagnetic device adversely affects the unit and results in it becoming unable to be operated correctly, turn the unit off and disconnect the AC cable from the outlet. Then, reconnect the AC cable. Finally, turn the unit back on.

■ Do not use the unit near a radio transmitter or high-voltage equipment.

- Use near a radio transmitter or high-voltage equipment may adversely affect recorded images and audio.

■ When using the unit at the sea shore, in the open air, etc., be careful not to get sand or dust inside.

- The sand or dust may damage the unit or a card. (Be especially careful when inserting and removing cards.)

■ When carrying the unit, be careful not to drop it.

- A strong impact may damage the unit and result in it becoming unable to be operated correctly.

■ Do not get insecticides or other volatile materials on the unit.

- The unit may be deformed and the paint may peel off if insecticides or other volatile materials get on the unit.
- Do not leave the unit in contact with rubber or vinyl products for long periods.

■ Notes on the disposal or transfer of memory cards and storage devices

The format and delete functions on this unit or a computer will only change the file management data and will leave the data on the memory card or storage device intact. It is recommended that cards or storage devices either be physically destroyed or that commercially available software be used to completely delete any data they contain. Management of data on memory cards and storage devices is the sole responsibility of the user.

■ LCD

- The pixels of the LCD monitor are controlled to obtain high precision with 99.99% of the effective pixels. This leaves less than 0.01% of pixels that may not light or may remain on all the time. This is normal and will have no effect on the images you shoot.
- There may be some unevenness on the screen depending on the image displayed.
- Wiping or rubbing the LCD screen with a rough cloth may damage it.
- LCD response and brightness vary with operating temperature.
- In a high-temperature and high-humidity location, the LCD panel characteristics may change and result in uneven image quality.
- If an unsupported signal is input to the unit for a long period of time, the LCD panel characteristics may change and result in uneven image quality.
- Due to the characteristics of LCD monitors, prolonged display of bright still images or prolonged operation in high-temperature or high-humidity environments may result in residual images, luminance reduction, burn-in, banding, or panel defects and degradation that result in areas of permanently changed brightness.

In particular, avoid prolonged continuous display of the following types of images.

- Bright still images
- Images that include logomarks or graphics in fixed positions
- Thumbnail screens
- Windows from a computer and similar bright displays
- Images with aspect ratios different from that of the monitor (e.g., letterboxed images)

In addition, avoid prolonged continuous use in the following types of environments.

- Confined areas with high temperature and humidity
 - Near the exhaust vent of air conditioning equipment, etc.
- Prolonged use involving the images and environments described above will accelerate deterioration of the LCD panel over time.

To prevent accelerated deterioration and its related phenomena, we recommend the following.

- Do not display bright still images for prolonged periods.
- Lower the brightness.
- Turn off the power when the monitor is not in use.

Residual images will gradually disappear as different images are displayed.

■ Notes on using the network function

Please note that Panasonic Connect Co., Ltd. makes no guarantees regarding damage resulting from incorrectly configuring the network settings to use the network function. Furthermore, please also note that Panasonic Connect Co., Ltd. is not liable to pay compensation for any damages arising from the use of this function.

■ Notes on security

If you use the network function of this product, there is the likelihood of being subjected to the following damage.

- Leakage of personal information via this product
- Unauthorized operation of this product by a third party with malicious intent
- Interference or stoppage of this product by a third party with malicious intent

Be sure to implement sufficient security measures for computers and mobile devices.

- Set a password to limit the users who can log in.
- Use a password that is as difficult to guess as possible.
- Change the password regularly.
- Panasonic Connect Co., Ltd. and its affiliate companies would never directly inquire about a password. In the event that somebody does make a direct inquiry, do not let the person know the password.
- Prior to the repair, maintenance, disposal, or transfer of this product, initialize the network settings to prevent the leakage of information.

■ Information on software for this product

1. This product includes software licensed under the GNU General Public License (GPL) and GNU Lesser General Public License (LGPL), and users are hereby informed that they have the right to obtain, modify, and redistribute the source code of this software.
2. This product includes software licensed under the MIT-License.
3. This product includes software developed by the OpenSSL Project for use in the OpenSSL Toolkit (<http://www.openssl.org/>).
4. This product includes software licensed under the OpenBSD License.
5. This product includes PHP, freely available from <http://www.php.net/>.
6. This software is based in part on the work of the Independent JPEG Group.
7. This product includes software licensed under the MOZILLA PUBLIC LICENSE.

To see the details (in the original (English-language) text) and obtain the source code, visit the following website. (→ “Website URL” on page 9)

Users are requested to refrain from making any inquiries about the source code they have obtained.

AC adaptor

Use the supplied AC adaptor. Read the Operating Instructions (→ “Using the AC Adaptor” page 23) before use.

Battery

Battery characteristics

This unit uses a rechargeable lithium-ion battery that uses its internal chemical reaction to generate electrical energy. This reaction is easily influenced by the ambient temperature and humidity, and the battery’s effective operating time is reduced as the temperature rises or falls. In very low temperatures, the battery may last only 5 minutes.

Protective circuitry functions if you use the battery where it is very hot and you will have to wait before you can use it again.

Remove the battery after use

Completely remove the battery. (The battery continues to be used even if you have turned the unit off.) The battery can over discharge if you leave it in the unit and it may become impossible to recharge it.

Take proper care of the battery terminal

Do not allow dust or foreign objects on the battery terminal.

Also, if you drop the battery by mistake, make sure that the battery body and the terminal are not warped.

Inserting a deformed battery into the unit or attaching it to the battery charger may cause damages on the unit or battery charger.

Before Use

Setting the Area of Use (Frame Frequency and Other Settings)

This unit is shipped with the area of use unset. Before using the unit for the first time, refer to the included leaflet.

Always confirm the year, month, day, time, and time zone, and set as necessary

The clock setting affects the management of recorded content and playback order. Before recording, set and confirm the year, month, day, time, and time zone settings.

If the unit is left without an electric power supply for a long period of time (approximately 3 months), "BACKUP BATT EMPTY" may be displayed when the power is turned on. If that happens, set the date and time information because it has been initialized. (→ "Setting the Year, Month, Day, and Time" page 25)

Also charge the backup battery. (→ "BACKUP BATT EMPTY" page 121)

Compatible storage media

The following types of storage media can be used. See the specified pages for details.

■ Recording and playback

- P2 memory cards and microP2 memory cards (→ "P2 Cards" page 26)

■ Proxy recording and data storage

- SD, SDHC, and SDXC memory cards (→ "Using SD/SDHC/SDXC Memory Cards" page 29)

Driver installation

Before use, download the necessary drivers from the Panasonic website and install them on the personal computer.

For the installation procedure, refer to installation manual on the Panasonic website.

For the latest information on drivers, refer to the Panasonic website. Refer to (→ "Website URL" page 9)

Accessories

For details on the supplied accessories, refer to the included leaflet.

Optional Accessories

- AG-VBR59 (7.28 V/5900 mAh, product equivalent to the supplied battery)
- AG-VBR89 (7.28 V/8850 mAh)
- AG-VBR118 (7.28 V/11800 mAh)
- VW-VBD58 (7.2 V/5800 mAh)
- AG-BRD50 (8.4 V/4.0 A)
- AG-B23 (8.4 V/1.2 A)

Control Reference Guide

Controls

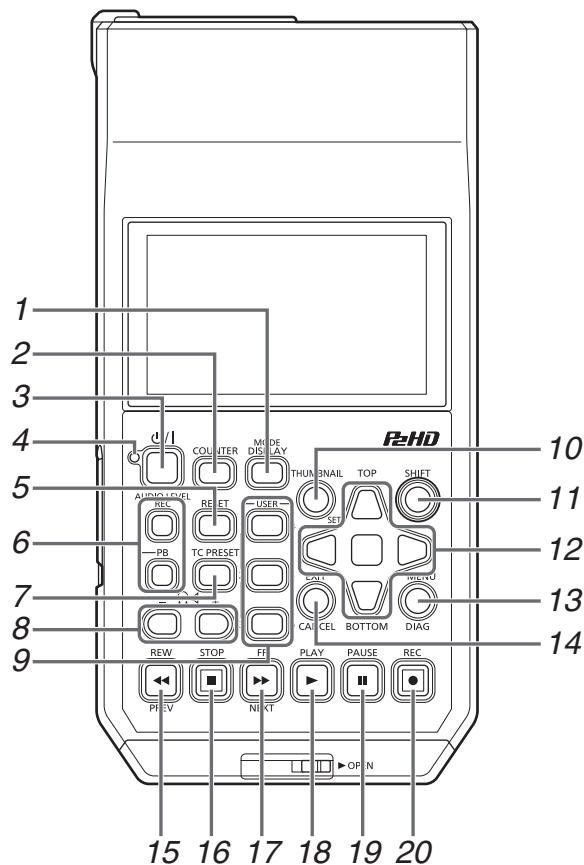

About button labels: Orange labels indicate alternate functions enabled by simultaneously pressing the [SHIFT] button. <Example> Press the [SHIFT] and [DISPLAY/MODE] buttons simultaneously to execute the [MODE] button function.

1. DISPLAY, **MODE** button

[DISPLAY] button:

This button toggles display of the OSD on and off.
(→ “Screen Display” page 84)

[MODE] button:

This button switches between USB device mode (USB DEVICE) and PLAYLIST editing mode.
(→ “USB Device Mode” page 82, “P2 Playlist Editing Mode” page 83)

2. COUNTER button

This button switches the counter display in the following order.

TC→UB→CTL→TC

(→ “Time Code, User Bits, and CTL” page 87)

3. **POWER** button

This button turns the power on or off.

(→ “How to Turn On/Off the Power” page 24)

4. **POWER** lamp

This button displays the operating status of the unit.

(→ “How to Turn On/Off the Power” page 24)

When an error is detected after the power is turned on or during operation, the **POWER** lamp and a beep sound notify you that an error has occurred. (→ “Warning Details” page 119)

5. RESET button

When the counter display on the display panel is CTL, press this button to reset the counter display to “0:00:00:00”.

(→ “Time Code, User Bits, and CTL” page 87)

6. AUDIO LEVEL buttons

[AUDIO LEVEL-REC] button:

This button displays the recording audio level adjustment screen.

(→ “Recording Clips” page 31)

[AUDIO LEVEL-PB] button:

This button displays the playback audio level adjustment screen.

(→ “Playing Back Clips” page 37)

7. TC PRESET button

This button sets the TC or UB value.
(→ “Time Code, User Bits, and CTL” page 87)

8. (Monitor volume adjustment) buttons

Monitor audio volume adjustment:

Press either the + or -,  button to display the loud-speaker/headphone audio volume level, and hold the button to adjust. Wait a short time or press [SET] or [EXIT] to return the display to normal.

9. USER 1-3, 4-6 buttons

Users can assign any functions to these buttons.
(→ “USER BUTTON” page 110)

10. THUMBNAIL button

This button displays or hides the thumbnail screen.
(→ “Displaying the Thumbnail Screen” page 40)

11. SHIFT button

Hold this button while pressing another button to perform the assigned function of that button.

12. Cursor control buttons

Up/down/left/right cursor buttons:

- These buttons control the cursor movement for thumbnails, menus, etc.
- During playback, press the Left/Right cursor buttons to activate SHTL mode to change playback speed.
(→ “Variable speed playback” page 37)
- Press the [SET] button to pause variable speed playback.
- Press the up or down cursor button during the display of playback still images to step one frame forward or back.
(→ “Frame-by-frame playback” page 38)
- Use the left or right cursor button to switch the audio channel for recording and playback audio level adjustment.
(→ “Recording Clips” page 31)

[TOP]/[BOTTOM] buttons:

These buttons move the cursor to the first (TOP) or last (BOTTOM) thumbnail.

[SET] button:

This button allows you to perform operations such as selecting thumbnails and menu items.

13. MENU, DIAG button

[MENU] button:

This button displays the menu.

[DIAG] button:

When the menu is not displayed, press this button to display the DIAG screen for viewing various conditions.
(→ “Deck Information (DIAG) Display” page 86)

14. EXIT, CANCEL button

[EXIT] button:

This button closes the menu or returns from the storage explorer to normal display.

[CANCEL] button:

This button cancels a selection, stops copying, etc.

15. REW, PREV button

[REW] button:

This button fast rewinds playback.

The speed can be selected in the “FF.REW MAX” (→ page 98) menu item.

[PREV] button:

This button cues the current or previous clip or the clip and text memo location during playback.

16. STOP button

This button stops playback or recording.

17. FF, NEXT button

[FF] button:

This button fast forwards playback.

The speed can be selected in the “FF.REW MAX” (→ page 98) menu item.

[NEXT] button:

This button cues the next clip or the clip and text memo location during playback.

18. PLAY button

This button starts playback.

(→ “Playing Back Clips” page 37)

19. PAUSE button

Press this button during playback to pause (STILL) playback to display a still image.

Press the button while playback is paused to resume playback.

Press the button during recording to switch to the recording standby (PAUSE) state.

Press the button in the recording standby state to resume recording.

20. REC button

This button allows you to check EE video and audio during playback image output. EE will continue while the button is being pressed.

EE mode monitoring is only available when the playback video format matches the setting in the “LINE&FREQ” (→ page 114) menu item. It will not function if recordable media does not exist.

Press this button and the [PLAY]  button simultaneously to start recording.

Press this button and the [PAUSE]  button simultaneously to switch to the recording standby state. Remote recording from a camera can be enabled from the menu. Set remote recording in the “AUTO REC” (→ page 97) menu item.

Slots and I/O Controls

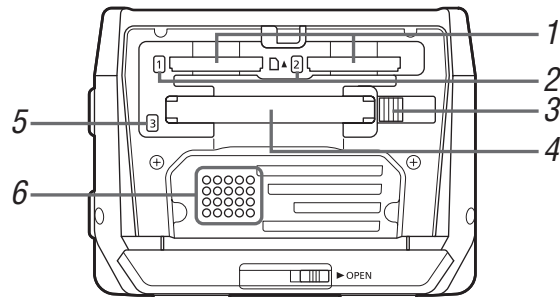

1. microP2 memory card slots

(→ “P2 Cards” page 26)

2. microP2 memory card access lamps

(→ “P2 Card Access Lamp and P2 Card Status” page 26)

3. EJECT button

(→ “P2 Cards” page 26)

4. P2 memory card slot

(→ “P2 Cards” page 26)

5. P2 memory card access lamp

(→ “P2 Card Access Lamp and P2 Card Status” page 26)

6. Speaker

This speaker outputs the monitor audio.

Output from the speaker is disabled when headphones are connected.

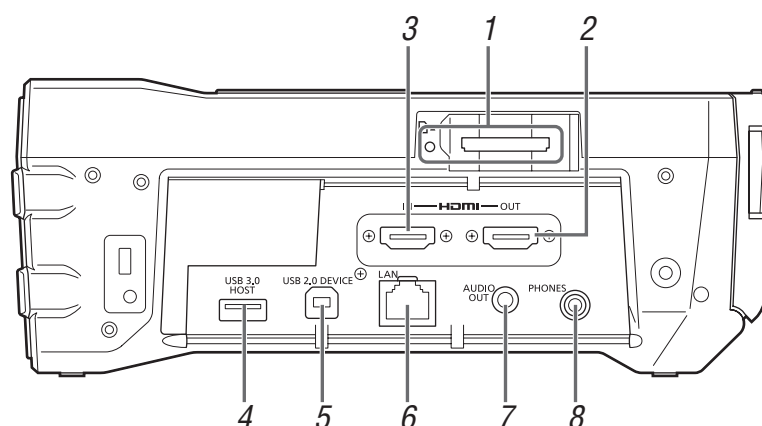

1. SD/SDHC/SDXC memory card slot and access lamp

Insert an SD/SDHC/SDXC memory card.
Insert the cut-corner-edge first with the label-side up, until the card latches into place.
When removing a card, check that the access lamp is not lit green, then release the latch by gently pushing the card in again.

◆Note:

Use SD/SDHC/SDXC memory cards for reading the CPS password, reading and writing menu settings, reading and writing metadata, and proxy recording.
(→ “Using SD/SDHC/SDXC Memory Cards” page 29)

2. HDMI OUT connector

Connect a monitor or TV using an HDMI cable.

◆Note:

- This unit does not support Viera Link. Be aware that connecting a Viera Link compatible device using an HDMI cable may cause Viera Link to malfunction on the other device.
- Use a double-shielded cable to connect to this port.
- When “VIDEO” - “INPUT SEL” is set to “HDMI”, EE video, audio, and other signals from the HDMI output connector will not be output. In addition, the thumbnail screen will not be output.

3. HDMI IN connector

Use an HDMI cable to connect a camera recorder, etc. here.

◆Note:

- This unit does not support Viera Link. Be aware that connecting a Viera Link compatible device using an HDMI cable may cause Viera Link to malfunction on the other device.
- Use a double-shielded cable to connect to this port.
- When HDCP signals are detected, external output is stopped and recording will not be possible. In addition, the thumbnail screen will not be output.
- This unit does not support 60 Hz JUST frequency signals. For the input signals, use 59.94 Hz or 50 Hz signals. Even when using 59.94 Hz or 50 Hz signals, if there is a discrepancy in the frequency, reception will not be possible (in the case of some computers, for example).
- When an input signal cannot be received, the “INVALID INPUT FORMAT” warning will be displayed and the video will be black and muted.

4. USB 3.0 HOST port (USB 3.0 Type A)

(→ “Connecting an External Device via the USB HOST Port” page 57)

◆Note:

- Use a double-shielded cable to connect to this port.
- Use a USB 3.0 compliant cable to connect USB 3.0 compatible storage devices.
- When using this unit with the battery, externally supply power to any storage device connected to the [USB3.0 HOST] port.

5. USB 2.0 device port

(→ “USB Device Mode” page 82)

◆Note:

Use a double-shielded cable to connect to this port.

6. LAN port

This port enables a 100BASE-TX/10BASE-T network connection.
(→ “Using the Unit Connected to a Network” page 65)

◆Note:

- Use a shielded cable to connect to this port.
- The orange lamp lights when a LAN link is established. The green lamp flashes while data is being transferred.

7. AUDIO OUT connector

Outputs the audio signals (CH1 to CH4) selected in the “MONITOR CH” (→ page 104) menu item.

8. PHONES (Headphone) jack

Headphone jack:

This jack is for connecting stereo headphones to listen to the sound being recorded or played back with the headphones.

I/O Connectors and Power Components

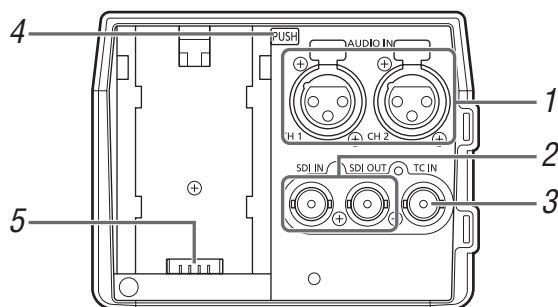

1. ANALOG AUDIO IN jacks

These jacks are for inputting analog audio.

2. HD/SD-SDI IN/OUT jacks

These jacks are for inputting and outputting serial digital component audio/video signals.

The output jack for superimposition can be changed in the "OSD OUTPUT" (→ page 108) menu setting, and the output jack for thumbnail screen superimposition can be changed in the "GUI OUTPUT" menu setting (→ page 108).

◆Note:

Use 5C-FB or equivalent double-shielded cables to connect to these jacks.

3. TIME CODE IN Jacks

This jack is for recording an external time code onto a P2 card.

4. Battery lock release button

(→ "Using the Battery" page 22)

5. Battery attachment point

(→ "Using the Battery" page 22)

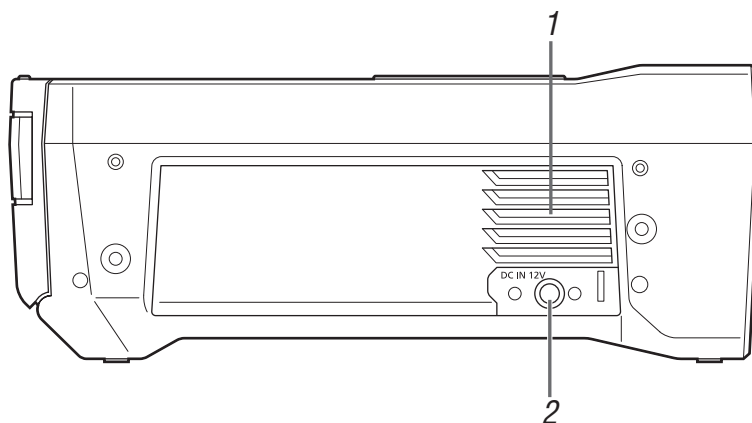

1. Fan

This fan is for cooling the unit. Install the unit where the ventilation holes will not be blocked.

◆ Note:

If the fan is stopped while the power is on, the “FAN STOPPED” (→ page 121) warning is displayed. Stop operation and turn off the unit immediately, and contact your dealer.

2. DC IN connector

Connect a 12 V DC power supply.

When the voltage drops to approximately 10.0 V, the unit is shutdown automatically.

Afterwards, the power is not restored automatically even if the power supply voltage recovers. Press and hold the [⏻/|] button for at least 1 second to turn the power on.

◆ Note:

When using an external DC power supply, be sure to check the external DC power supply ratings and use one that is suitable for the unit.

Check the pin assignment of the DC output connector of the external DC power supply and the DC IN connector on the unit, and connect the connectors with the correct polarity. Incorrect connection of the +12 V power supply to the GND connector may cause a fire or injury.

Preparation

Power Supply

A battery or the supplied AC adaptor can be used as the power supply for the camera.

- The camera is compatible to following batteries. (As of April 2019)
 - AG-VBR59 (supplied/optional, supports quick charging)
 - AG-VBR89 (optional, supports quick charging)
 - AG-VBR118 (optional, supports quick charging)
 - VW-VBD55 (optional: end of sale)
 - VW-VBD58 (optional)

Charging the Battery

The battery is not charged at the time of purchase. Fully charge the battery in the battery charger before using the battery. It is recommended that you have one extra battery.

- It is recommended to perform charging of the battery in a location with ambient temperature of 10 °C to 30 °C (same for the battery temperature).
- The supplied AC cable is dedicated for this camera. Do not use with any other device. Also, do not use AC cable from other device on this camera.
- The supplied battery charger can simultaneously charge two batteries. Also, it is compatible with the quick charge battery.

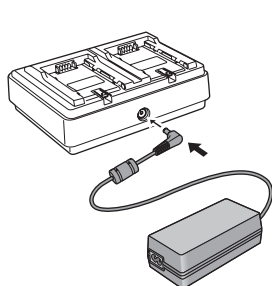

Fig. 1

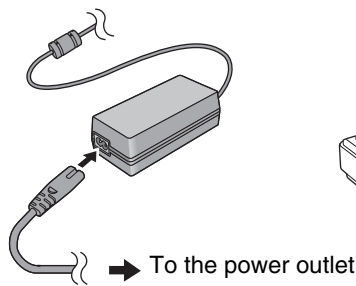

Fig. 2

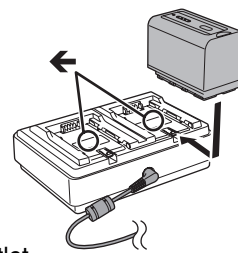

Fig. 3

1 Connect the DC plug of the AC adaptor to the DC IN 12V terminal of the battery charger. (Fig. 1)

2 Connect the AC cable to the AC adaptor. (Fig. 2)

- Insert the AC cable all the way in until it stops.

3 Connect the power plug to the power outlet. (Fig. 2)

4 Mount the battery to the battery charger. (Fig. 3)

The charging lamp of the side the mounted battery will illuminate, and the charging will start.

- Place the battery horizontally along the ← mark, and slide it.
- Once the charging is completed, the <CHARGE1>/<CHARGE2> lamp (charging lamp) will turn off. Slide the battery and remove it.

■ Display of the <CHARGE1>/<CHARGE2> lamp

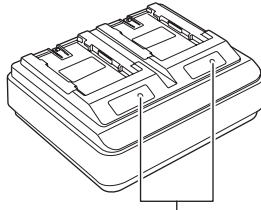

<CHARGE1>/<CHARGE2> lamp

The <CHARGE1>/<CHARGE2> lamp (charging lamp) of the supplied battery charger indicates the charging status as follows.

| Display of the <CHARGE1>/<CHARGE2> lamp | Charging status |
|---|---|
| Green (illuminated) | Quick charging |
| Orange (illuminated) | Normal charging |
| Orange (flashing) | Stopped charging due to an error |
| Off | Charging is completed or the battery is not mounted |

◆ Note:

- The battery charger will determine the status of the battery after the battery is mounted. Therefore, it may take some time until the charging lamp is to illuminate. Mount the battery again if the charging lamp does not illuminate after ten seconds or longer has elapsed.
- When two quick charging compatible batteries are mounted, the quick charging on the <CHARGE1> side will take priority, and the charging on the <CHARGE2> side will be normal charging. Once the charging of the <CHARGE1> side proceeds, the charging on the <CHARGE2> side will switch to quick charging. Also, depending on the charging status of the battery, the indicator on the battery that is mounted on the <CHARGE2> side may turn off.
- The battery charger will perform optimal charging after determining the status of the battery. Once the charging is started, the indicator for quick charging compatible battery will flash. Also, if it is charging on both <CHARGE1> side and <CHARGE2> side, charging of both batteries will stop when either one of the battery is mounted/removed, or replaced. It will start the charging again after determining the status of the batteries.
- Mount the battery to be charged prioritized on the <CHARGE1> side when charging.

■ Charging time and playback time estimates

| Battery model | Voltage/capacity (minimum) | Charging time | Continuous playback time |
|------------------------------|----------------------------|---------------------|--------------------------|
| AG-VBR59 (supplied/optional) | 7.28 V/5900 mAh | Approx. 200 minutes | Approx. 170 minutes |
| AG-VBR89 (optional) | 7.28 V/8850 mAh | Approx. 240 minutes | Approx. 255 minutes |
| AG-VBR118 (optional) | 7.28 V/11800 mAh | Approx. 280 minutes | Approx. 345 minutes |
| VW-VBD55 (optional) | 7.2 V/5400 mAh | Approx. 320 minutes | Approx. 160 minutes |
| VW-VBD58 (optional) | 7.2 V/5800 mAh | Approx. 320 minutes | Approx. 170 minutes |

- The charging time is the time when charged using the supplied battery charger.
- The charging time is the time when the operating ambient temperature is 25 °C and operating relative humidity is 60%. At other temperature and humidity the charging time may take longer.
- The charging time is the time to charge when the charging capacity of the battery is used up. The charging time or the continuous playable time differs depending on the use condition such as high or low temperature.

◆ Note:

- Battery is warm after using or after charging, but this is not a malfunction.
- The battery can be charged with the battery charger AG-B23 (DE-A88) (optional), but it will take longer to charge.

Using the Battery

Installation

- 1 Slide the battery until it clicks into place.

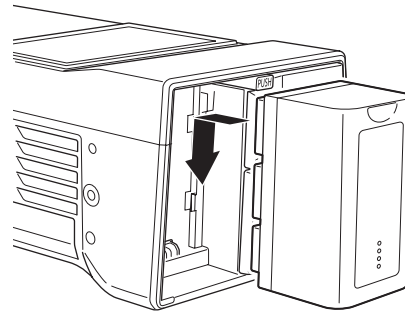

Removal

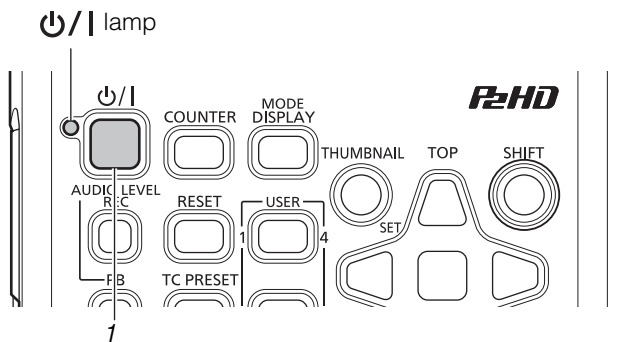

◆ **Note:**

If the power is on, be sure to turn it off before removing the battery.

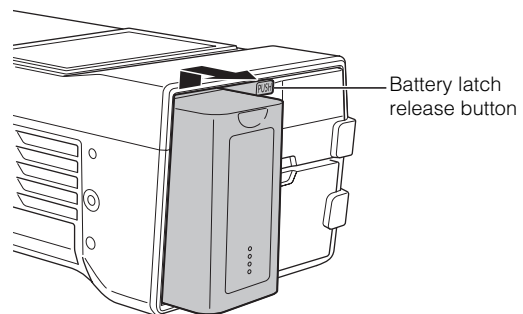

- 1 Press the [Power/I] button for two seconds to turn the power off, and confirm that the Power/I lamp has turned off.
- 2 Remove the battery while pressing the battery latch release button.
Support the battery with a hand to prevent it from falling.

Using the AC Adaptor

Installation

- 1** Connect the AC cable.
Connect the AC cable in the order indicated in the figure.

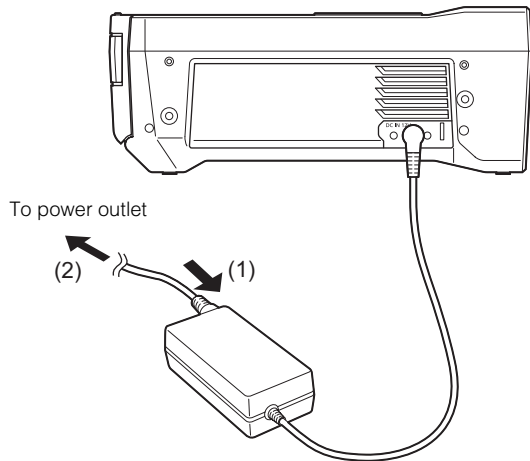

- 2** Insert the DC power cable plug into the DC IN connector.

- 3** Clamp the DC cord.

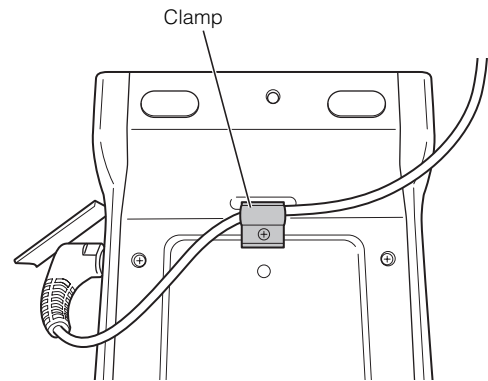

Removal

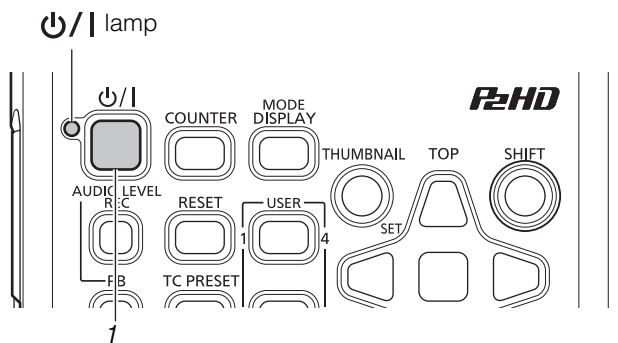

- 1** Press the [power icon / |] button for two seconds to turn the power off, and confirm that the power icon / | lamp has turned off.

- 2** Remove the DC power cable plug.

◆ **Note:**

If the power is on, be sure to turn it off before removing the DC power cable plug.

- 3** Disconnect the AC cable (for the AC adaptor) from the power outlet.

◆ **Note:**

- The AC adaptor is designed to operate with all power supply voltages (100 V to 240 V) and frequencies (50 Hz/60 Hz) around the world. However, the shape of the power outlet differs depending on the country. Use a plug that is designed for the country of use. If necessary, contact your supplier to obtain the appropriate plug adaptor.
- When you will not use the unit, disconnect the AC cable (for the AC adaptor) from the power outlet.

How to Turn On/Off the Power

Turning On the Power

From the power-off state, press the [⏻/⏻] button for one second to turn the power on. After startup, the ⏻/⏻ lamp lights green.

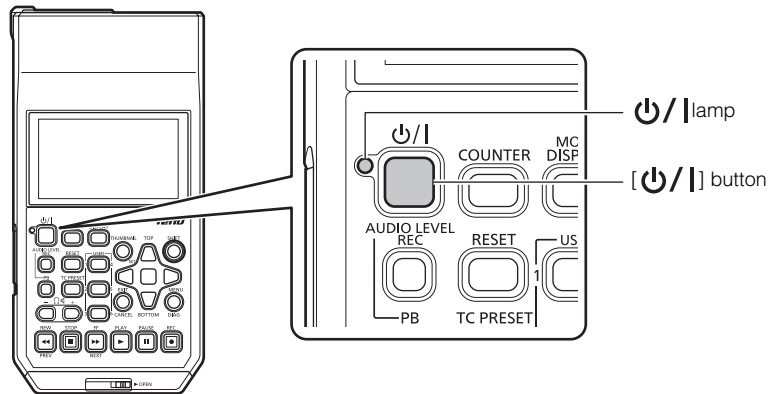

◆ Note:

The following messages appear during startup.

- "STARTING SYSTEM...": Flashes during startup.
- "AUTO POWER OFF = * min": The time set in the "AUTO POWER OFF" (→ page 102) menu item is displayed instead of "*." When the menu item setting is set to OFF, this message is not displayed.



Turning Off the Power

From the power-on state, press the [⏻/⏻] button for at least two seconds to turn off the power. The ⏻/⏻ lamp flashes during the power-off process, and then turns off.

Auto Power Off during Operation

The unit has a function to automatically turn the power off after a short period of time if no operation such as recording, playback, copying, or formatting is performed during that time. To resume operation after the power turns off automatically, turn the power on again.

◆ Note:

The time until the power turns off can be set in the "AUTO POWER OFF" (→ page 102) menu item.

Setting the Year, Month, Day, and Time

Set the clock before using the unit the first time.

1 Press the [⏻/] button on the unit for one second to turn the power on.

2 Press the [MENU] button to display the menu. (→ “Menu Operations” page 89)

3 Use the cursor buttons to select the “CLOCK” (→ page 102) menu item and then press the [SET] button. The clock setting screen appears. The default values are the current time settings.



4 Use the left and right cursor buttons to select the digits to be set.

- Display is in the order of hour/minute/month/day/year/ time zone.
- For the time zone, set the difference in hours from Greenwich Mean Time.
- The time is displayed in the 24-hour format.

5 Use the up and down cursor buttons to set the year, month, day, time, and time zone.

6 After configuring the settings, press the [SET] button.

Pressing the [SET] button sets the clock to the changed time.

◆ **Note:**

- The clock is affected by deviation so check that the time is correct before use.
- When an accurate time is required, check and reset the time before use.

■ **Time zone**

| Time difference | Area | Time difference | Area |
|-----------------|---------------------|-----------------|------------------|
| 00:00 | Greenwich | +01:00 | Central Europe |
| -00:30 | | +01:30 | |
| -01:00 | Azores Islands | +02:00 | Eastern Europe |
| -01:30 | | +02:30 | |
| -02:00 | Mid-Atlantic | +03:00 | Moscow |
| -02:30 | | +03:30 | Tehran |
| -03:00 | Buenos Aires | +04:00 | Abu Dhabi |
| -03:30 | Newfoundland Island | +04:30 | Kabul |
| -04:00 | Halifax | +05:00 | Islamabad |
| -04:30 | Caracas | +05:30 | Mumbai |
| -05:00 | New York | +06:00 | Dacca |
| -05:30 | | +06:30 | Yangon |
| -06:00 | Chicago | +07:00 | Bangkok |
| -06:30 | | +07:30 | |
| -07:00 | Denver | +08:00 | Beijing |
| -07:30 | | +08:30 | |
| -08:00 | Los Angeles | +09:00 | Tokyo |
| -08:30 | | +09:30 | Darwin |
| -09:00 | Alaska | +10:00 | Guam |
| -09:30 | Marquesas Islands | +10:30 | Lord Howe Island |
| -10:00 | Hawaii | +11:00 | Solomon Islands |
| -10:30 | | +11:30 | |
| -11:00 | Midway Island | +12:00 | New Zealand |
| -11:30 | | +12:45 | Chatham Islands |
| -12:00 | Kwajalein | +13:00 | Phoenix Islands |
| +00:30 | | | |

■ **About the battery of the internal clock**

If the battery of the internal clock is empty because, for example, power has not been supplied for a long period of time, the “BACKUP BATT EMPTY” warning will be displayed. If that happens, connect the AC adaptor and then leave the unit for approximately 4 hours to charge the battery. If the “BACKUP BATT EMPTY” warning is displayed after charging, the internal battery needs to be replaced. Ask your dealer to replace the battery.

P2 Cards

P2 Card Access Lamp and P2 Card Status

| P2 Card Access Lamp | P2 Card Status | |
|----------------------|----------------------------------|---|
| Lights green | Recording possible | Both writing and reading are possible. |
| Lights orange | Recording target | Writing and reading are enabled and currently recording target. |
| Flashing orange | Card being accessed | Writing or reading is in progress. |
| Fast flashing orange | Card being recognized | The P2 card is being recognized. |
| Slow flashing green | Card full | There is no available space on the P2 card. Only reading is possible. |
| | Write protected | The write-protect switch on the P2 card is set to Protect. Only reading is possible. |
| | Card not supported for recording | Recording is not possible with the currently set recording format because an SD memory card or other unsupported card is inserted. Only reading is possible. To record, change the recording format or use a P2 card. |
| | Slot not target for recording | A card has been inserted in a different slot from that of "REC MEDIA" (microP2/P2) (→ page 98) menu item. |
| Off | Card not supported | The card cannot be used with the unit. Replace the card. |
| | Format invalid | The P2 card is not formatted properly. Reformat it. |
| | No card | A P2 card is not inserted. Waiting for the card to be recognized. |
| | Card cannot be authenticated | A microP2 memory card for which authentication is not possible. Refer to "Manual and Automatic CPS Authentication" (→ page 55) and then perform authentication. |
| | No USB access | The P2 card is not accessible using USB device mode. |

◆ Note:

"FORMAT ERROR!", "NOT SUPPORTED!" or "CHECK SLOT <slot number>" may appear if a microP2 memory card is inserted too slowly or if its terminals are not clean. Should this happen, reinsert it.

P2 Card Recording Times

P2 cards supported by the unit

The unit supports separately sold P2 memory cards and microP2 memory cards of 4 GB to 64 GB. (As of December 2014)

◆ Note:

- When AVC-Intra100 of 1080/59.94p and 1080/50p is selected or when AVC-Intra200 is selected regardless of the "LINE&FREQ" setting, recording to the following P2 cards is not possible.
 - H, R, A, and E series P2 memory cards.
 - Card attached to microP2 card adaptor (AJ-P2AD1G)
- AJ-P2C002SG (2 GB) cards cannot be used.
- The unit may need to be updated depending on the type of P2 card.
- For the latest information not available in the Operating Instructions, visit the website. (→ "Website URL" page 9)

P2 card recording times

(Example of using one 64 GB card)

| "LINE&FREQ" setting (recording format) | "REC FORMAT" setting (codec) | Recording duration |
|--|------------------------------|---------------------|
| 1080-59.94P, 1080-50P | AVC-I100 | Approx. 32 minutes |
| | AVC-G25 | Approx. 110 minutes |
| 1080-59.94i, 1080-50i | AVC-I100 | Approx. 64 minutes |
| | AVC-G25 | Approx. 220 minutes |
| 720-59.94P, 720-50P | AVC-I100 | Approx. 64 minutes |
| | AVC-G25 | Approx. 220 minutes |
| 480-59.94i, 576-50i | DVCPRO50 | Approx. 128 minutes |
| | DVCPRO | Approx. 256 minutes |

◆ Note:

- The recording times for 32 GB, 16 GB, and 8 GB P2 cards are 1/2, 1/4, and 1/8th of those shown above, respectively.
- The displayed sizes include the management area, for example, so the amount of space available for recording will be less than the above.

Dividing of clips recorded to P2 cards

When an 8 GB or larger P2 card is used with the unit, continuous recordings longer than the durations shown in the table below result in automatic division of the recording into multiple clips.

| Recording formats (excluding native recording) | Continuous recording duration |
|--|-------------------------------|
| AVC-I200, AVC-I100 (1080p) | Approx. 3 minutes |
| AVC-I100 (1080i), DVCPRO HD | Approx. 5 minutes |
| AVC-G50, AVC-I50, DVCPRO50 | Approx. 10 minutes |
| AVC-G25, DVCPRO, DV | Approx. 20 minutes |

Also, you can enable a clip that is recorded to be split every approximately 128 seconds in the "FILE SPLIT" menu item (→ page 98). The timing of clip transfer can be made earlier by using the rec during upload function with this split function. When clip thumbnail operations (display, delete, repair, etc.) are performed on a P2 device, the split clips are also handled as a single clip. However, the split clips may be displayed as separate clips in nonlinear editing software or on a PC or other device.

When recording to a microP2 memory card exceeding 32 GB using the AVC-LongG codec, you can enable continuous recording as the same clip in the "FILE SPLIT" (→ page 98) menu item.

Recording in which the same clip exceeds 4 GB is possible, but copying to storage using the usb-host mode of the unit will not be possible.

Furthermore, you will not be able to copy the clip if the maximum size of one file is restricted to, for example, 4 GB by the format (NTFS, FAT32, etc.) of the storage of the computer or other device, so configure the settings to match your environment.

◆ Note:

When a clip is recorded by splitting it every approximately 128 seconds, recording is possible only for a maximum of 213 minutes.

Content Protection System (CPS)

microP2 memory cards support the content protection system (CPS), which is a security function that prevents data leakage to third parties by recording in an encrypted format.

To use the CPS function, you need to set a CPS password and enable the microP2 memory card authentication function (→ "Manual and Automatic CPS Authentication" page 55) and encrypted format function (→ "Formatting P2 Cards and SD Memory Cards" page 54) on the unit. microP2 memory cards in an encrypted format are authenticated automatically to enable use as microP2 memory cards for recording and playback only on devices for which the same CPS password is set. For details on CPS passwords, refer to "Manual and Automatic CPS Authentication" (→ page 55).

◆ Note:

- Up to 16 characters can be set for the password.
- An encrypted microP2 memory card cannot be recognized in an SD slot of a computer.
- If an authentication error occurs, perform authentication again with the correct password, format the card to enable use as storage media, or eject it from the device. Do not perform any operation other than manual authentication or formatting while a card for which an authentication error has occurred is inserted.
- To access an encrypted microP2 memory card from a computer when in USB device mode, perform authentication for the microP2 memory card with P2 Viewer Plus.

Handling of Recording Data

P2 memory cards and microP2 memory cards are semiconductor memory cards designed for the P2 series, Panasonic's line of professional video and broadcast equipment.

■ Recording data in the P2 format is ideally suited for computer processing because it is a file format. The file structure includes not only video and audio data recorded in the unique MXF file format but also various important information, and has the folder configuration shown on the right.

If any of this data is changed or deleted, a problem may occur, such as the data being unable to be recognized as P2 data or the card no longer being able to be used in a P2 device.

■ A P2 card that has been formatted in other than a microP2 memory card compatible device will not contain the AVCLIP folder. For a P2 card without an AVCLIP folder, the folder will be created automatically when recording is performed on a microP2 memory card compatible device.

■ To prevent data loss when transferring the data on a P2 card to a computer or other device or when writing the data stored on a computer back to a P2 card, be sure to use the dedicated P2 Viewer Plus software, which can be downloaded from the Panasonic website. For the URL, refer to (→ "Website URL" page 9)

■ When transferring data to a computer using a general IT tool such as Microsoft Windows Explorer or Apple Finder, observe the following. Be sure to use P2 Viewer Plus to write the data back to a P2 card.

- Process the CONTENTS folder and the LASTCLIP.TXT file together.
Do not modify any data under the CONTENTS folder.
When copying the data, be sure to copy both the CONTENTS folder and the LASTCLIP.TXT file together.
- When transferring the data from multiple P2 cards to a computer, create a separate folder for each P2 card to prevent the overwriting of clips with identical names.
- Do not delete data on a P2 card.
- Be sure to use a P2 device or P2 Viewer Plus to format P2 cards.

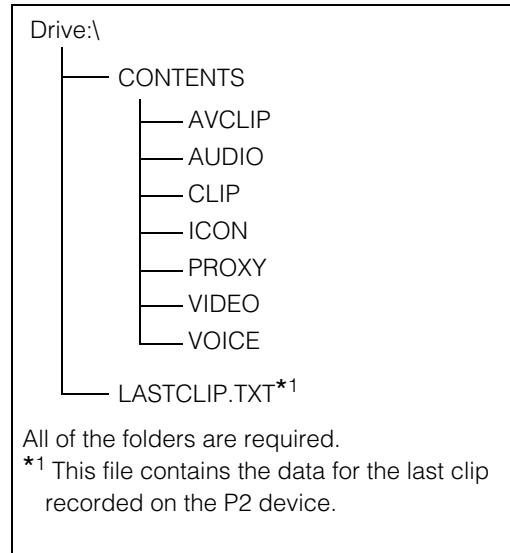

Using SD/SDHC/SDXC Memory Cards

Use only SD, SDHC, and SDXC*¹ memory cards that comply with the SD, SDHC, and SDXC*³ standards in the unit. Memory cards other than SD, SDHC, and SDXC cards (for example, MultiMediaCard*²) cannot be used.

*¹ The SDHC memory card is a new card standard (version 2.0), established by the SD Card Association in 2006, for memory cards with capacities exceeding 2 GB.

*² MultiMediaCard (MMC) is a registered trademark of Infineon Technologies AG.

*³ The SDXC memory card is a new standard (version 3.0), established by the SD Card Association in 2009, for memory cards with capacities exceeding 32 GB.

- When using a miniSD, miniSDHC, microSD, microSDHC, or microSDXC card in the unit, be sure to use it with the correct dedicated adaptor attached. (Note that the unit will not operate normally when only an adaptor without a card is inserted.)

- Be sure to use the unit to format cards.

- The unit supports SD, SDHC, and SDXC memory card of the following sizes.

SD: 8 MB to 2 GB

SDHC: 4 GB to 32 GB

SDXC: Over 32 GB

Use of Panasonic SD, SDHC, and SDXC memory cards and miniSD, miniSDHC, microSD, microSDHC, and microSDXC cards is recommended.

- The latest information on supported memory cards is available on our P2 Support website. For the URL, refer to (→ “**Website URL**” page 9)

Available Modes

This unit comes with three modes: Main mode, USB device mode, and playlist editing mode.

You can select or change the mode by selecting one of the menu items displayed when you press the [MODE] button. Main mode has a thumbnail screen for displaying and managing clip thumbnails and playing clips and a recording/playback screen for recording and playback.

The figure below shows an overview of each mode.

- **Recording/playback screen:** Displays video, time code, and other information and enables recording and playback.
- **Thumbnail screen:** Displays clip thumbnails, various properties, and other information and enables the management and playback of clips.

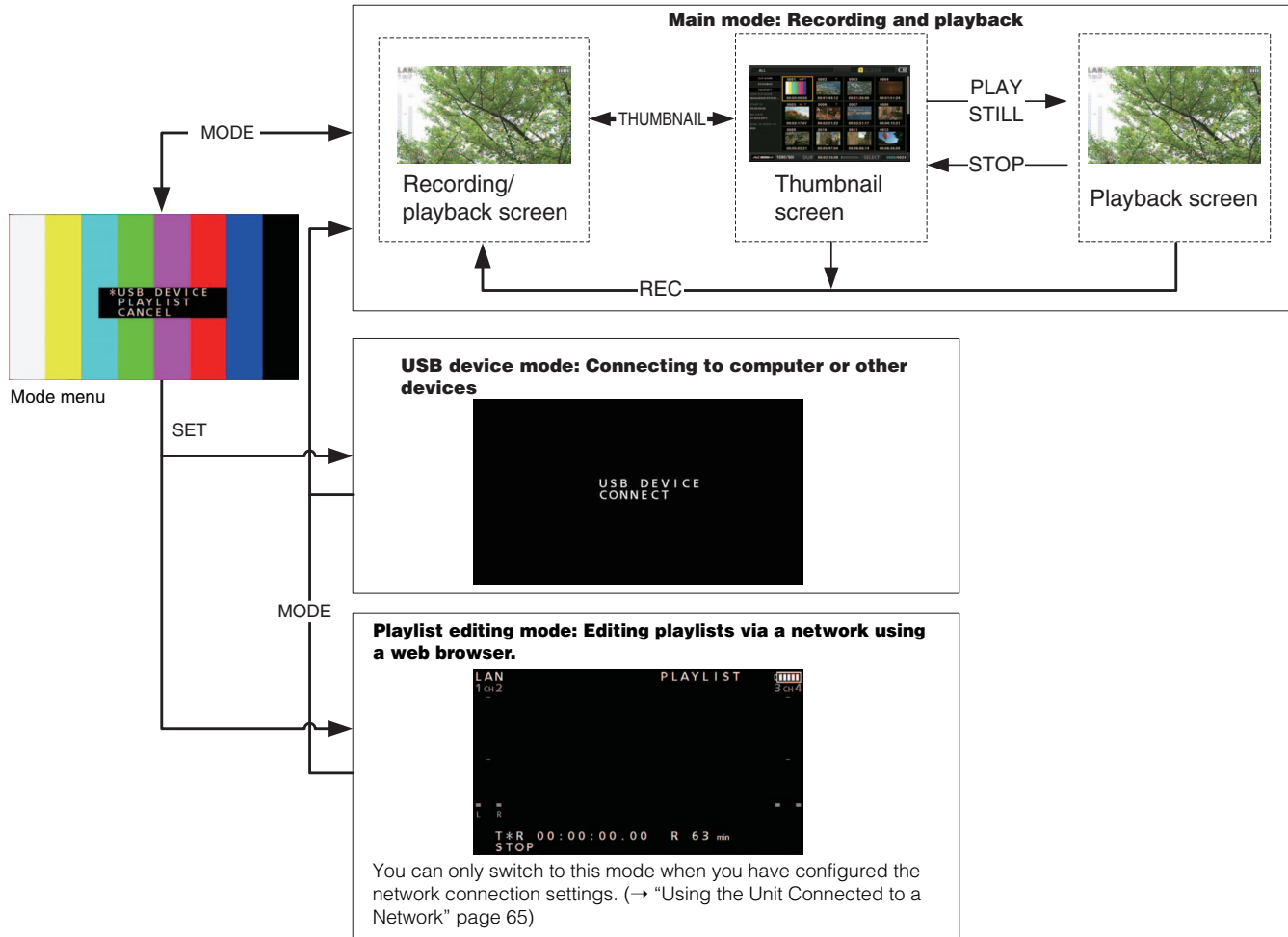

Main Mode

Recording/Playback Screen

Use the recording/playback screen for the following.

- Recording to P2 cards
- Playing back all cards in the order they were recorded

Recording Clips

Record audio and video as clips.

Recording clips

Before you start recording, set the recording frequency, format, slot for recording, input signal, and other settings in the menu.

(→ Setup Menu “SYSTEM MODE” page 114, “REC/PB” page 97)

◆ Note:

If analog is selected for audio input, a 4-channel audio file will be created but no sound will be recorded on any channel other than channels 1 and 2.

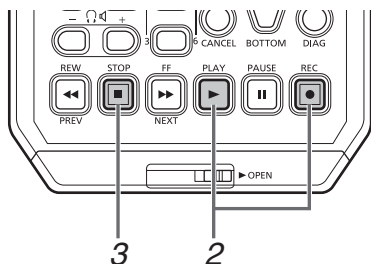

1 Insert a P2 card.

2 Press the [PLAY]  button while holding down the [REC]  button.

Recording begins on the P2 card in the slot with the access lamp is lit orange.

◆ Note:

Setting the “CODEC USAGE” (→ page 99) menu item to “PROXY REC(P2)” or “PROXY REC(P2&SD)” and then recording will start proxy recording simultaneously with the recording of the main material. (→ “Dual codec (proxy) recording” page 33)

3 Press the [STOP]  button to stop recording.

◆ Note:

Recording to a mixture of the P2 memory card slots (3) and microP2 memory cards slots (1 and 2) is not possible. Select the recording target slots in the “REC MEDIA” (→ page 98) menu item.

■ Adjusting the recording audio levels

Follow the procedure below to change the volume level for recording.

1. Press the [AUDIO LEVEL-REC] button.

The recording volume appears.

2. Operate the up or down cursor button.

3. Use the left or right cursor button to select an audio channel.

The selected channel number flashes. Each of the channels can be adjusted.

4. After adjustment is finished, press the [AUDIO LEVEL - REC] button, [SET] button or [EXIT] button.

The setting values are saved and the displayed information disappears.

◆ Note:

- The setting values do not change when you turn off the power.
- If you press the [RESET] button during the changing of the audio levels, the level of the selected channel is restored to the default value.

■ Changing the recording slot

With the microP2 card slots, the recording target slot can be changed during recording or when recording is stopped.

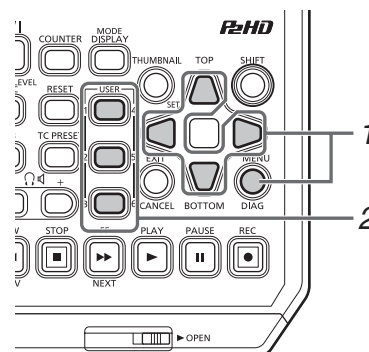

1. Assign the SLOT SEL function to a [USER] button in the “USER BUTTON” (→ page 110) menu item.

2. Press the [USER] button during recording or when recording is stopped.

The recording slot changes with each press of the button.

◆ Note:

- When you do not perform SLOT SELECT right after switching the recording target P2 card, “SLOT SEL INVALID” will appear on the third line of the OSD if the “OSD TC SELECT” (→ page 108) menu item is set to “T&S&M.”
- The slots can be switched with the SLOT SEL function only when “microP2” is selected in the “REC MEDIA” (→ page 98) menu item.

Various types of recording

■ Hot swap recording

When P2 cards are inserted in both of the microP2 memory card slots, continuous recording spanning both cards is possible. You can also record continuously on three or more cards (hot swap recording) by replacing one card while recording on the other.

◆ Note:

- P2 card recognition may be delayed and prevent hot swap recording depending on the timing at which a P2 card is inserted in the empty slot (immediately prior to or after recording continues onto the other card).

It is recommended to insert a P2 card when there is still at least 1 minute of time left on the card currently being used for recording.

- The unit does not support hot-swapping during playback.

■ LOOP REC

LOOP REC is a function for recording continuously while successively switching the card target for recording when two P2 cards are inserted in the microP2 memory card slots. Recording can be performed continuously by returning to the first card when the available space on the P2 cards has been used up and then overwriting the old recording with the new recording.

To use the LOOP REC function, select "LOOP" in the "RECORDING" (→ page 97) menu item.

◆ Note:

- The LOOP REC function can only be used with microP2 memory cards. It cannot be used with P2 memory cards.
- Use P2 cards with at least one minute of free space for loop recording.
- During loop recording, all of the P2 card access lamps for the P2 cards used for recording are lit orange. Note that removing any of the P2 cards will stop loop recording.

When "LOOP" is selected in the "RECORDING" menu item

- "LOOP" is displayed on the second line of the OSD. However, even when "LOOP" is selected in "RECORDING," the loop recording will not work if only one card is inserted or the remaining recording time on a card is less than 1 minute. Should this happen, "LOOP" will flash on the OSD.
- The remaining space of P2 cards is indicated as the standard guaranteed recording time according to the recording format. When loop recording is stopped right after deleting old data, the actual remaining time may be shorter than indicated.
- Proxy recording cannot be performed.

During loop recording



- Shot marks cannot be added or deleted. Also, text memos cannot be added.

Canceling loop recording mode

- Select "NORMAL" in the "RECORDING" menu item.

■ AUTO REC

When a camera compatible with the function is connected via HD SDI or HDMI, starting and stopping recording on the unit can be automatically controlled using the REC START / STOP function on the camera.

1. Match the "AUTO REC" (→ page 97) menu item to the camera to be used.
2. Press the [REC]  button and [PAUSE]  button on the unit simultaneously to switch to REC PAUSE mode.

Now you can start and stop recording on the unit using the REC START / STOP function on the camera.

◆ Note:

There may be a delay in the recording start and stop operations on the unit in relation to those of the camera, and complete accuracy is not guaranteed.

■ SIMUL REC

This is a function for recording the same images to two P2 cards when two P2 cards are inserted in the microP2 memory card slots.

To use the SIMUL REC function, select "ON" in the "SIMUL REC" (→ page 97) menu item.

◆ Note:

- The remaining amount of time (of the memory card with less remaining space) for SIMUL REC will be displayed for the remaining space indication of the media.
- SIMUL REC will stop if either of the P2 cards in the respective slots runs out of space.
- SIMUL REC will not be possible if "1080-59.94P" or "1080-50P" is selected in the "LINE&FREQ" (→ page 114) menu setting.
- If a recording error occurs and causes recording to stop on one of the P2 cards during SIMUL REC, recording will continue on the other P2 card. However, recording will end if a card is removed while it is being accessed.
- Make sure both P2 cards are recognized before starting recording. If you start recording before both P2 cards are recognized, normal recording will be performed on the one card that was recognized. The card status is checked when recording is complete. If two cards are recognized at that time, SIMUL REC will be performed.

When "ON" is selected in the "SIMUL REC" menu item

- "SIMUL" is displayed on the second line of the OSD. Even if "SIMUL REC" is set to "ON", however, SIMUL REC will not function if one of the cards is not inserted. Should this happen, "SIMUL" will flash on the OSD.
- If you press the record button while "SIMUL" is flashing, normal recording will be performed on the card with remaining space.

Canceling SIMUL REC mode

- Select "OFF" in the "SIMUL REC" menu item.



Dual codec (proxy) recording

Simultaneously record video as well as time-code data and other real-time data in H.264 format to a P2 card or SD memory card separately from the main video and audio material recorded with the unit.
(→ “DUAL CODEC SETUP” page 99 menu item)

■ Recording modes and recording signals (video and audio)

| Recording mode | Video | | | Audio | | |
|----------------|---|---------------------------|-----------|------------|--------------------|----------------------|
| | Resolution | Codec | Bit rate | Codec | Number of channels | Bit rate per channel |
| LOW 2CH MOV | 1080i mode 480 x 270 1080 59.94/50p mode 320 x 180 | H.264 Baseline Profile | 800 kbps | AAC-LC | 2 channels | 64 kbps |
| HQ 2CH MOV | 640 x 360 | H.264 High Profile | 1500 kbps | AAC-LC | 2 channels | 64 kbps |
| SHQ 2CH MOV | 960 x 540 | H.264 High Profile | 3500 kbps | Linear PCM | 2 channels | 768 kbps |
| AVC-G6 2CH MOV | 1920 x 1080 | H.264 High Profile | 6 Mbps | AAC-LC | 2 channels | 64 kbps |

■ Recording proxy data

Set the “CODEC USAGE” (→ page 99) menu item to “PROXY REC(P2)” or “PROXY REC(P2&SD)” and then press the [PLAY]  button while holding down the [REC]  button to start proxy recording simultaneously with the recording of the main material.

- You can check detailed information on the recorded proxy data from the properties of the clip.
(→ “Viewing the clip metadata information” page 50)
- Proxy data is recorded to a P2 card or SD memory card as a video and audio file and a real-time data file.
Video and audio file: *****.MOV
Real-time metadata file: *****.BIN
The time code, user bits, and other information are recorded on a frame basis.

- When the number of clips becomes 1,000 or more, proxy data cannot be recorded to the SD memory card even if there is free space remaining. Check the number of clips recorded to the SD memory card in “NUMBER OF CLIP” of the “SD CARD PROPERITY” (→ page 111) menu item.
- Shot marks and text memos cannot be added to clips in an SD memory card.
- Even if you delete the clips recorded to the P2 card in the thumbnail screen, the proxy data recorded to the SD memory card will not be deleted.

■ Checking proxy data

- The  indicator is displayed for a clip of material for which proxy data recording was performed.
- Check the proxy data in P2 Viewer Plus. The data may not be able to be checked depending on the version of P2 Viewer Plus. For information on P2 Viewer Plus, visit the Panasonic website. (→ “Website URL” page 9)
- Proxy data cannot be played with the unit.

◆ Note:

- Dual codec recording is not possible in the following modes.
 - LOOP REC
 - SIMUL REC
 - 480-59.94i or 576-50i
 - AVC-I200
- When “1080-59.94p” or “1080-50p” is set for the “LINE&FREQ” (→ page 114) menu setting, recording is not possible.
- “AVC-G6 2CH MOV” cannot be recorded when the “REC FORMAT” menu item (→ page 114) is set to “DVCPRO HD”, “AVC-G12”, or “AVC-I50”.
- When “ONE FILE” is set for the “FILE SPLIT” menu item (→ page 98), recording is not possible.
- To record the proxy data, use SD, SDHC, or SDXC memory cards with an indication of class 2 or higher. If the recording format of the proxy data is “SHQ 2CH MOV” or “AVC-G6 2CH MOV”, use a card of class 4 or higher.
- The SD memory card access lamp lights green during the recording of proxy data to the SD memory card.
- If short recordings are repeated, the available recording time may decrease significantly compared to the available space.

Streaming function

You can perform live streaming of audio and video from the unit over the network (wired LAN, wireless LAN, 4G/LTE). Streaming video from the unit or an application software (e.g. P2 Browser, P2 Streaming Receiver) of a device connected to the unit through a network is transmitted to a server capable of receiving such signal.

There are two ways to start streaming: streaming from an application software and streaming from the unit.

◆ Note:

To display the streaming video in the P2 Browser, start the streaming distribution by operation from the application software. The streaming video cannot be displayed when operated from the unit.

Setting the network connection

The network settings of the unit are configured according to the settings of application software.

1 Set the network connection method.

Select the network connection method in the "NETWORK SEL" menu item (→ page 105).

2 Configure the various settings of the network.

• When configuring the settings in a menu of the unit

Configure the various settings of the network connection in the "NETWORK" menu item (→ page 105). For details, refer to "Network Connection" (→ page 65).

• When configuring the settings by referring directly to setting values in an SD memory card

Configure the settings by referring directly to setting values in an SD memory card without saving them to the unit.

- 1) Select "SD CARD" in the "SETTING DATA" menu item (→ page 106) on the unit side.
- 2) Insert an SD memory card in which the setting values have been saved beforehand and then turn on the power of the camera.

◆ Note:

The setting values of the SD memory card can be saved as described below.

- Select "SAVE(SD CARD)" in the "STREAMING SETTING" menu item (→ page 106).
- Save the settings to the SD card using an application, etc.

• When saving the setting values in an SD memory card to the unit and then configuring the settings

- 1) Select "INTERNAL" in the "SETTING DATA" menu item (→ page 106).
- 2) Insert the SD memory card in which the setting values have been saved and then select "LOAD(SD CARD)" in the "STREAMING SETTING" menu item (→ page 106).

Using the streaming function

After you finish configuring the network connection, you can configure the streaming function.

1 Select "STREAMING" in the "CODEC USAGE" menu item (→ page 99).

Streaming function is enabled.

2 Set the streaming mode in the "STREAMING MODE" menu item (→ page 99).

- Select either "LOW", "HQ", "AVC-G6", "SHQ (QoS)", or "AVC-G (QoS)".
- For details on combinations of system modes and streaming modes, refer to the table in "List of system modes and supported streaming output" (→ page 36).

3 Set the method for starting streaming.

• When starting streaming through operation from an application software

Select "RECEIVER" in the menu "START TRIGGER" (→ page 106).

• When starting streaming through operation from the camera

- 1) Select "AJ-PG50" in the menu "START TRIGGER" (→ page 106).
- 2) Perform following setting when the streaming mode is set to "SHQ (QoS)" or "AVC-G (QoS)" in Step 2.
 - Set the menu "QoS MAX RATE" (→ page 99) and "QoS MIN RATE" (→ page 99).
 - Set the delay mode during live streaming in the menu "STREAMING LATENCY" (→ page 99).
Set "NORMAL" if you want to place emphasis on streaming stability and "SHORT" if you want to place emphasis on the reduction of streaming delay.

4 Start streaming.

- **When starting streaming through operation from an application software**

If you started streaming using an application software, the unit starts the transmission of streaming video.

- **When starting streaming through operation from the unit**

Select "START" in the menu "STREAMING" (→ page 106).

If the unit is connected to the transmission destination through a network, start the transmission of streaming video.

To stop the transmission of streaming video, select "STOP" in the menu "STREAMING" (→ page 106).

◆ Note:

- To display streaming video using the P2 Browser, VLC Media Player is required for Windows OS and QuickTime Player is required for Mac OS.
However, the P2 Browser does not support the QoS function.
- For details on downloading the video streaming-compatible application software and the operating environment, visit the support desk at the following website:
<https://pro-av.panasonic.net/>
- The streaming function cannot be used together with the dual codec recording and simultaneous recording.
- The streaming function cannot be used together with the recording during upload function.
- If available bandwidth of the network is low and streaming playback is interrupted, this can be improved by selecting a lower bitrate mode in "STREAMING MODE", or selecting either "SHQ (QoS)" or "AVC-G (QoS)". In addition, if "SHQ (QoS)" or "AVC-G (QoS)" is selected, the terminal that receives streaming data needs to support the QoS function.
- The streaming distribution video from the unit will be a black screen in the playback mode (including the recording check).
- If the "INPUT SEL" menu item (→ page 104) is switched during streaming distribution, streaming distribution may stop.
- If the input signal becomes disrupted during streaming distribution, streaming distribution may stop.

List of system modes and supported streaming output

The following shows the relationship between system modes and streaming modes on this unit.

• “✓” are supported, and “-” are not supported.

| SYSTEM MODE | | STREAMING MODE | |
|-------------|--------------|-------------------------------------|------------------------------------|
| LINE&FREQ | REC FORMAT | HD streaming AVC-G6, AVC-G (QoS) | SD streaming HQ, LOW, SHQ (QoS) |
| 1080-59.94i | AVC-I100/60i | ✓ | ✓ |
| | AVC-I50/60i | - | ✓ |
| | AVC-G50/60i | ✓ | ✓ |
| | AVC-G25/60i | ✓ | ✓ |
| 1080-50i | AVC-I100/50i | ✓ | ✓ |
| | AVC-I50/50i | - | ✓ |
| | AVC-G50/50i | ✓ | ✓ |
| | AVC-G25/50i | ✓ | ✓ |
| 720-59.94P | AVC-I100/60P | ✓ | ✓*1 |
| | AVC-I50/60P | - | ✓*1 |
| | AVC-G50/60P | ✓ | ✓*1 |
| | AVC-G25/60P | ✓ | ✓*1 |
| 720-50P | AVC-I100/50P | ✓ | ✓*1 |
| | AVC-I50/50P | - | ✓*1 |
| | AVC-G50/50P | ✓ | ✓*1 |
| | AVC-G25/50P | ✓ | ✓*1 |

*1 “LOW” cannot be selected.

List of streaming modes and resolution/frame rates

| Streaming mode | Resolution | Codec | Frame rate | Bit rate |
|----------------|-------------|--|---------------|---|
| AVC-G6 | 1920×1080*1 | Video: H.264 High Profile Audio: AAC-LC 2ch | 30 fps/25 fps | 6 Mbps |
| | 1280×720*2 | | 60 fps/50 fps | |
| HQ | 640×360 | | 30 fps/25 fps | 1500 kbps |
| LOW | 480×270 | Video: H.264 Baseline Profile Audio: AAC-LC 2ch | 30 fps/25 fps | 800 kbps |
| AVC-G (QoS) | 1920×1080*1 | Video: H.264 High Profile Audio: AAC-LC 2ch | 30 fps/25 fps | Receiving side: Variable depending on the application Maximum 9 Mbps |
| | 1280×720*2 | | 60 fps/50 fps | |
| SHQ (QoS) | 960×540 | Video: H.264 High Profile Audio: AAC-LC 2ch | 30 fps/25 fps | Receiving side: Variable depending on the application Maximum 6 Mbps |

*1 When [LINE&FREQ] is [1080-59.94i] or [1080-50i]

*2 When [LINE&FREQ] is [720-60P] or [720-50P]

Playing Back Clips

Playback

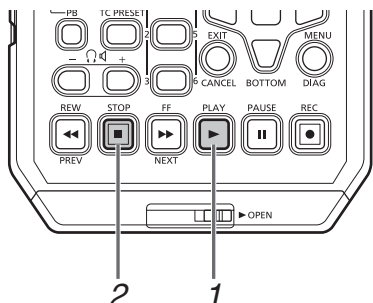

Before you start playback, set the playback frequency, format, and other settings in the menu. (→ Setup Menu “SYSTEM MODE” page 114)



1 Press the [PLAY] button.

Playback begins. Clips play back in the order they were recorded.

◆ Note:

- Pressing the [REW]  button instead of the [PLAY]  button rewinds playback, while pressing the [FF]  button fast forwards playback.
- When clips in different compression formats are played back, the video and audio between clips may be distorted.
- When clips with the same video format but different audio bit rates are played back continuously, the audio between clips will be muted.

2 Press the [STOP] button.

Playback stops and the input video (EE) is displayed.

■ Adjusting the playback audio levels

Follow the procedure below to change the playback levels.

1. Press the [AUDIO LEVEL-PB] button.

The playback volume appears.

2. Press the up or down cursor button.

The levels of all channels can be adjusted.

3. Use the left or right cursor button to select an audio channel.

The selected channel number flashes. Each of the channels can be adjusted.

4. After adjustment is finished, press the [AUDIO LEVEL - PB] button or [EXIT] button.

The setting values are saved and the displayed information disappears.

◆ Note:

- The setting values do not change when you turn off the power.
- If you press the [RESET] button during the changing of the audio levels, the level of the selected channel is restored to the default value.

Variable speed playback

The playback speed can be varied to search for a scene.

1 Press the left or right cursor button during playback or STILL.

Playback changes to high-speed or slow and indicated as SHTL +/- speed.

2 Press the left or right cursor button to change playback speed.

- The playback speed changes each time the buttons are pressed. Maximum playback speed depends on the value set by the “SHUTTLE MAX” (→ page 98) menu setting.
- Audio is not played back at speeds faster than 10 times normal speed.
- The right cursor button changes the speed in forward direction and the left cursor button changes the speed in backward direction.
- Press the [STILL/PAUSE] button or [SET] button to pause playback. To return to normal playback, press the [PLAY]  button.
- The pulldown sequence may not be uniform for variable speed playback of native recorded (including x1 speed) video.
- Not all of the frames of a clip recorded in AVC-G format will be played back during reverse playback and fast playback.

Frame-by-frame playback

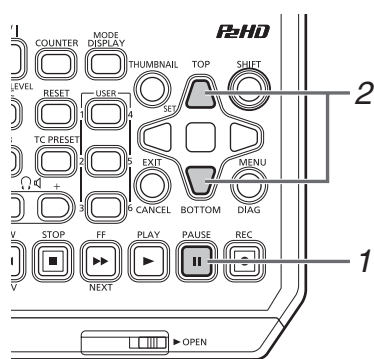

1 Press the [PAUSE]  button to switch to still image mode.

2 Press the up or down cursor button.

- The up cursor button performs frame-by-frame playback in the forward direction and the down cursor button performs frame-by-frame playback in the backward direction.
- Holding down a cursor button performs continuous frame-by-frame playback. To return to normal playback, press the [PLAY]  button.

One clip playback (1 CLIP PLAY)

1 Assign the “1 CLIP PLAY” function to a [USER] button in the “USER BUTTON” (→ page 110) menu.

2 Press the [PAUSE]  button while a thumbnail is displayed or from the thumbnail display screen and then press the [USER] button with “1 CLIP PLAY” assigned when in still image mode.

- Only the clip at the cursor position or current position is played.
- Only STOP is enabled during this playback.

◆ Note:

- One clip playback is also performed when the [PLAY]  button is pressed while holding down the [SHIFT] button.
- If the “1 CLIP PLAY” operation is performed in recording/playback screen mode, one clip playback will not be performed. In that case, the operation will become normal playback.

Clip and text memo forward/rewind

1 Switch to playback or a still image or other image display state.

2 Press the [PREV] button or [NEXT] button.

The clip beginning or text memo position is located in accordance with the "SEEK POS SEL" (→ page 98) menu item.

Overview of all clip playback transitions

This unit allows you to vary audio and video playback speed. The figure below shows speed and transition changes.

Data in boxes: Status and speed

Arrows: Possible direction of transition

Arrow text: Cursor button operation

- Asterisks (*) in the diagram indicate stepwise changes in speed.

Example: Pressing the right cursor button during [PLAY]  results in double speed playback (SHTL + 2.0) and each press of the button increases the speed gradually towards the SHTL MAX setting.

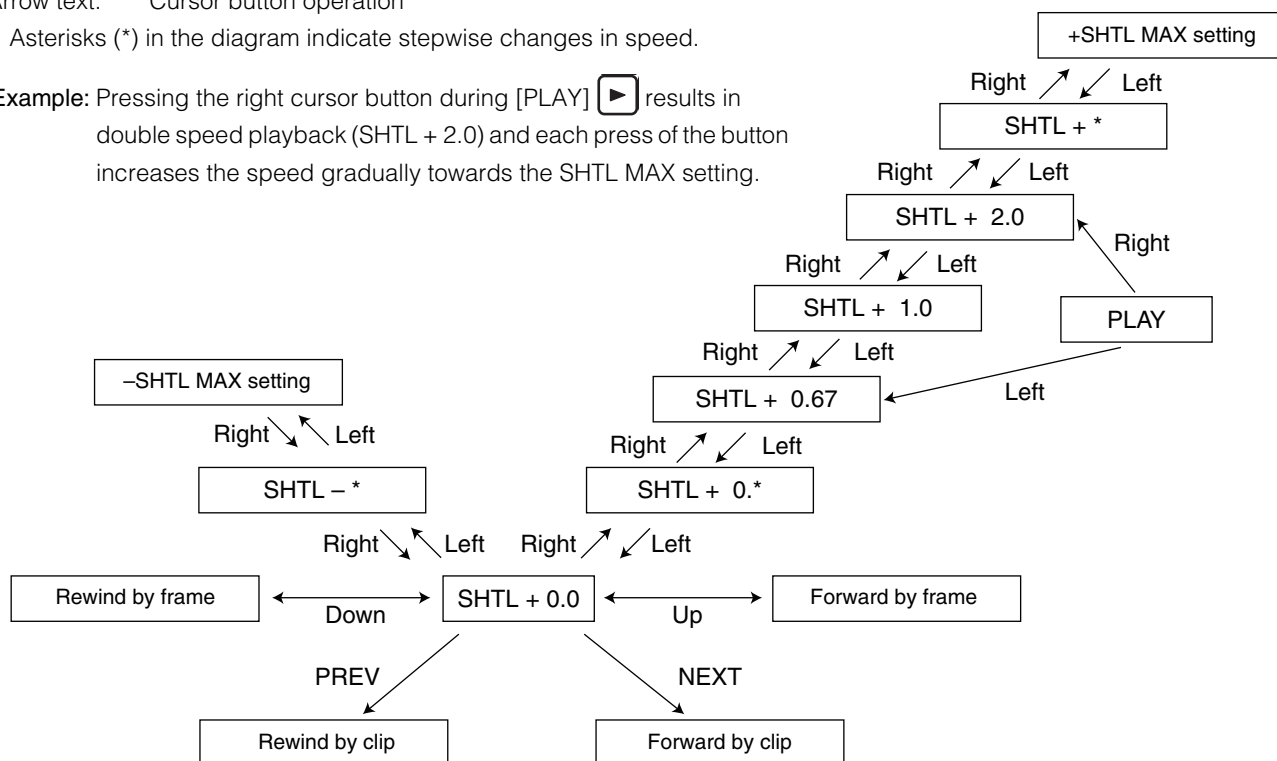

Repeat playback

Play back playable clips repeatedly.

1 Press [MENU] to display the menu.
(→ "Menu Operations" page 89)

2 Set the "REPEAT PLAY" (→ page 97) menu item to "ON."

3 Close the menu.

4 Press the [PLAY]  button to start playback.

All clips are played repeatedly.

- Repeat playback continues until the [STOP]  button is pressed.
- Repeat playback is not performed during playback other than normal playback, for example, variable playback, and playback stops at the beginning (BOS) or end (EOS) of a playable clip.
- During repeat playback, "REPEAT PLAY" is displayed for the operating status on the OSD.

Thumbnail Screen

This unit has a thumbnail screen for managing clips. A “clip” consists of a set of video, audio, and additional information such as metadata, and a “shot” is a clip generated by a single normal start-to-stop recording operation. A shot that spans multiple P2 cards is handled as one clip.

The thumbnail screen displays a list of thumbnails of recorded clips. You can perform the following clip management operations while checking these thumbnails.

- Playback of clips on P2 cards
- Simple playback of clips on a storage device
- Copying and deleting clips
- Adding text memos to clips
- Checking and deleting text memos
- Viewing and deleting shot marks
- Formatting P2 cards
- Viewing clip properties
- Viewing P2 card status

◆ Note:

- Thumbnails are generated from only a sample of the recorded video. Therefore, they appear coarser than the actual video.
- The menu items for thumbnails can be set when the thumbnail screen is displayed.

Displaying the Thumbnail Screen

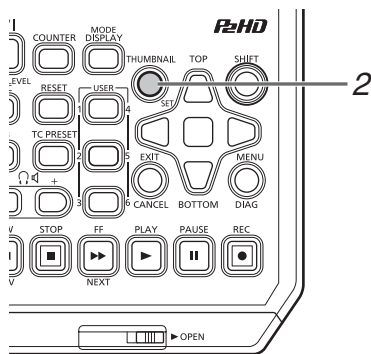

- 1 Press the [POWER] button on the unit for one second to turn the power on.

◆ Note:

If “THUMBNAIL” is selected in the “POWER ON GUI” (→ page 102) menu item, the thumbnail screen will appear at power-

on.

- 2 Press the [THUMBNAIL] button.

The thumbnail screen appears on the LCD monitor. Press the [THUMBNAIL] button again to close the thumbnail screen and return to the record/playback screen (video).

◆ Note:

The “GUI OUTPUT” (→ page 108) menu setting allows you to output to HDMI OUT and SDI OUT.

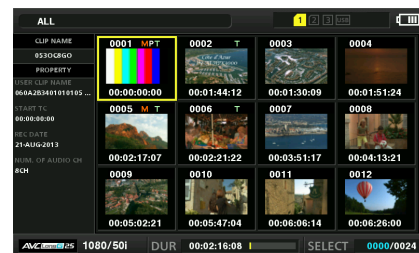

Names and Functions of the Parts of the Thumbnail Screen

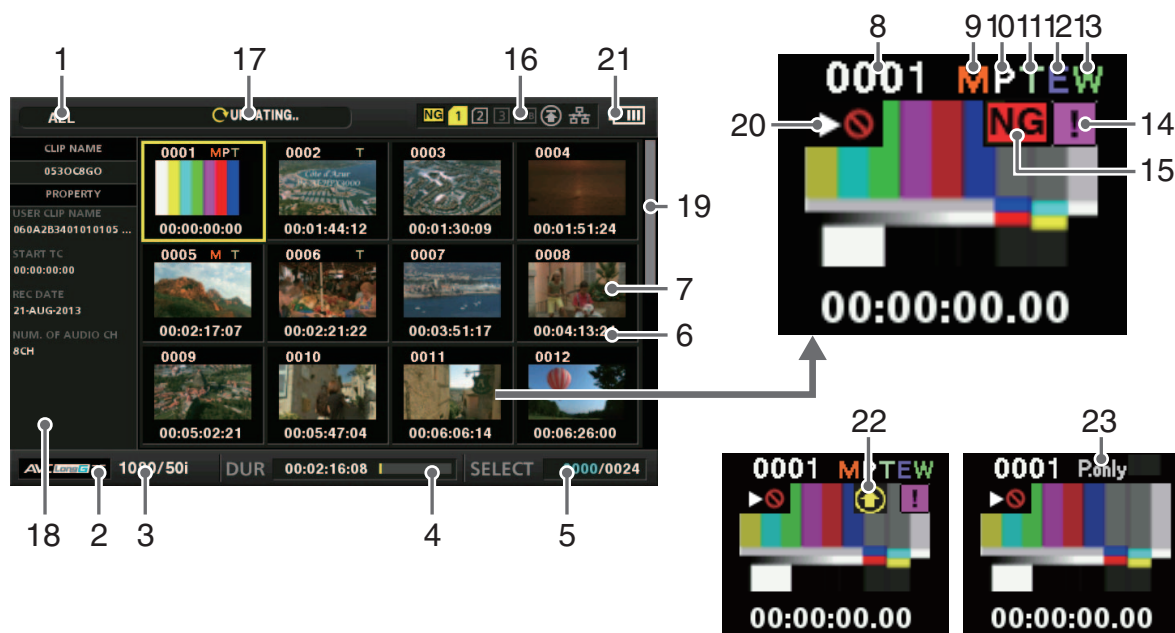

Main Mode

1. Display status

The following information is displayed on the screen.

| | |
|--------------|--|
| ALL: | All clips |
| SAME FORMAT: | Clips with the same format as the system |
| SELECT: | Clips selected with the [SET] button |
| MARKER: | Clips with shot markers added |
| TEXT MEMO: | Clips with text memo data added |
| SLOT n: | Clips on the P2 card in slot No. n |
| P2 / REMAIN: | Media information (amount of remaining free space) |
| P2 / USED: | Media information (amount of space used) |
| META DATA: | Set metadata |
| NG CLIP: | Bad clip |

Procedures for switching between displays
(→ “Changing the Thumbnail Display” page 44)

2. Recording mode

Indicates the recording mode of the clip at the cursor position.

3. System format

Indicates the recording format of the clip at the cursor position.

4. Duration

Indicates the length (duration) of the clip at the cursor position and the rough current playback position in relation to the length of the clip.

Playback position display is enabled when “RESUME” is selected in the “PB POSITION” (→ page 94) menu item. When the playback start position is not the beginning of the clip, the rough current playback position is indicated.

5. Number of selected clips, playback time display and bonding device information

When “THUMBNAIL INFO” on the “INFORMATION SEL.” (→ page 95) menu item is selected, the number of clips selected on the thumbnail screen and the playback times for each are displayed.

(→ “Setting the display of the number and durations of clips” page 44)

When “BONDING DEV. INFO” is selected, the signal strength and battery information for the bonding device is displayed.

6. Clip information display

One of the following is indicated: TC (time code), UB (user bits) at the start of clip recording, time of shooting, day of shooting, date and time of shooting, clip name, user clip name, and slot number.

(→ “Changing the Thumbnail Display” page 44)

7. Thumbnail

Shows the thumbnail recorded for each clip. You can use the EXCH.THUMBNAIL function to change this thumbnail. (→ “Changing the Thumbnail Display” page 44)

8. Clip number

Indicates the numbers assigned to P2 card clips, which are normally assigned in order from the earliest shooting date. For a clip that cannot be played back, the clip number is red and the unplayable indicator is displayed. You can change the order in which clips appear using the function for displaying clips in the order of selection or the SORT function.

(→ “Changing the Thumbnail Display” page 44)

9. Shot mark indicator

Indicates that a shot mark has been added to the clip.

10. Proxy indicator

Indicates that proxy data has been additionally recorded for the clip.

11. Text memo indicator

Indicates that text memo data has been added to the clip.

12. Edit copy indicator

Indicates an edit-copied clip.

13. Wide indicator

Indicates a clip recorded at an angle of view of 16:9. However, this is not indicated for an HD format clip.

14. Incomplete clip indicator



Indicates that the clip spans multiple P2 cards but one of the cards that contains part of the clip has not been inserted.

15. Bad clip and Unknown clip indicator

Indicates a clip that became defective because the power was turned off during recording or was damaged for some other reason. Clips with the yellow bad clip () indicator can sometimes be repaired.

(→ “Repairing bad clips” page 49)

Clips with the red clip indicator () cannot be repaired and should be deleted. If deleting is not possible, format the P2 card.

When a clip is not, for example, in the P2 standard format,  is displayed instead of .

◆ Note:

Proxy-only clips (i.e., clips that have been copied to a card in the SD card slot or clips copied using FTP (PROXY)) will be displayed as bad clips, as they do not contain AV data.

16. P2 card slot and storage device or NETWORK status indication

Indicates the P2 card and storage device or NETWORK connection status as shown below.



(Yellow)



This indicator is displayed when the inserted P2 card contains even one bad clip that may be repairable.

For details, refer to “15.  Bad clip and  Unknown clip indicator” (this page).



(Red)

This indicator is displayed when the inserted P2 card contains even one bad clip that is not repairable.

For details, refer to “15.  Bad clip and  Unknown clip indicator” (this page).

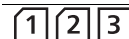

(White)

The numbers of P2 card slots that contain P2 cards are indicated in white.



(Yellow)

The number of the P2 card slot of the P2 card that contains the clip at the cursor position is indicated in yellow. When a clip spans multiple P2 cards, the numbers of all the slots with cards that contain the clip are indicated.

◆ Note:

For an inserted P2 card such as the following, the slot number has a red frame.

- “RUNDOWN CARD”

A P2 card for which the maximum number of overwrites has been exceeded.

- “DIR ENTRY NG CARD”

A P2 card with an unsupported directory structure.

- “AUTH NG CARD”

A microP2 memory card for which the CPS password cannot be authenticated.



(Gray)

Gray indicates that a storage device is not connected.



(White)

White indicates that a storage device is available.



(Yellow)

Yellow indicates that the clips on a storage device are displayed as thumbnails.



(Red)

Red indicates that a storage device is connected but is not available.















(Gray)

Gray indicates that the LAN setting is OFF.



(White)

White indicates that the LAN setting is ON.

| | |
|---|--|
|  | Yellow indicates that a LAN cable is connected and that there is a link. |
| (Yellow) | |
|  | Red indicates an error with the unit. Consult your dealer because the unit may have malfunctioned. |
| (Red) | |
|  | Gray indicates that the wireless LAN is not working properly. |
| (Gray) | |
|  | White indicates that the wireless LAN is in an unconnected state. |
| (White) | |
|  | Yellow indicates that the wireless LAN is in operation. |
| (Yellow) | |
|  | Red indicates that there is an error in the wireless LAN connection state. |
| (Red) | |
|  | Gray indicates that the 4G/LTE USB modem is not working properly. |
| (Gray) | |
|  | White indicates that the 4G/LTE USB modem is in an unconnected state. |
| (White) | |
|  | Yellow indicates that the 4G/LTE USB modem is in a connected state. The signal strength is indicated by yellow bars. |
| (Yellow) | |
|  | Red indicates that there is an error with the 4G/LTE USB modem connection. |
| (Red) | |
|  | Displayed in gray when upload has not started, or upload is complete. |
| (Gray) | |
|  | Displayed in yellow during upload. |
| (Yellow) | |
|  | Displayed from when upload error occurred until when the next transfer starts. |
| (Red) | |

17. Status message

Displays a message indicating the processing status. For example, the “UPDATING” text message and a rotating icon  are displayed during screen updating.

18. Simple property indication

Displays the properties of the clip at the cursor position. This is displayed when the “THUMBNAIL SIZE” (→ page 94) menu item is set to “SMALL.”

You can select the information to display from the menu. (→ “Setting the items to display as properties” page 44)

◆ Note:

When there are more characters than can be displayed, only the range of characters that can be displayed are shown.



19. Thumbnail scroll bar





Indicates the location of the currently displayed thumbnail among all of the thumbnails.



20. Unplayable indicator

Indicates a clip that cannot be played because, for example, the frequency differs from that of the system.

21. Battery level indicator





The  icon is displayed when the unit is powered by the battery, and the  is displayed when it is powered using the AC adaptor.

The indicator changes in the order of  →  →  →  →  as the battery level decreases.

When there is no battery power remaining,  () flashes.

22. Rec during upload status indicator

The rec during upload status indicator indicates the status of up to 100 clips registered in the upload list as follows.

| | |
|---|--|
|  | Displayed until uploading starts. |
| (Gray) | |
|  | Displayed during upload. |
| (Yellow) | |
|  | Displayed when uploading is completed normally and registered in the upload list. |
| (Green) | |
|  | Displayed when a transfer error occurred during uploading and registered in the upload list. |
| (Red) | |

23. [P.only] indicator

Indicates a clip with proxy only. (FTP explorer screen only)

Changing the Thumbnail Display

The thumbnail screen can be customized according to the operating conditions to improve efficiency.

Example:

- Set the settings of the “THUMBNAIL SETUP” (→ page 94) menu item as shown below.
Set “INDICATOR” to “ALL HIDE”
Set “DATA DISPLAY” to “CLIP NAME”
Set “THUMBNAIL SIZE” to “LARGE”
- Set the “REPOSITION” (→ page 92) menu item to “SELECTED CLIPS”.

Thumbnail screen display example



◆ Note:

The thumbnail output destinations can be switched in the “GUI OUTPUT” menu item (→ page 108).

Setting the thumbnails to display

- 1 Use the cursor buttons to align the cursor with the type of clips you want to display in the “REPOSITION” (→ page 92) menu item.
- 2 Press the [SET] button.

Setting the thumbnail size

- 1 Use the cursor buttons to align the cursor with the size of thumbnails you want to display in the “THUMBNAIL SIZE” (→ page 94) menu item.
- 2 Press the [SET] button.

Setting the display of clip information

The display of clip information can be customized according to purpose.

- 1 Use the cursor buttons to select the “DATA DISPLAY” (→ page 94) menu setting and then align the cursor with the item you want to set.
- 2 Press the [SET] button.

Setting the bonding device information display

- 1 Select “BONDING DEV. INFO.” below the “INFORMATION SEL.” (→ page 95) menu item using the cursor buttons.
- 2 Press the [SET] button.

◆ NOTE:

When information cannot be acquired from the bonding device, nothing will be displayed.

Setting the display of the number and durations of clips

- 1 Select “THUMBNAIL INFO.” below the “INFORMATION SEL.” (→ page 95) menu item using the cursor buttons.
- 2 Press the [SET] button.
- 3 Use the cursor buttons to align the cursor with the type of information you want to display in the “THUMBNAIL INFO.” (→ page 95) menu item.
- 4 Press the [SET] button.

Setting the items to display as properties

Set the simplified property display items to display on the left side of a thumbnail.

- 1 Use the cursor buttons to align the cursor with the “PROPERTY DISP.” (→ page 95) menu item.
- 2 Press the [SET] button to open the item menu.
All selected items are indicated by check marks.

3 Press the [SET] button to add a check mark for an item you want to display.

Pressing the [SET] button adds a check mark to an unchecked item and clears the check mark from a checked item.

Note:

- Up to six items can be displayed simultaneously.
- When the sixth item has been selected, no other unchecked item can be selected. Clearing the check mark from a checked item allows you to select another item.

Playing Back Clips

Playback

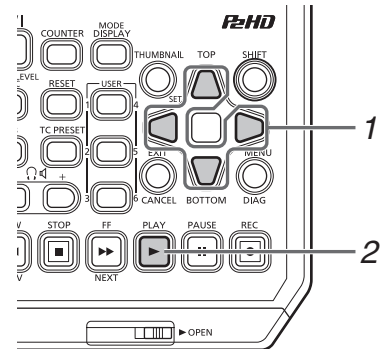

1 Use the cursor buttons to align the cursor with the clip you want to play.

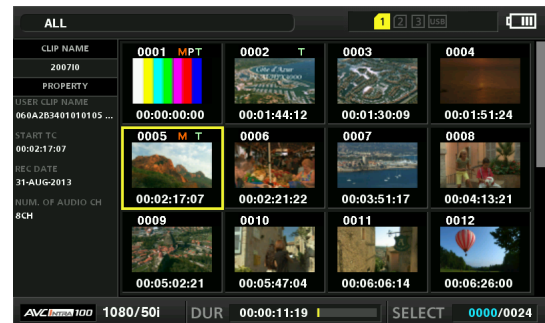

2 Press the [PLAY] button.

Playback begins from the clip at the cursor position. After the clip at the cursor position has been played, the subsequent clips are played back in order. When the last clip has been played, the thumbnail screen reappears.

Note:



- To play back a clip, you do not need to select it (so that the thumbnail appears inside a blue frame).
- You can change the thumbnail display settings to play back clips only from specified slots or play back only clips with text memos added.
- You can change the order that clips are played back.
 - 1 Select the clips in the order you want them to be played back.
 - 2 Select "SELECTED CLIPS" in the "REPOSITION" (→ page 92) menu item to switch the thumbnail display to only the selected clips (in the order they were selected).
- Pressing the [PAUSE] button instead of the [PLAY] button displays the first frame of the clip as a still image.
- A clip whose clip number is red cannot be played back.
- Pressing the [REW] button instead of the [PLAY] button rewinds playback, while pressing the [FF] button fast forwards playback.
- Pressing the [STOP] button during clip playback stops playback and redisplay the thumbnail screen.
- When playback is stopped, the cursor moves to the clip played prior to stopping.

- When clips in different compression formats are played back, the video and audio between clips may be distorted.
- When clips with the same video format but different audio bit rates are played back continuously, the audio between clips will be muted.
- Changing the thumbnail screen to text memo display allows you to start playback from a text memo position.
- You can select the playback start position for playback from thumbnails in the “PB POSITION” (→ page 94) menu item.

Playing back one clip (1 CLIP PLAY)

When “1 CLIP PLAY” is assigned to a [USER] button, pressing the [USER] button plays only the clip at the cursor position. (→ “USER BUTTON” page 110)

◆ Note:

- One clip playback is enabled only in thumbnail screen mode. The operation will become normal playback in recording/playback screen mode.
- When the thumbnail screen is redisplayed after one clip playback ends, the cursor moves to the next clip.
- All buttons except the [STOP]  button are disabled during one clip playback.
- One clip playback starts from the position set in the “PB POSITION” (→ page 94) menu item.
- When PAUSE/SHTL is used to display a still image during playback from the thumbnail screen, the [USER] button to which “1 CLIP PLAY” has been assigned allows you to play to the end of the clip from the position of the still image.
- One clip playback is also performed when the [PLAY]  button is pressed while holding down the [SHIFT] button.

Using variable speed playback and frame-by-frame playback

Operation is the same as in the recording/playback screen. (→ “Variable speed playback” page 37, “Frame-by-frame playback” page 38)

Playing back from a text memo position

- 1 Select “TEXT MEMO CLIPS” in the “REPOSITION” (→ page 92) menu item.

The thumbnails of clips with text memos are displayed at the top of the LCD monitor. Information on the clip text memo selected with the cursor is displayed at the bottom of the LCD monitor.



Thumbnail display Blue indicates selected number of text memo clips and white indicates total number of text memo clips. Indicates still images included with the text memos.

◆ Note:

- When a text memo clip with different settings for the “SYSTEM MODE” (→ page 114) menu item is displayed,  may be displayed instead of the thumbnail for the text memo position displayed at the bottom.

- 2 Select the clip with a text memo that you want play and press the [SET] button.

The cursor moves to the bottom of the LCD monitor.

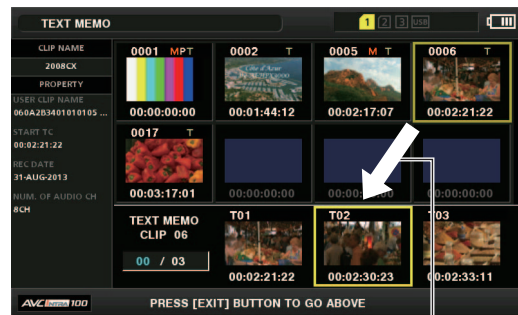

The cursor moves.

- 3 When the cursor is at the bottom, use the left or right cursor button to align the cursor with the thumbnail with a text memo that you want to play and then press the [PLAY]  button.

The clip is played back from the time code position of the text memo selected with the cursor. When you press the [STOP]  button to stop playback or when playback stops upon reaching the end of the clip, the thumbnail screen reappears and the cursor returns to the thumbnail of the text memo where playback was started. Press the [EXIT] button to return the cursor to the top of the thumbnail screen.

◆ Note:

All buttons except the [STOP]  button are disabled during playback.

Selecting and Deselecting Clips

Select the clips you want to process on the thumbnail screen.

Selecting clips

- 1 Use the cursor buttons to align the yellow frame (cursor) with the target clip.

◆ Note:

Press the [TOP] or [BOTTOM] button to move the cursor to the first or last clip.

- 2 Press the [SET] button.

A light blue frame and ✓ appear on the clip selected with the cursor to indicate that it is selected.



◆ Note:

- Repeat steps 1 and 2 to select multiple clips.
- Select a clip, move the cursor to another clip, and press the [SET] button while holding down the [SHIFT] button to select all of the clips from the clip selected first to the cursor position.
- Selecting a clip updates the number of selected clips indicated at the bottom right of the screen.

Deselecting clips

- 1 Align the cursor with a selected clip and press the [SET] button again.

The selection is canceled.

◆ Note:

Press the [CANCEL] button to deselect all of the selected clips.

Adding Text Memos and Shot Marks

A text memo can be added to a clip to mark a specific location of the clip. You can also add a shot mark to a clip to distinguish it from other clips. A text memo or shot mark cannot be added to a clip on a P2 card with the write-protect switch set to Protect.

Adding text memos

When a text memo is added, you can display a thumbnail at the text memo position for playback or copying and seek (move to) the text memo position by pressing the [NEXT] or [PREV] button during video playback.

(→ Setup Menu “SEEK POS SEL” page 98)

- 1 Assign “TEXT MEMO” to any [USER] button.

It is assigned to USER3 by default.

(→ Setup Menu “USER BUTTON” page 110)

- 2 Press the [USER] button to which “TEXT MEMO” has been assigned during recording, playback, or thumbnail display.

- Press this button during recording or playback to add a text memo at the position the button was pressed. The OSD displays “TEXT MEMO” (when successful) or “INVALID” (when adding was not possible).
- Pressing this button when the thumbnail screen is displayed adds a text memo at the position of the clip thumbnail (normally the beginning).

◆ Note:

- Up to 100 text memos can be added to one clip.
- Pressing the [USER] button to which “TEXT MEMO” has been assigned during playback may temporarily freeze the playback screen. This is normal and not a malfunction.
- Text memos cannot be recorded during loop recording.

Deleting text memos

Changing the thumbnail screen to the text memo display allows you to delete text memos.

- 1 Change the thumbnail screen to the text memo display.

Select “TEXT MEMO CLIPS” in the “REPOSITION” (→ page 92) menu item.

- 2 Use the cursor buttons to move to the thumbnail for which you want to delete the text memo and press the [SET] button.

The cursor moves to the bottom.

3 After pressing the [SET] button to select the thumbnail for which you want to delete the text memo, press the [SET] button in the “DELETE” (→ page 92) menu item.

When “DELETE” is assigned to a [USER] button, you can also perform the delete operation by pressing the [USER] button instead of making a menu selection.

4 Select “YES” in the confirmation message.

The text memo is deleted.

Adding shot marks

If you add a shot mark, you will be able to distinguish the clip from other clips because the mark will be displayed.

1 Assign “MARKER” to any [USER] button.

It is assigned to USER6 by default.

(→ Setup Menu “USER BUTTON” page 110)

2 Use the cursor buttons to align the cursor with the target clip.

3 Press the [USER] button to which “MARKER” has been assigned.

Each press of this button turns the shot mark indicator on/off.

◆Note:

- A shot mark is added to a clip even if the button is pressed in the recording/playback screen.
- When adding or deleting shot marks for a clip that spans multiple P2 cards, be sure to insert all of the P2 cards that the clip is recorded on.
- Shot marks cannot be added or deleted during loop recording.

Copying Clips

Clips can be copied to P2 cards, storage devices connected via USB, or FTP servers.

◆Note:

- Do not turn off the power or remove/insert a card during copying. Doing so may result in a bad clip.
- If a bad clip is created, delete it and perform copying again.
- Reconnect incomplete clips before copying.

1 Select a clip to copy.

2 Use the cursor buttons to align the cursor with a copy destination in the list of the “COPY” (→ page 93) menu setting and then press the [SET] button.

- When multiple clips are selected, the number of selected clips is indicated when you press the [SET] button.
- When the copy destination is a storage device (→ “Connecting an External Device via the USB HOST Port” page 57), select the details of the copy destination.
- When “COPY” is assigned to a [USER] button, you can also perform the copy operation by pressing the [USER] button instead of making a menu selection.
- When the copy destination is “SDCARD” or “FTP(PROXY)”, main line video and audio is not copied and only proxy data will be copied.

3 Align the cursor with “YES” in the confirmation message and press the [SET] button.

Copying of the clip begins.



◆Note:

- To stop copying, press the [SET] or [CANCEL] button to cancel the operation. Partially copied clips at the copy destination are deleted.
- When the same clip (clip with the same GLOBAL CLIP ID) exists in the copy destination because, for example, it has been copied previously, “OVERWRITE” appears. Select “YES” to overwrite or “NO” to cancel copying and press the [SET] button.

4 When the completion message appears, press the [SET] button.

◆Note:

- Copying is not performed when any of the following error messages appear.
 - “LACK OF CAPACITY”
Copying failed because there is insufficient space at the copy destination.
 - “UNKNOWN CONTENTS FORMAT!”
Copying failed because the selected clips include bad clips.
 - “NO COPY TO SAME CARD!”
Copying failed because an attempt was made to copy to the same card.
 - “TOO MANY CLIPS!”
Copying failed because too many clips were selected.
- When copying is performed while a text memo is selected in the text memo display at the bottom, the selected text memo position and the section to the next text memo is copied. When there is no text memo after the selected text memo, the section from the selected text memo to the end of the clip is copied.

Deleting Clips

Use the following procedure to delete unnecessary clips from a P2 card.

- 1 Select the clip to delete.
- 2 Use the cursor buttons to align the cursor with the “DELETE” (→ page 92) menu item and press the [SET] button.
- 3 Align the cursor with “YES” in the confirmation message and press the [SET] button.
All of the selected clips are deleted.

◆ Note:

- When “DELETE” is assigned to a [USER] button, you can also perform the delete operation by pressing the [USER] button instead of making a menu selection.
- To stop deletion, press the [SET] or [CANCEL] button to cancel the operation. Partially deleted clips cannot be restored by canceling.

Repairing and Reconnecting Clips

Repairing bad clips

The bad indicator (yellow **NG**) is displayed for any clip with a problem caused by, for example, a sudden power outage during recording. Use the following procedure to repair clips with problems.

- 1 Select the bad clip to repair.
- 2 Use the cursor buttons to align the cursor with the “REPAIR” (→ page 93) menu item and press the [SET] button.
- 3 Align the cursor with “YES” in the confirmation message and press the [SET] button.
Select “NO” to not repair the clip.

◆ Note:

Some clips are so badly damaged they cannot be repaired. Such clips are indicated by a red indicator (**NG**).

Reconnecting incomplete clips

A clip that is recorded on multiple P2 cards may become an incomplete clip (**I** indicator) due to not being recognized as a continuous clip. When this happens, you can use the reconnection function to reconnect the continuous clip segments to restore the original clip.

◆ Note:

- Incomplete clips occur under the following conditions.
 - When the segments of a continuous clip that are recorded on multiple P2 cards are copied separately for each P2 card.
 - When the segments of a continuous clip that are recorded on multiple cards are copied separately for each card to a storage device and then written back to the P2 cards.

- 1 Select the incomplete clips to reconnect.

◆ Note:

Normally, the thumbnails with the incomplete clip indicator (**I**) are grouped together.

- 2 Use the cursor buttons to align the cursor with the “RECONNECT” (→ page 93) menu item and press the [SET] button.

- 3 Align the cursor with “YES” in the confirmation message and press the [SET] button.

Select “NO” to not reconnect the clip segments.

◆ Note:

When some but not all the clip segments in a clip that consists of three or more clip segments are reconnected, the incomplete clip indicator (**I**) will remain displayed.

Viewing and Editing the Clip Information

Viewing the clip metadata information

The detailed information of a clip can be displayed and checked on a screen.

1 Use the cursor buttons to align the cursor with the target clip.

2 Use the cursor buttons to align the cursor with the "CLIP PROPERTY" (→ page 92) menu item and press the [SET] button.

The information on the selected clip appears.

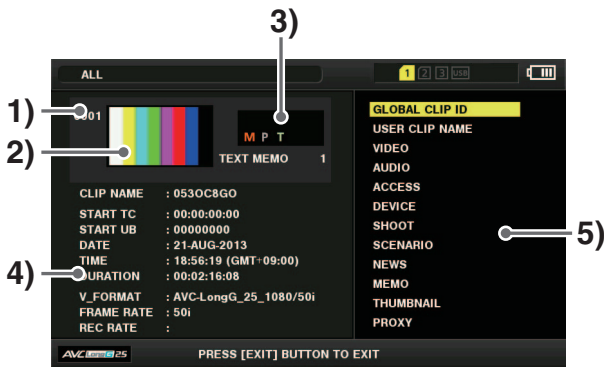

- 1) Clip number
- 2) Thumbnail
- 3) Information added to clips

Displays various indicators inserted in the clip and the number of text memos added to the clip. The mark is also displayed if the P2 card containing the clip is write protected.

4) Clip information

The following information is displayed.

| | |
|-------------|--------------------------------------|
| CLIP NAME: | Clip name |
| START TC: | Time code at start of recording |
| START UB: | User bit value at start of recording |
| DATE: | Date recorded |
| TIME: | Time at start of recording |
| DURATION: | Clip length |
| V_FORMAT: | Clip recording format |
| FRAME RATE: | Playback frame rate |
| REC RATE: | Recording frame rate |

5) Clip metadata

Displays the items for viewing detailed information (clip metadata) on the clip.

3 View the clip metadata if necessary.

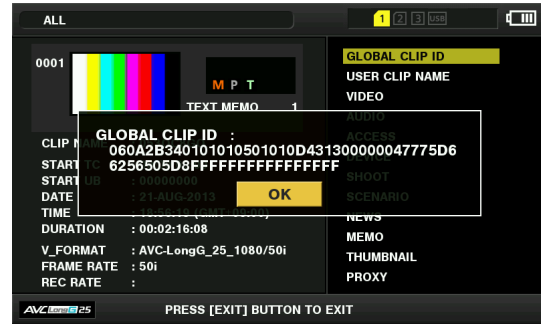

Use the cursor buttons to align the cursor with a metadata item and press the [SET] button to display the following information.

◆ Note:

The **bold items** are clip meta data that can be changed.

| | |
|-----------------|--|
| GLOBAL CLIP ID: | Global clip ID (This is a unique number, and there is no clip anywhere in the world with the same number.) |
| USER CLIP NAME: | The clip name the user assigns. This normally includes the GLOBAL CLIP ID. |
| VIDEO: | Video signal system (FRAME RATE, PULL DOWN, ASPECT RATIO) |
| AUDIO: | Audio channel system and other information (SAMPLING RATE, BIT RATE) |
| ACCESS: | The date of the last update and other information (CREATOR , CREATION DATE, LAST UPDATE DATE, LAST UPDATE PERSON) |
| DEVICE: | Manufacturer, serial number, and model name of the recording device. |
| SHOOT: | Date when recording started and ended, etc. (SHOOTER , START DATE, END DATE, ALTITUDE, LONGITUDE, LATITUDE, SOURCE, PLACE NAME) |
| SCENARIO: | Program name, scene number, and other information (PROGRAM NAME , SCENE NO., TAKE NO.) |
| NEWS: | Reporter, purpose, and object |
| MEMO: | Text memo number, OFFSET, PERSON, TEXT |

◆ Note:

- The position is indicated by the number of frames from the start.
- Up to 1000 characters of text can be added, but only the first 500 characters will be displayed.
- Use the left or right cursor button to move text numbers.

| | |
|------------|---|
| THUMBNAIL: | Frame position (normally, start: 0) of the image used for the thumbnail and the thumbnail size (width, height) |
| PROXY: | Detailed information on proxy data (Format, video codec, video frame rate, video bit rate, video resolution, aspect ratio, TC superimposition on video, audio codec, audio bit rate, sampling rate, and number of channels) |

Changing clip metadata

Clip metadata can be changed.

- 1 Display the clip metadata.
- 2 Use the cursor buttons to align the cursor with the metadata you want to edit and press the [SET] button.
The data that can be edited is indicated as "TEXT," like in the figure below.

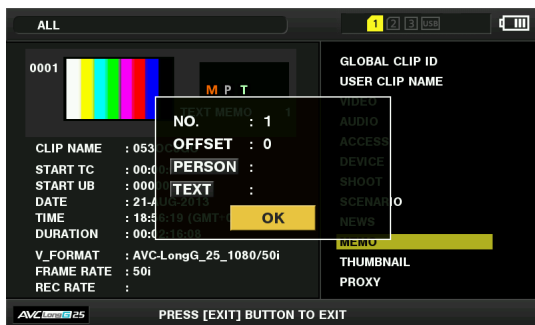

- 3 Use the cursor buttons to move to the item you want to change and press the [SET] button.
The screen for changing the metadata appears. (→ "Using a Keyboard" page 117)

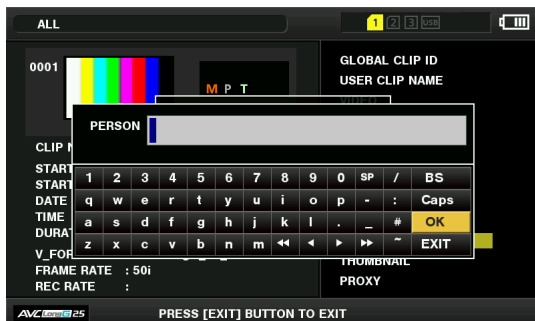

- 4 After you finish making changes, select "OK."
The changes made to the metadata are saved to the clip and the metadata display reappears. Select [EXIT] to cancel the changes and return to the previous display.

◆ Note:

- To delete the latitude and longitude, enter a blank space for the altitude. They cannot be deleted separately.
- The metadata of an incomplete clip with the **I** indicator cannot be changed. Insert the P2 card(s) containing the remainder of the clip.
- The MEMO item cannot be changed if a memo of 100 characters or more has been added.

- 5 Press the [EXIT] button to end the process.

Changing Thumbnails

A thumbnail can be changed to the image at a position with a text memo added.

- 1 Add a text memo to the video you want to change. (→ "Adding text memos" page 47)
- 2 Change the thumbnail display to the text memo display.
Select "TEXT MEMO CLIPS" in the "REPOSITION" (→ page 92) menu item.
- 3 Use the cursor buttons to move to the thumbnail to be changed and press the [SET] button.
The cursor moves to the bottom.
- 4 Use the left or right cursor button to move to the thumbnail you want to change.
- 5 Press the [MENU] button.
- 6 Use the cursor buttons to align the cursor with the "EXCH. THUMBNAIL" (→ page 93) menu item and press the [SET] button.
- 7 Align the cursor with "YES" in the confirmation message and press the [SET] button.
The menu closes and the thumbnail is changed.

◆ Note:

- You can view the change in the thumbnail position (number of frames from the beginning) in the "THUMBNAIL" item of the clip information display. The thumbnail of a normal first frame is indicated as 0.
- Even if a thumbnail is changed, playback from the thumbnail screen will be from the beginning of the clip.
- When a text memo clip with different settings for the "SYSTEM MODE" (→ page 114) menu item is displayed, **CLIP** may be displayed instead of the thumbnail for the text memo position displayed at the bottom.

Adding Metadata to Clips During Recording

A metadata upload file containing the shooter name, reporter name, shooting location, text memo, and other information can be saved to an SD memory card, and then recorded as clip metadata by loading it prior to recording.

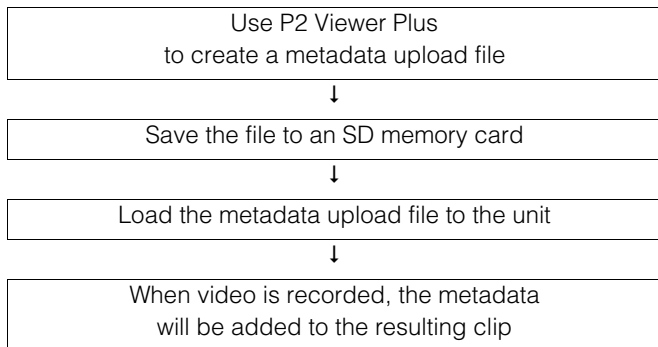

Preparing a metadata upload file

Use P2 Viewer Plus to create a metadata upload file on a computer.

P2 Viewer Plus is application software for using a personal computer to process clips recorded on a P2 card that can be downloaded free of charge from the Panasonic website. For the URL, refer to “Website URL” (→ page 9).

Install P2 Viewer Plus on a computer and then create a metadata upload file and write it to an SD memory card.

◆ Note:

- Use the latest version of the P2 Viewer Plus.
- For details on how to create a metadata upload file, refer to the help function in P2 Viewer Plus.
- Write the metadata upload file to an SD memory card formatted with the unit.
(→ “Formatting P2 Cards and SD Memory Cards” page 54)

Settings for adding metadata

■ Metadata recording setting

Set whether to add loaded metadata when recording clips in the “RECORD” (→ page 101) menu item.

■ Selecting the recording method of USER CLIP NAME

Set the type of data to record as “USER CLIP NAME” in the “USER CLIP NAME” (→ page 101) menu item.

The data recorded varies depending on the combination of the “USER CLIP NAME” and “RECORD” menu items.

| Recording method | USER CLIP NAME to be recorded |
|-----------------------------------|---|
| Clip metadata “RECORD” = “ON” | TYPE1: Loaded metadata settings |
| | TYPE2: Loaded metadata settings + counter value |
| Clip metadata “RECORD” = “OFF” | TYPE1: Same as GLOBAL CLIP ID |
| | TYPE2: Same as CLIP NAME |

■ Counter value

The counter value is indicated as a four-digit number. When the recording method of USER CLIP NAME is set to “TYPE2” and a metadata file is loaded, the counter value is incremented by 1 each time recording is performed to generate a new clip.

You can use the following procedure to reset the counter value.

1. Use the cursor buttons to align the cursor with “USER CLIP NAME” in the metadata screen of the “REC META DATA” - “PROPERTY” (→ page 101) menu item and press the [SET] button.
2. Use the cursor buttons to align the cursor with “COUNT RESET” and press the [SET] button.

The counter value is reset to 1.

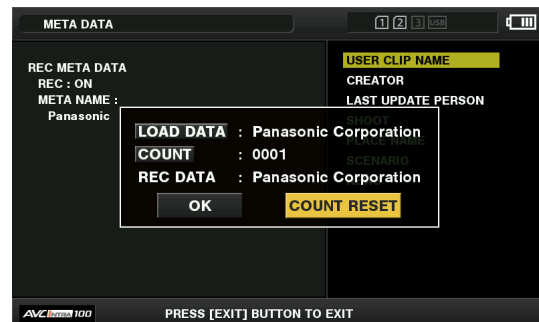

3. Press the [EXIT] button to end the process.

■ Adding the card serial number as metadata

Set the function for adding the serial number and other information of the P2 card as metadata (text memo without offset) in the “CARD SERIAL” (→ page 101) menu setting.

Metadata upload files

■ Loading a file

Use the following procedure to load the metadata settings from an SD memory card.

1. Insert the SD memory card containing the metadata upload file.
2. Display the thumbnail screen.
3. Press the [MENU] button.
4. Use the cursor buttons to align the cursor with the “REC META DATA” - “LOAD” (→ page 101) menu item and press the [SET] button.

The metadata name of the metadata upload file on the SD memory card appears.

◆ Note:

When the metadata name is displayed, press the right cursor button to display the file name.

Press the left cursor button to return to the metadata name.

5. Use the cursor buttons to align the cursor with the file to load and press the [SET] button.
 6. Align the cursor with “YES” in the confirmation message and press the [SET] button.
- The metadata is loaded.
7. Press the [MENU] button to end the process.

■ Checking and editing loaded metadata

The settings of the metadata loaded from an SD memory card can be checked.

1. Press the [MENU] button and select the “REC META DATA” - “PROPERTY” (→ page 101) menu item.
2. Use the cursor buttons to move the cursor and press the [SET] button.

Each setting of the loaded metadata can be checked.

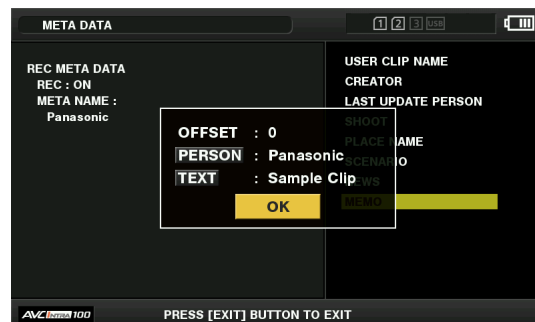

3. While viewing the metadata settings, use the cursor buttons to move the cursor to the item for which you want to change the setting and press the [SET] button.

When the software keyboard appears, change the setting.

◆ Note:

<Metadata types that can be set>

- Use the cursor button to align the cursor with the metadata item you want to check and press the [SET] button to display the information.

| | |
|---------------------|---|
| USER CLIP NAME: | Loaded user clip name, counter value, and recorded data |
| CREATOR: | Creator |
| LAST UPDATE PERSON: | Person who last updated the data |
| SHOOT: | Person who shot the clip |
| PLACE NAME: | Shooting location* ¹ |
| SCENARIO: | Program name, scene number, and take number |
| NEWS: | Reporter, purpose of data collection, and object of data collection |
| MEMO: | Name of the person who entered the memo and the text information |

- After checking the information, press the [EXIT] or [SET] button to close the screen displaying the information.
- When you finish changing the settings, select “OK.”

*¹: Location data from external devices can be set.

This unit can acquire location data (latitude, longitude and altitude) from bonding devices connected via network. Set the “GPS” (→ page 114) menu item to “EXTERNAL” to record the location data acquired to a clip as clip metadata.

Location data can be confirmed on the “STATUS DISPLAY” (→ page 108) menu item.

However, the location data may not be able to be acquired for some bonding devices that are connected.

Visit our website for more information to see the bonding devices from which location data can be acquired (→ “Website URL” page 9).
<https://pro-av.panasonic.net/>

4. Press the [EXIT] button to close the metadata confirmation screen.

■ Deleting the metadata settings

The metadata saved in the unit can be deleted to initialize the settings with the “REC META DATA” - “INITIALIZE” (→ page 101) menu item.

Formatting P2 Cards and SD Memory Cards

1 Use the cursor buttons to align the cursor with “SLOT n” (“n” is the number of the P2 card slot with the P2 card you want to format inserted) in the “FORMAT” (→ page 93) menu item and press the [SET] button.

◆Note:

- Selecting “SD CARD” will format the SD memory card inserted in the SD memory card slot.
- If a CPS password is set for the microP2 memory card, a confirmation message for selecting “CPS(ENCRYPT)” (encrypted format) or “NORMAL” (normal format) appears when you select the slot. If you select “CPS(ENCRYPT),” the microP2 memory card will be encrypted.

2 Select “YES” in the confirmation message and press the [SET] button.

Formatting begins.

◆Note:

- To cancel formatting, select “NO” and press the [SET] button.
- Be sure to check the data before formatting since data erased by formatting cannot be recovered.

3 When the confirmation message appears, select “OK” (press the [SET] button).

◆Note:

To format a P2 card or SD memory card in another P2 card slot, repeat steps 1 to 3.

Checking the Card Status

The P2 card slot status, P2 card usage status, and other card information can be displayed and checked on the screen.

1 Use the cursor buttons to align the cursor with the “CARD STATUS” (→ page 92) menu item and press the [SET] button.

The P2 card status appears.

◆Note:

You can switch the display between the remaining free space and used space in the “REMAIN SETUP” (→ page 92) menu item.

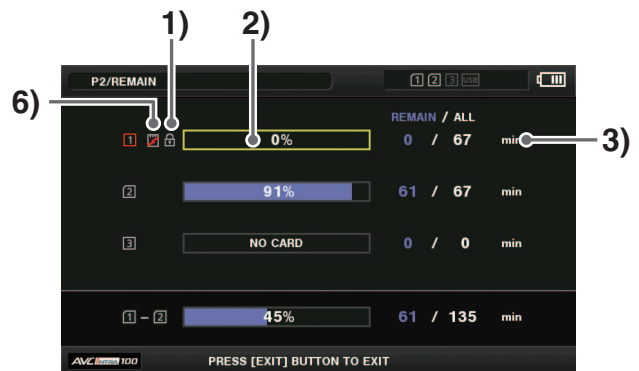

OR

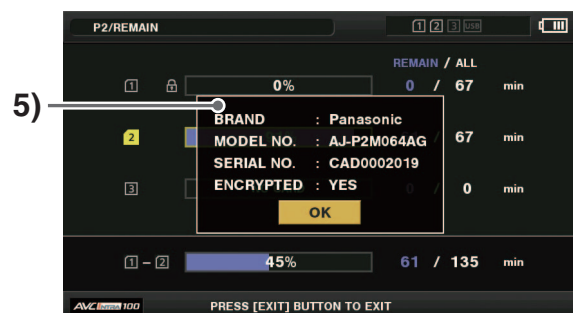
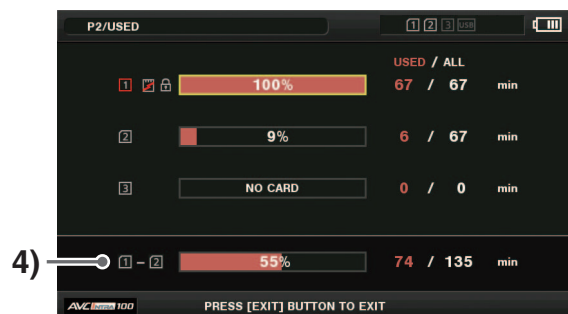

1) Write protected mark

The  mark is displayed when a P2 card is write protected.

2) P2 card status

When the remaining free space is displayed, the remaining free space on the P2 card is indicated in the form of a bar meter and as a percentage value. When the used space is displayed, the used space on the P2 card is indicated in the form of a bar meter and as a percentage value. The following may also be displayed depending on card status.

| | |
|-----------------|---|
| FORMAT ERROR!: | An unformatted P2 card is inserted. |
| NOT SUPPORTED!: | A card that is not supported by the unit is inserted. |
| NO CARD!: | No P2 card is inserted. |
| AUTH NG CARD: | A microP2 memory card for which the CPS password cannot be authenticated is inserted. |

3) Remaining free space (or used space) and total space on the P2 card

Indicates the remaining free space (or used space) and total space on the P2 card in minutes. Fractions of a minute are rounded off on the display so the sum total of the remaining free space (or used space) on each P2 card may not tally with the figure for the total space.

4) Total slot free space (or used space)

Indicates the value obtained by calculating the total of the remaining free space (or used space) on both P2 card slots.

◆ Note:

Free space of write protected P2 cards is not included in the free space total.

5) P2 card details display

Align the cursor with a slot in the P2 card status display and press the [SET] button to display the model number and other detailed information on the card. Press the [SET] button again or the [EXIT] button to close the detailed information screen.

◆ Note:

If the number of clips recorded on a P2 card exceeds the limit, "OVER MAX NUMBER CLIPS" is displayed in the P2 card details display to indicate that the limit has been exceeded.

6) Card warning mark

This warning is displayed for a P2 card in the following cases.

You can check the warning details in the P2 card details display.

- "RUN DOWN CARD"
The maximum number of overwrites for a P2 card has been exceeded.
- "DIR ENTRY NG"
The P2 card directory structure is not supported.
- "AUTH NG CARD"
A microP2 memory card for which the CPS password cannot be authenticated is inserted.

Manual and Automatic CPS Authentication

Manual CPS authentication

microP2 memory cards in an encrypted format are authenticated automatically by the unit, and can be used if authentication is successful.

If a microP2 memory card in a different encrypted format is inserted in a card slot of a device authenticated with a different CPS password, an authentication error occurs. To temporarily use the card for which the authentication error occurred, follow the procedure described in steps 1 and 2 to manually enter the authentication code (CPS password) for the microP2 memory card. If the code matches, you will be able to use that card.

1 Check the authentication failure.

Open the thumbnail screen and select the "CARD STATUS" (→ page 92) menu item to check the information. For a card with an authentication error, the slot number frame at the top right of the screen turns red and the remaining free space bar displays "AUTH NG CARD." Use the up or down cursor button to select that card.

2 Perform manual authentication.

Select the "AUTHENTICATE" (→ page 93) menu item in the card status screen to display the software keyboard for entering the CPS password.

Enter the password and select "OK."

When CPS password input is successful, the "AUTHENTICATED SUCCESSFULLY!" message appears. When CPS password input fails, a warning message (→ page 126) appears.

◆ Note:

- Manual authentication is only temporary. The manually set CPS password becomes invalid when the corresponding microP2 memory card is removed or the power is turned off.
- Up to 16 characters can be entered for the CPS password.
- For the conditions under which manual authentication is valid and other information, refer to the website. (→ "Website URL" page 9)

Automatic CPS authentication

A CPS password can be read from a SD memory card or input into the unit.

■ Setting the password

Loading the CPS password from an SD memory card

- 1 Download the latest version of P2 Viewer Plus to the personal computer and then install it.
- 2 Generate a CPS password with P2 Viewer Plus and then write it to an SD memory card.

◆Note:

- The generated CPS password file is encrypted, but take appropriate measures to avoid security risks. For example, format the SD memory card when the file is no longer needed.
- The generated CPS password is generated as a file with the “.p2p” extension in private/meigroup/pavcn/sbg/p2sd/ of the SD memory card. Do not delete this file until it has been loaded by the device.

3 Load the CPS password file.

- ① Turn on the power of the unit and then insert the SD memory card into the SD card slot.
 - ② Open the thumbnail screen.
 - ③ Select the “CPS PASSWORD” - “LOAD” (→ page 92) menu.
 - ④ Select the file to use from the displayed password file list and press the [SET] button.
- When loading of the CPS password is successful, the “LOADINGPASSWORD COMPLETED!” message appears.
 - When loading of the CPS password fails, a warning message appears. For details on the warning, refer to “Warning Details” (→ page 119).
 - If a warning message is displayed, check the insertion status of the SD memory card, the save location of the CPS password file (file name: *****.p2p) generated in step 2, etc.

Setting the CPS password with the software keyboard

- 1 Select the “CPS PASSWORD” - “SET” (→ page 92) menu item.

The software keyboard for entering the CPS password appears.

2 Enter the CPS password with the software keyboard

When you enter the password in “PASSWORD” and in “RETRY PASSWORD” for verification and then select “OK,” the CPS password is set.

- When CPS password input is successful, the “SETTING PASSWORD COMPLETED!” message appears.
- When CPS password input fails, a warning message appears. For details on the warning, refer to “Warning Details” (→ page 119).

◆Note:

- Up to 16 characters can be set for the password.
- Do not forget the password you entered because it cannot be displayed on a device.

■ Deleting the password

When you no longer need to use the CPS function, delete the CPS password.

To delete the CPS password, select the “CPS PASSWORD” - “DELETE” (→ page 92) menu item.

“DELETING PASSWORD COMPLETED!” appears and the CPS password is deleted.

◆Note:

When the setting becomes unset after deletion of the CPS password, automatic authentication of microP2 memory cards and the encrypted format function are disabled.

Connecting an External Device via the USB HOST Port

Supported storage devices

The following storage devices can be used.

- Hard disk drives or solid state drives connected via USB 2.0/USB 3.0.

Storage device types and available functions

The available functions depend on the type of storage device used. The storage device type is displayed below “PARTITION:” on the left side of the EXPLORE screen.

(→ “Viewing storage device information (EXPLORE screen)” page 60)

◆ Note:

- When using this unit with the battery, externally supply power to any storage device connected to the [USB3.0 HOST] port.
- The USB 3.0 connector supports USB bus power (5 V, 0.9 A), but startup may not be possible depending on the storage device. Should this happen, provide the storage device with a separate power supply.
- Storage devices over 2 TB (2018 GB) are not supported.

Storage device types and available functions

| Storage device type | Features | Available functions | | | | | | | | | |
|---------------------|---|---------------------|-------------------------------|----------------------------|-------------------------------|----------------------------|----------------------|----------------------|--------------------|--------------------|--------|
| | | Thumbnail Display | P2 card basis | | | | Clip basis | | Play-back check *3 | Clip image display | Format |
| | | | P2/microP2 (≤32 GB) → Storage | microP2 (>32 GB) → Storage | Storage → P2/microP2 (≤32 GB) | Storage → microP2 (>32 GB) | P2/microP2 → Storage | Storage → P2/microP2 | | | |
| TYPE S | A special format for high-speed writing/loading data on a card basis. | ✓ | ✓ | | ✓ | | ✓*1 | ✓ | ✓ | ✓ | ✓ |
| FAT | A storage device whose primary partition is formatted either in FAT16 or FAT32. The root partition or “CONTENTS” directory in any folder *2 is used. | ✓ | ✓ | | | | ✓ | ✓ | ✓ | ✓ | ✓ |
| OTHER | Storage device other than the above <ul style="list-style-type: none"> • A storage device with a file system other than FAT16 and FAT32, such as NTFS. | | | | | | | | | | ✓*4 |

*1 Adding clips to a partition will prevent writing back data on a card basis to that partition.

*2 There can be up to three levels of folders and the maximum number of folders is 100. The folders appear in order from the top level. Long file names and two-byte character file names are not supported.

Example:

| | |
|--------------------------------|---|
| /CONTENTS | Can be displayed |
| /SAMPLE/CONTENTS | Can be displayed |
| /SAMPLE/20090101/CONTENTS | Can be displayed |
| /SAMPLE/20090101/1200/CONTENTS | Cannot be displayed → This is the fourth level and will therefore not be displayed. |

*3 Audio and video dropouts may occur during playback from a storage device depending on its performance and operating conditions. Perfect playback cannot be guaranteed.

*4 2 TB or larger storage devices cannot be formatted.

◆ **Note:**

Use storage devices under the following conditions.

- Use storage devices within their operating specifications (temperature, etc.).
- Do not install storage devices in locations that are unstable or exposed to vibration.
- Some storage devices and cables may not operate normally.
- Use a storage device with sufficient space for copying.
- Do not connect a storage device together with other storage devices via a hub or other device, even if the other storage devices are not powered on. Do not connect other devices together with a storage device via a hub or other device.
- During formatting and copying, do not disconnect cables, do not remove a P2 card that is involved in any of these activities, and do not turn off this unit or the storage device. The unit and the storage device will need to be rebooted.
- A storage device is a high-precision instrument whose read and write functions may fail if used in an unsuitable environment. Please note that Panasonic Connect Co., Ltd. accepts no liability whatsoever for data loss or other damage, either direct or indirect, arising from a storage device failing or for some other reason.
- When the contents of a storage device used for copying from this unit are moved using a computer or other device, subsequent operation with the unit and the data of the storage device cannot be guaranteed.
- Panasonic Connect Co., Ltd. recommends repairing bad clips on P2 cards before copying them to a storage device.
- SATA (serial ATA) or PATA (parallel ATA) interface storage devices connected via a USB adaptor cable may not be recognized.
- Do not connect or disconnect cables during recording or playback with the unit. Recording or playback may not be performed normally.
- Depending on the storage device, the performance of the initial playback confirmation after a connection is established may be reduced.

Connecting a storage device

- 1 Connect the storage device to the [USB 3.0 HOST] port on the side.

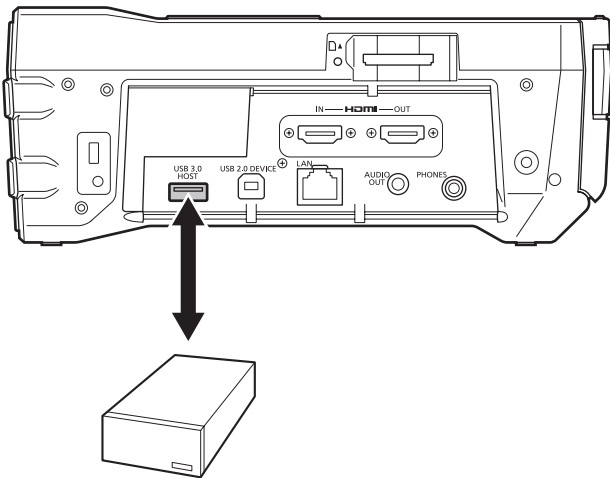

Portable storage device, etc.

- When connecting a USB 3.0 compatible storage device, use a cable that conforms to the USB 3.0 standard. With a USB 2.0 cable, the transfer rate of USB 2.0 will not be able to be exceeded.
- 2 When the storage device is recognized and becomes available for use, the (gray) icon at the top right of the thumbnail screen changes to (white).

Formatting a storage device

Format a storage device in the supported TYPE S or FAT format.

◆ **Note:**

Note that all data on the storage device will be deleted when it is formatted.

- 1 Connect the USB storage device.
When the storage device is recognized, the status indicator (→ page 42) for the storage device turns white (or red).
- 2 Use the cursor buttons to align the cursor with the “EXPLORE” (→ page 93) menu item, press the [SET] button, select “STORAGE,” and press the [SET] button. The EXPLORE screen opens.
- 3 Press the [MENU] button, use the cursor buttons to align the cursor with the “FORMAT (STORAGE)” (→ page 93) menu item, press the [SET] button, select the format (TYPE S or FAT), and then press the [SET] button.



4 Align the cursor with “YES” in the confirmation message and press the [SET] button.

5 When the confirmation message appears again, align the cursor with “YES” and press the [SET] button.

The storage device is formatted.

◆ **Note:**

Be sure to check the data before formatting since data erased by formatting cannot be recovered.

Exporting data to a storage device by card

Data can be exported to a storage device by card (writing data from a P2 card to the storage device). The copy result and maximum number of copies differ depending on the format of the storage device.

| Storage device type | Copy result | Maximum number of copies*2 |
|---------------------|---|----------------------------|
| TYPE S | A partition is created for each card, and all the data on a card is copied to the corresponding partition. The product number and serial number of the copied P2 card can be checked in the EXPLORE screen of the unit. | 23 |
| FAT | A folder*1 is created for each card, and all the data on a card is copied to the corresponding folder. The folder name can be checked on the EXPLORE screen of the unit. | 100 |

*1 Folders are created in two levels. A date (year/month/date) folder is created and then a time (hour/minute/second) folder is created inside the date folder.

Example: When 12:34:56 on March 30, 2014
/14-03-30/12-34-56

*2 Data that exceeds the size of the storage device cannot be copied.

1 Connect a storage device.

A storage device that is not in the TYPE S or FAT format will be formatted in the TYPE S or FAT format.
(→ “Formatting a storage device” page 58)

2 Insert a P2 card.

3 Use the cursor buttons to align the cursor with the “EXPORT” (→ page 93) menu item and press the [SET] button.

4 Align the cursor with the P2 card slot number that is the copy source and press the [SET] button.

When the storage device is in the TYPE S format, selecting “ALL SLOT” will result in a batch export of all inserted cards.

5 Align the cursor with “YES” in the confirmation message and press the [SET] button.

Exporting begins. A progress bar is displayed during exporting.

When exporting is completed, “COPY COMPLETED!” appears.

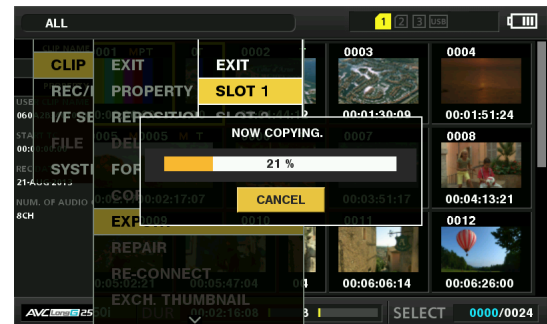

◆ **Note:**

- When the TYPE S format is used for exporting, the P2 card data and the copied data on the storage device can be verified (compared) automatically after exporting. In the factory default settings, verification is enabled for exporting. When verification is set not to be performed after exporting, the exported data is not verified so less time is required to complete the export operation.
To disable verification, set the “VERIFY” (→ page 96) menu item to “OFF.”
With the FAT format, verification is not performed regardless of this setting.
- To stop exporting, press the [SET] button, align the cursor with “YES” in the “CANCEL” confirmation message, and press the [SET] button.
- Stopping the process during verification has no effect because the copying of the P2 card has already finished.
- A microP2 memory card over 32 GB cannot be exported and imported. Copy the clips.

Copying clips to a storage device

You can copy just the selected clips rather than the entire card to a storage device.

- 1 Display the thumbnail screen, use the cursor buttons to align the cursor with a clip, and press the [SET] button.

You can also select multiple clips.

- 2 Use the cursor buttons to align the cursor with the “COPY” (→ page 93) - “STORAGE” menu item and press the [SET] button.

- 3 Select the copy destination in the storage device folder or partition list that appears and press the [SET] button.

◆Note:

- The following folders are displayed for a storage device in the FAT format.
 - Root folder
 - Up to three levels of folders containing the CONTENTS folder
- Copying is not possible on a TYPE S storage device without even one partition. Format the storage device in the FAT format or create a partition by exporting data, and then perform the copy operation.

- 4 Align the cursor with “YES” in the confirmation message and press the [SET] button.

Copying begins. A progress bar is displayed during copying. When copying is completed, the “COPY COMPLETED!” message appears.

◆Note:

- To stop copying, use the cursor buttons to align the cursor with “CANCEL,” press the [SET] button, align the cursor with “YES” in the “CANCEL” confirmation message, and press the [SET] button. Partially copied clips at the copy destination are deleted.
- When a clip is copied to a TYPE S storage device, it will not be possible to import data by card to that partition. In that case, “UNKNOWN” will be displayed for the card model number.

- 5 Press the [SET] button to complete the process.

Viewing storage device information (EXPLORE screen)

You can display storage device information, select the display of a storage device partition or folder thumbnails, and select a partition or folder as a target for operation (in the EXPLORE screen).

- 1 Use the cursor buttons to align the cursor with the “EXPLORE” (→ page 93) - “STORAGE” menu item and press the [SET] button.

The EXPLORE screen appears.

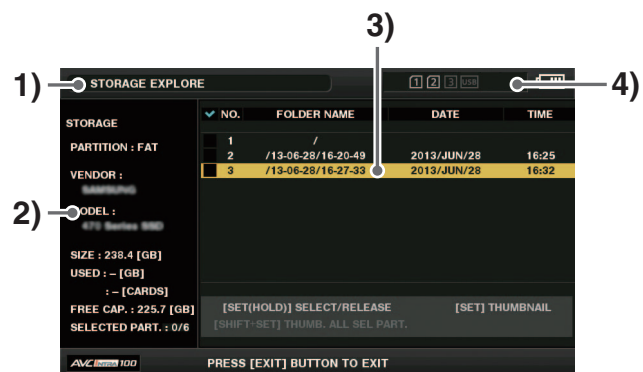

- 1) Display status

Indicates that the screen is the EXPLORE screen for a storage device.

- 2) Device information

The following information is displayed.

| | | |
|--|-----------------|---|
| Storage device that allows reading and writing by card (TYPE S). | PARTITION: | TYPE S |
| | VENDOR: | Vendor name |
| | MODEL: | Model name |
| | SIZE: | Total size (Unit: GB) |
| | USED: | Space used (Unit: GB) Used P2 card area (Unit: cards) Up to 23 cards |
| | FREE CAP.: | Remaining free space (Unit: GB) |
| | SELECTED PART.: | Number of selected partitions |
| Storage device other than the above (FAT or OTHER) | PARTITION: | FAT/OTHER |
| | VENDOR: | Vendor name |
| | MODEL: | Model name |
| | SIZE: | Total size (Unit: GB) |
| | FREE CAP.: | Remaining free space (Unit: GB) |
| | SELECTED PART.: | Number of selected folders |

3) Partition information

(for a TYPE S storage device)

| | |
|-------------------------------------|--|
| <input checked="" type="checkbox"/> | A check mark is displayed for a partition selected as an operation target. |
| NO.: | Partition number (1, 2, 3...) |
| MODEL: | P2 card model name |
| PARTITION NAME: | Name assigned to partition "Setting a partition name" (→ page 61) |
| DATE: | Partition recording date |
| TIME: | Partition recording time |
| SERIAL: | P2 card serial number |

Folder information

(for a FAT storage device)

| | |
|-------------------------------------|---|
| <input checked="" type="checkbox"/> | A check mark is displayed for a folder selected as an operation target. |
| NO.: | Folder number (1, 2, 3...) |
| FOLDER NAME: | Folder name (does not include the CONTENTS folder) |
| DATE: | Folder creation date |
| TIME: | Folder creation time |

◆ Note:

- Use the left or right cursor button to toggle between the partition names and serial name for a TYPE S storage device.
- The remaining free space of the corresponding partition can be checked in the "FREE CAP. OF PARTITION" (→ page 92) menu item.

4) Storage device indicator

Indicates whether a storage device is connected and the device type.

■ Operations in the EXPLORE screen

Selecting a partition or folder as a target for operation

Selecting a partition or folder as a target allows you to display all the clips in the selected partition or folder as thumbnails. (→ "Displaying the Thumbnail Screen" page 40)

Up to six partitions or folders can be selected as targets for operation.

1. Align the cursor with a partition or folder in the EXPLORE screen.

2. Hold down the [SET] button (for at least 1 second).

The partition or folder is selected and becomes .

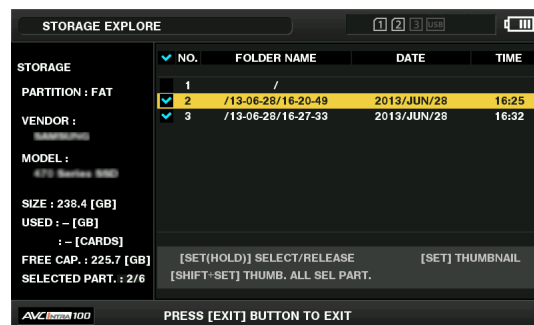

The selected operation targets remain available until the storage device is disconnected or the power is turned off. To cancel an operation target selection, select it and hold down the [SET] button again (for at least 1 second). Pressing the [CANCEL] button cancels all selections.

- When an attempt is made to select a 7th item, the item is not set and a warning appears.

◆ Note:

- A clip recording that spans a partition whose MODEL has become "UNKNOWN"*1 and another partition on a TYPE S storage device will not become one normal clip.
*1 When a clip is copied to a TYPE S storage device, MODEL of the copy destination partition changes to "UNKNOWN."
- Partition names can be set for a TYPE S storage device. A set partition name is displayed in "PARTITION NAME" in the EXPLORE screen.

Setting a partition name

In the case of a TYPE S storage device, a name (up to 20 characters) can be assigned to a partition.

◆ Note:

A set partition name is displayed in "PARTITION NAME" in the EXPLORE screen.

1. Align the cursor with the partition you want to set in the EXPLORE screen for the storage device.

You can also press the [SET] button to display the thumbnail list and then enter a partition name.

2. Press the [MENU] button.

3. Use the cursor buttons to align the cursor with the "CHANGE PARTITION NAME" (→ page 94) menu item and press the [SET] button.

The software keyboard appears.

4. Enter the name to set for the partition and select "OK."

The partition name is set.

Deleting the last partition

The last partition of a storage device can be deleted in the "DELETE LAST PARTITION" (→ page 94) menu item.

◆ Note:

- Move the cursor to the last partition beforehand.
- Deletion of the last partition is only possible for a TYPE S storage device. Only the last partition can be deleted. A partition before the last partition cannot be deleted.
- Carefully check the partition before executing this because a deleted partition cannot be recovered.

■ Viewing thumbnails of clips on a storage device and viewing video on the monitor

Displaying thumbnails

The thumbnail screen can also be displayed to manage clips stored on a storage device in the same way as for a P2 card inserted in the unit.

1. Display the EXPLORE screen.

A list of partitions or folders appears.

2. Use the cursor buttons to align the cursor with the partition or folder for which you want to display the thumbnail screen and press the [SET] button.

The clips in that partition or folder are displayed as thumbnails. Press the [EXIT] button to return to the EXPLORE screen.

◆ Note:

When operation targets are selected, pressing the [SHIFT] + [SET] buttons displays the thumbnails for all the partitions selected as operation targets.

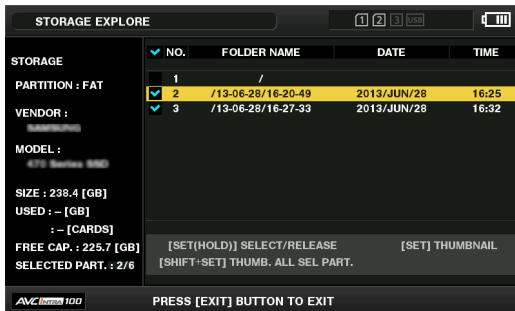

SET ▼ ▲ EXIT



1) Clip information

Displays the clip properties.

2) Storage device information

When TYPE S

| | |
|---------------------|---|
| SERIAL: | P2 card serial number |
| MODEL: | P2 card model name |
| SELECTED PART.: | Displays a check mark (☑) when the partition is selected as an operation target. |
| SELECTED PART. No.: | This is displayed only when multiple partitions are selected, and shows a list of the numbers of the selected partitions. |
| NO.: | Partition number (1, 2, 3...) |
| DATE: | Partition recording date |
| TIME: | Partition recording time |
| VERIFY: | Verification setting for recording and verification result |
| ON: | Verification was successful |
| FINISHED | |
| ON: | Verification failed |
| FAILED | |
| OFF: | Verification was not performed |
| NAME: | User assigned partition name |
| SIZE: | Total size of storage device |
| USED: | Used space of storage device |
| FREE CAP.: | Remaining free space of storage device |

When FAT

| | |
|---------------------|---|
| SELECTED PART.: | Displays a check mark (☑) when the partition is selected as an operation target. |
| SELECTED PART. No.: | This is displayed only when multiple folders are selected, and shows a list of the numbers of the selected folders. |
| NO.: | Folder number (1, 2, 3...) |
| DATE: | Folder creation date* ¹ |
| TIME: | Folder creation time* ¹ |
| FOLDER: | Folder name |
| SIZE: | Total size of storage device |
| FREE CAP.: | Remaining free space of storage device |

*¹The creation date and time are not displayed for root.

◆ Note:

- You can change the thumbnail screen display if necessary. The operation is the same as when displaying thumbnails for a P2 card (→ "Changing the Thumbnail Display" page 44).
- There is a limit of 1000 clips and clips that exceed this limit will not be displayed.

Viewing clip information

Various metadata information can be viewed for the clips stored on a storage device. The information can be displayed in the same way as for P2 card clip properties.

1. Move the cursor to the target clip in the thumbnail screen of the storage device.
2. Press the [MENU] button.
3. Use the cursor buttons to align the cursor with the “CLIP PROPERTY” (→ page 92) menu item and press the [SET] button.
(→ “Viewing and Editing the Clip Information” page 50)
Editing is not possible.

Deleting clips

You can delete the clips on a storage device that are no longer needed.

1. Select a clip to delete in the thumbnail screen of the storage device.
2. Press the [MENU] button.
3. Use the cursor buttons to align the cursor with the “DELETE” (→ page 92) menu item and press the [SET] button.
4. Align the cursor with “YES” in the confirmation message and press the [SET] button.

◆ Note:





Clips indicated by **NG** (bad clip indicator) and **?** (unknown clip indicator) may not be able to be deleted.



Checking the video and audio of a clip

1. Display the thumbnail screen of the storage device.
2. Use the cursor buttons to align the cursor with the clip you want to view.
3. Press the [PLAY]  button.

Playback begins from the clip at the cursor position. When the clip at the cursor position ends, subsequent clips are played back in order. When the last clip has been played, the thumbnail screen of the storage device is redisplayed.

◆ Note:

- To play back a clip, you do not need to select it (so that the thumbnail appears inside a blue frame).
- You can change the thumbnail display settings to play back only selected clips or play back only clips with text memos added.
- Pressing the [SEARCH] button instead of the [PLAY]  button displays the first frame of the clip as a still image.
- Pressing the [REW]  button instead of the [PLAY]  button rewinds playback, while pressing the [FF]  button fast forwards playback.
- A clip whose clip number is red cannot be played back.

- Pressing the [STOP]  button during clip playback stops playback and redisplay the thumbnail screen.
- When playback is stopped, the cursor moves to the clip played prior to stopping.
- When clips in different compression formats are played back, the video and audio between clips may be distorted.
- Text memos, metadata, and other data cannot be added or edited.
- When “1 CLIP PLAY” is assigned to a [USER] button, pressing that [USER] button allows you to play back only the clip at the cursor position.
- Audio and video may stop or dropouts may occur during playback depending on the storage device. Use a high-speed storage device to prevent dropouts. A warning appears when video dropouts occur. Press the [STOP]  button or other button to close the warning message.

Writing back (importing) data from a storage device to a P2 card

■ Importing data from a TYPE S storage device by partition

You can import data (on a P2 card basis) to a P2 card with the same model number as the source card (write back data from a storage device to a P2 card) by partition.

1. Insert the import destination P2 card.
Be sure to insert a formatted P2 card.
2. Connect a storage device.
3. Select "STORAGE" in the "EXPLORE" (→ page 93) menu item to display the EXPLORE screen.
4. Display the thumbnails of the partition to be imported in the EXPLORE screen.
5. Select the "IMPORT" (→ page 93) menu item.
6. Align the cursor with the P2 card slot number that is the import destination and press the [SET] button.
Select "YES" in the confirmation message to begin importing.
When importing is completed, the "COPY COMPLETED!" message appears.

◆Note:

- When data is imported to a P2 card that differs from the original P2 card, some clips may become incomplete (display the incomplete indicator). Should this happen, use the reconnection function to rebuild the clips.
(→ "Reconnecting incomplete clips" page 49)
- You can select whether to perform verification at the time of copying in the "VERIFY" (→ page 96) menu item.
- It is not possible to import data by partition to P2 cards with different model numbers. Copy the data on a clip basis.

■ Copying to a P2 card by clip

You can specify a clip on a storage device and copy it to a P2 card.

1. Display the thumbnail screen of the storage device.
2. Select a clip to copy.
3. Press the [MENU] button.
4. Align the cursor with the copy destination in the list of the "COPY" (→ page 93) menu item and press the [SET] button.

Select "YES" in the confirmation message to begin copying.

When copying is completed, the "COPY COMPLETED!" message appears.

Using the Unit Connected to a Network

Network Connection

This unit can connect to a network via wireless LAN, wired LAN, or 4G/LTE. Connecting a bonding device to the wireless LAN or wired LAN will allow for high-speed network connectivity.

To use wireless LAN, connect an AJ-WM30/AJ-WM50 (sold separately) to the [USB3.0 HOST] port.

To use wired LAN, connect a LAN cable to the [LAN] port on the side.

To use 4G/LTE, connect a compatible USB modem (sold separately) to the [USB3.0 HOST] port.

For the 4G/LTE USB modems that can be connected, visit the Support Desk on our website (→ “Website URL” page 9).

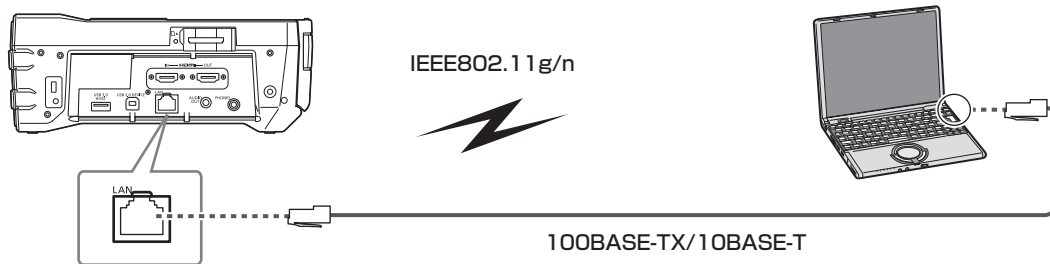

Available Functions

The following functions are available when the unit is connected to a network.

- Checking thumbnail images
- Proxy playback
- Downloading proxy files and clip management information
- Displaying and editing metadata
- Adding and deleting metadata (shot marks and text memos)
- Simple editing of clip playlist using proxy
- Sending and receiving clips with the unit (transferring clips using the FTP client function)
- Streaming function

Operating Environment

The following operating environment is required to connect to a network.

- Windows
Microsoft Windows® 8.1 Professional 32/64-bit, Internet Explorer 11 (Classic View)
- Mac
Mac OS X v10.9.x (Mavericks) *1, Safari 7
*1 Operation is guaranteed only for a pre-installed or clean-installed system.
- iPad/iPhone
iOS v7.x

For the latest information, visit the website.

■ Web browser

A Web browser is required to perform web control.

- For the latest information on compatible browsers, see the website. (→ “Website URL” page 9)

■ Media player

QuickTime is required to play proxy video.

- For the latest information on the versions for which operation has been verified, see the website. (→ “Website URL” page 9)

Preparing for Connection

For the wireless module AJ-WM30/AJ-WM50

Connect the AJ-WM30/AJ-WM50 wireless module (sold separately) to the [USB 3.0 HOST] port on the unit.

■ Notes regarding use of wireless module

For the latest information, visit the website. (→ “Website URL” page 9)

◆ Note:

In France, outdoor use is prohibited.

For wireless module other than AJ-WM30/AJ-WM50

Connect the 4G/LTE USB modem (sold separately) or other wireless module to the [USB3.0 HOST] port on the unit.

◆ Note:

- For the USB 2.0 extension cable (sold separately), we recommend using a cable that is no longer than 0.5 m (19-5/8 inches) between the Type A male and female connectors and is double shielded to reduce noise.
- For the 4G/LTE USB modems and other wireless modules that can be connected, visit Support Desk on the website. (→ “Website URL” page 9)

For wired LAN

Connect the cable.

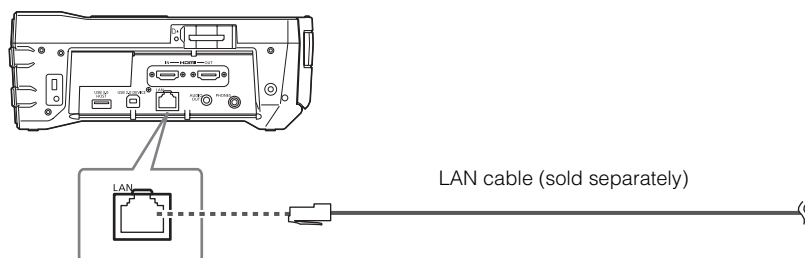

- 1 Connect the LAN cable to the [LAN] port at the rear.

Network Settings

Various settings need to be set to connect via a wireless LAN or wired LAN. Set the settings for the function you will use.

Wireless LAN Settings

These settings are for connecting to a mobile device (iPad/iPhone), computer, or wireless access point via a wireless LAN.

■ DIRECT Mode

These settings are for directly accessing the network functions of the unit from a smartphone, tablet, or computer.

- 1 Select "WLAN" in the "NETWORK SEL" (→ page 105) menu setting.

When you change these settings, restart the unit if necessary.

- 2 Select "DIRECT" in the "WIRELESS PROPERTY" - "TYPE" (→ page 106) menu setting.

- 3 Configure each item in the "WIRELESS PROPERTY" (→ page 106) menu setting as necessary.

MAC ADDRESS:

MAC address of the wireless LAN (This cannot be changed.)

SSID:

Network name (SSID) of unit (Factory default setting: AJ-PG50)

BAND:

Setting that switches between 2 transmission methods (2.4 GHz or 5 GHz) (Factory setting: "2.4GHz") (When using the AJ-WM30, set this to "2.4GHz." When using the AJ-WM50, set this to "2.4GHz" or "5GHz.")

CHANNEL (2.4GHz):

Channel used when set to 2.4 GHz (Factory setting: "AUTO")

CHANNEL (5GHz):

Channel used when set to 5 GHz (Factory setting: "AUTO")

ENCRYPTION:

Encryption method to use (Factory default setting: WPA2-AES)

ENCRYPT KEY:

WPA2 encryption key (Factory default setting: 01234567890123456789abcdef)

DHCP:

Set whether to use automatic assignment by DHCP (**ENABLE**: Use automatic assignment / **DISABLE**: Do not use automatic assignment) (Factory default setting: **ENABLE**) (This cannot be set.)

IP ADDRESS:

IP address of unit (Factory default setting: 192.168.0.1)

SUBNET MASK:

Subnet mask (Factory default setting: 255.255.255.0)

DEFAULT GATEWAY:

Default gateway (Factory default setting: 192.168.0.254) (This cannot be set.)

PRIMARY DNS:

Primary DNS server setting (Factory default setting: 0.0.0.0) (This cannot be set.)

SECONDARY DNS:

Alternate DNS server setting (Factory default setting: 0.0.0.0) (This cannot be set.)

DHCP SERVER:

Set whether to use the DHCP SERVER function (**ENABLE**: Use the DHCP SERVER function / **DISABLE**: Do not use the DHCP SERVER function) (Factory default setting: **ENABLE**)

- 4 Select the SSID from the mobile device and computer access point list and then enter the password (encryption key).

Display the access point list screen from the wireless settings and then select the SSID of this unit.

- Factory default setting: AJ-PG50

When the password confirmation screen appears, enter the password (encryption key).

- Factory default setting: 01234567890123456789abcdef

- 5 Check the network connection.

When the settings are complete, check whether the network connection of the mobile device (iPad/iPhone) or computer is correct.

If the network connection is correctly established, you can use the application for using the network (P2 Browser).

However, the FTP client function cannot be used when the unit is connected with "DIRECT." (→ "P2 Browser Function" page 72)

◆ Note:

- The AJ-WM30 can only operate with 2.4 GHz as the communication method. When [BAND] is set to [5GHz], it will automatically be changed to AUTO of 2.4 GHz before operation.
- The startup time after turning on the power may be longer due to starting of the network.
- When you change the "NETWORK SEL" settings, the changes will not be reflected until the unit is restarted. When the setting is changed, it may take a while for the settings screen to close because the network service is restarted.
- The combination of the IP address, subnet mask, and default gateway must be correct. If the "CANNOT ACCESS GATEWAY!" warning appears as the setup screen closes, consult the network administrator.
- IP addresses from [192.168.255.0] to [192.168.255.255] cannot be used because they are reserved by the system.
- When a default gateway or DNS will not be used, set the settings to "0.0.0.0."
- DHCP and DNS may not function properly depending on the network environment.

■ INFRA Mode

These settings are for connecting with a wireless access point.

1 Select "WLAN" in the "NETWORK SEL" (→ page 105) menu setting.

When you change these settings, restart the unit if necessary.

2 Select "INFRA" in the "WIRELESS PROPERTY" - "TYPE" (→ page 106) menu setting.

3 Configure each item in the "WIRELESS PROPERTY" (→ page 106) menu setting as necessary.

Set "SSID," "ENCRYPTION," and "ENCRYPT KEY" in accordance with the wireless access point to which the unit will connect.

MAC ADDRESS:

MAC address of the wireless LAN (This cannot be changed.)

BAND:

Setting that switches between 2 transmission methods (2.4 GHz or 5 GHz) (Factory setting: "2.4GHz") (Cannot be set)

CHANNEL (2.4GHz):

Channel used when set to 2.4 GHz (Factory setting: "AUTO") (Cannot be set)

CHANNEL (5GHz):

Channel used when set to 5 GHz (Factory setting: "AUTO") (Cannot be set)

SSID INPUT MODE:

Select "MANUAL" to set this manually and select "SELECT" to select from the connection destination list.

CHANNEL:

Channel to use (Factory default setting: AUTO) (This cannot be set.)

ENCRYPTION:

Encryption method to use (Factory default setting: WPA2-AES)

DHCP:

Set whether to use automatic assignment by DHCP (ENABLE: Use automatic assignment / DISABLE: Do not use automatic assignment) (Factory default setting: ENABLE)

IP ADDRESS:

IP address of unit (Factory default setting: 192.168.0.1)

SUBNET MASK:

Subnet mask (Factory default setting: 255.255.255.0)

DEFAULT GATEWAY:

Default gateway (Factory default setting: 192.168.0.254)

PRIMARY DNS:

Primary DNS server setting (Factory default: 0.0.0.0) (If DHCP is set to "ENABLE" and assignment from the DNS server is possible, the value will be overwritten by the externally assigned DNS server value. The value is unset when it is "0.0.0.0.")

SECONDARY DNS:

Alternate DNS server setting (Factory default: 0.0.0.0) (If "DHCP" is set to "ENABLE" and assignment from the DNS server is possible, the value will be overwritten by the externally assigned DNS server value. The value is unset when it is "0.0.0.0.")

DHCP SERVER:

Set whether to use the DHCP SERVER function (ENABLE: Use the "DHCP" SERVER function / DISABLE: Do not use the DHCP SERVER function) (Factory default setting: ENABLE) (This cannot be set.)

4 Enter the SSID and password (encryption key) of the connection destination wireless point.

(When setting manually)

1) Select "MANUAL" in "SSID INPUT MODE."

2) Set the SSID of the connection destination wireless access point to the SSID of this unit.

- Factory default setting: AJ-PG50

3) Set the password of the connection destination wireless access point to the password set in "ENCRYPT KEY" of this unit.

- Factory default setting:

01234567890123456789abcdef

(When acquiring from list)

1) Select "SELECT" in "SSID INPUT MODE."

2) Use the cursor buttons to select a SSID and press the [SET] button.

- The SSID connection destination list screen (→ page 69) appears.
- If you select an SSID and then press the [SET] button while pressing the [SHIFT] button, the selected SSID is deleted from the connection history.
- If you select [DELETE ALL HISTORY] and then press the [SET] button, all SSID are deleted from the connection history.

3) Set the password of the connection destination wireless access point to the password set in "ENCRYPT KEY" of this unit.

5 Check the network connection.

When the settings are complete, check whether the network connection between this unit and the wireless access point is correct.

If the network connection is correctly established, the network status icon at the top right of the thumbnail screen turns yellow and you can use the applications for using the network (P2 Browser (→ page 72) and FTP Client functions (→ page 74)).

◆ **Note:**

- The startup time after turning on the power may be longer due to starting of the network.
- When you change the “NETWORK SEL” settings, the changes will not be reflected until the unit is restarted. When the setting is changed, it may take a while for the settings screen to close because the network service is restarted.
- The combination of the IP address, subnet mask, and default gateway must be correct.
If the “CANNOT ACCESS GATEWAY!” warning appears as the setup screen closes, consult the network administrator.
- IP addresses from [192.168.255.0] to [192.168.255.255] cannot be used because they are reserved by the system.
- When a default gateway or DNS will not be used, set the settings to “0.0.0.0.”
- DHCP and DNS may not function properly depending on the network environment.
- Up to 20 connections are saved in the connection history. When 20 is exceeded, the connections are deleted in order from the oldest.
- The status of the SSID connection destination list is current at the time the list was displayed and is not refreshed automatically.

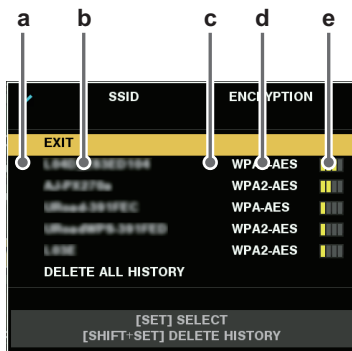
SSID Connection Destination List

a: Selection state

b: SSID

c: Presence/absence of connection history

d: Encryption method

e: Signal strength

- Display is in order from the strongest signal.
- The SSID with the check mark for the selection state is the selected SSID.
- The H indication for the presence/absence of connection history indicates an SSID for which connection history is stored. Even if a connection destination is out of range, the SSID is displayed on the last row of the list.

Use the up or down cursor to select an SSID and press the [SET] button.

4G/LTE Mode

These settings are for connecting with a 4G/LTE USB modem.

1 Select “4G/LTE” in the “NETWORK SEL” (→ page 105) menu setting.

When you change these settings, restart the unit if necessary.

2 When the menu “4G/LTE PROPERTY” (→ page 107) is enabled, select “4G/LTE PROPERTY”, and set the items as necessary.

When the setting of “4G/LTE PROPERTY” is required for the connected 4G/LTE USB modem, “4G/LTE PROPERTY” will become enabled.

When following setting is required, enter the information provided from the provider accurately.

APN:

Sets the APN (Access Point Name) provided by the provider.

USER ID:

Sets the user name provided by the provider.

PASSWORD:

Sets the password provided by the provider.

DIAL NO.:

Sets the phone number. For details, refer to instructions provided by the provider to which you are subscribed.

3 Check the network connection.

Check whether the connection between the unit and the 4G/LTE network has been established.

If the network connection is correctly established, the network status icon at the top right of the thumbnail screen turns yellow and you can use the application for using the network (FTP Client Function). (→ “Using FTP Client Functions” page 74)

◆ **Note:**

- The startup time after turning on the power may be longer due to starting of the network.
- When you change the “NETWORK SEL” settings, the changes will not be reflected until the unit is restarted. When the setting is changed, it may take a while for the settings screen to close because the network service is restarted.

Wired LAN Settings

These settings are for connecting to a computer via a wired LAN.

1 Select "LAN" in the "NETWORK SEL" (→ page 105) menu setting.

When you change these settings, restart the unit if necessary.

2 Configure each item in the "LAN PROPERTY" (→ page 106) menu setting as necessary.

DHCP and DHCP SERVER are exclusive settings.

MAC ADDRESS:

MAC address of the wired LAN (This cannot be changed.)

DHCP:

Set whether to use automatic assignment by DHCP (**ENABLE**: Use automatic assignment / **DISABLE**: Do not use automatic assignment) (Factory default setting: ENABLE)

IP ADDRESS:

IP address (Factory default setting: 192.168.0.1)

SUBNET MASK:

Subnet mask (Factory default setting: 255.255.255.0)

DEFAULT GATEWAY:

Default gateway (Factory default setting: 192.168.0.254)

PRIMARY DNS:

Primary DNS server setting (Factory default setting: 0.0.0.0)

SECONDARY DNS:

Alternate DNS server setting (Factory default setting: 0.0.0.0)

DHCP SERVER:

Set whether to use the DHCP SERVER function (**ENABLE**: Use the DHCP SERVER function / **DISABLE**: Do not use the DHCP SERVER function) (Factory default setting: DISABLE)

3 Set the wired LAN of the computer.

(For Windows)

Display [Properties] of [Internet Protocol Version 4(TCP/IPv4)] and configure the settings. For details on the display procedure, refer to [Start] → [Help and Support]

- When "DHCP SERVER" is set to "ENABLE" in the unit settings
Select [Obtain an IP address automatically] and [Obtain DNS server address automatically] on the [General] tab.
Select [Automatic private IP address] on the [Alternate Configuration] tab.
- When "DHCP SERVER" is set to "DISABLE" in the unit settings
Select [Use the following IP address] on the [General] tab, and configure the following items.
 - [IP address]
 - [Subnet mask]
 - [Default gateway], [Preferred DNS server] and [Alternate DNS server]: There is no need to enter any specific value.

(For Mac OS)

- When "DHCP SERVER" is set to "ENABLE" in the unit settings
[Configure IPv4]: Select [Using DHCP].
[Configure IPv6]: Select [Automatically].
- When "DHCP SERVER" is set to "DISABLE" in the unit settings
[Configure IPv4]: Select [Manually] and enter the values for following items.
 - [IP Address]
 - [Subnet Mask]
 - There is no need to set [Router] so leave it blank.
[Configure IPv6]: Select [Automatically].

Client settings

To transfer clips with the FTP function, you need to set the connection destination and other settings in advance. Set the settings in the “FTP CLIENT SERVICE” (→ page 105) menu item.

CLIENT SERVICE:

| Item | Description | Setting value | Factory default setting |
|-----------------------------|--|---|-------------------------|
| SETTING DATA | Sets from where client service settings are acquired. | INTERNAL: Uses the settings set on the unit. SD CARD: Uses the settings of the file inside the SD memory card inserted in the SD card slot. When this item is set to “SD CARD”, insert an SD memory card before turning on the power of the unit. | INTERNAL |
| SERVER URL | Name or address of connection destination server | Enter with the full keyboard. (Up to 500 characters) | Unset |
| LOGIN USER / LOGIN PASSWORD | User ID and password for connecting | Enter with the full keyboard. (Up to 31 characters for the user ID and up to 15 characters for the password) | Unset |
| SSH | Set this to use SSH for file transfers. | ENABLE: Enables SSH. DISABLE: Disables SSH. | DISABLE |
| SSH PORT | Set the network port number when using SSH. Set this to the same number as on the server side. | Enter with the numeric keyboard. | 22 |

- The set password cannot be displayed on the unit.

◆ Note:

- When “WLAN” is set in the “NETWORK SEL” menu item and “DIRECT” is set in the “TYPE” menu item, the FTP client function will not operate.

Saving the settings of the client service to the SD memory card

- Select “SAVE (SD CARD)” in the “FTP CLIENT SERVICE” menu item.
The settings of the “SERVER URL,” “LOGIN USER,” “LOGIN PASSWORD,” “SSH,” and “SSH PORT” menu items are saved to the SD memory card.

Loading the settings of the client service from the SD memory card

- Select “LOAD (SD CARD)” in the “FTP CLIENT SERVICE” menu item.
The settings of the client service are loaded from the SD memory card and then reflected in the settings of the unit.

P2 Browser Function

■ Starting the application (P2 Browser) from the Web browser

When the network connection with the mobile device or computer is established, start the browser on the mobile device or computer and then start the application (P2 Browser).



Fig. 1

- 1 Select "BROWSE" or "BROWSE(+CTRL)" in the "HTTP SERVER" (→ page 105) menu setting.
The P2 Browser function is enabled.
- 2 Start the browser (Safari or Internet Explorer) on the mobile device or computer.
- 3 Enter the IP address set for the unit in the address bar of the browser.
 - Factory default setting: 192.168.0.1
- 4 Press the Enter key in the case of a computer and tap the GO button in the case of an iPad or iPhone.
The Web application (P2 Browser) starts.
- 5 Enter the user name and password in the input screen.

Enter the value set for "USER ACCOUNT" (factory default setting: guest) and the value set for "PASSWORD" (factory default setting: p2guest) on the unit.

The connection is established when the screen in Fig. 1 appears.

You can set a user account name and password in the "USER ACCOUNT" (→ page 105) menu setting.

You can register a new account, delete an account, or change a password in the "ACCOUNT LIST" (→ page 105) menu setting.

The user account name can be up to 31 characters long and the password can be from 6 to 15 characters long. For information on P2 Browser, refer to Operating Instructions of P2 Web Application available from the following website.

<https://pro-av.panasonic.net/manual/en/index.html>

◆ Note:

- When "NETWORK SEL" is "WLAN," "4G/LTE," or "LAN," the startup time when the power is turned on may be longer than usual due to the network function starting.
- When "NETWORK SEL" is set to "OFF," the network function will not be available.
- When the "NETWORK SEL" setting is changed, the change is not applied until the unit is restarted. When the setting is changed, it may take a while for the settings screen to close because the network service is restarted.
- The combination of the IP address, subnet mask, and default gateway must be correct.
If the "CANNOT ACCESS GATEWAY!" warning appears as the setup screen closes, contact your network administrator.
- When a default gateway and DNS will not be used, set the settings to "0.0.0.0."
- DHCP and DNS may not operate properly in some network environments.

P2 Playlist Editing Functions

The following functions are supported.

- Editing/saving playlists
- Creating new clips from playlists (edit copy)
- SDI playback using playlists
- Displaying and editing metadata
- Adding and deleting metadata (shot marks and text memos)

For how to change modes and other information, refer to "P2 Playlist Editing Mode" (→ page 83).

Operation check tools, status indication, and initialization

You can check the network connection status of an FTP client.

■ Checking the connection (PING)

- 1 Display the thumbnail screen.
- 2 Press the [MENU] button to display the menu.
(→ “Menu Operations” page 89)
- 3 Use the up or down cursor button to align the cursor with the “PING” (→ page 108) menu item and press the [SET] button.
- 4 Check the connection status for the set address.
When a connection is confirmed, “PING SUCCESSFUL!” appears.
“PING FAILED!” appears if a connection cannot be established within approximately 30 seconds. Use the log described in the next section to determine the cause of the failure.

■ Viewing the connection log (LOG)

- 1 Press the [MENU] button to display the menu.
(→ “Menu Operations” page 89)
- 2 Use the up or down cursor button to align the cursor with the “LOG DISPLAY” (→ page 108) menu item and press the [SET] button.
Check the information in the log.
- 3 After you finish checking, press the [EXIT] button to return to the menu.

◆ Note:

- Some operations may not generate any information in the log.
- The password is indicated as “*” in the log.

■ Status display

- 1 Press the [MENU] button to display the menu.
(→ “Menu Operations” page 89)
- 2 Use the cursor buttons to align the cursor with the “STATUS DISPLAY” (→ page 108) menu item and press the [SET] button.
The connection status appears.
- 3 After you finish checking, press the [EXIT] button to return to the menu.

◆ Note:

- The status information is not updated in real-time. To view the most recent information, perform the steps above again.
- When “DHCP” is set to “ENABLE,” the values may differ from those of ordinary LAN settings.
- When “DHCP” is enabled, the status information is not displayed correctly while the address information is being obtained.
- The default gateway is not displayed as status information if it is not set correctly.
- If only SECONDARY DNS is set and PRIMARY DNS is not set in the LAN settings, the DNS is indicated as “DNS1.”

■ Initializing the network settings (INITIALIZE)

- 1 Press the [MENU] button to display the menu.
(→ “Menu Operations” page 89)
- 2 Use the cursor buttons to align the cursor with “NETWORK TOOLS” - “INITIALIZE” (→ page 108) and press the [SET] button.
The menu reappears when initialization is completed.

Using FTP Client Functions

To use the FTP client functions, you need to set the NETWORK settings and FTP client settings in advance.

FTP server folder list (FTP EXPLORE screen)

Locate the FTP server folder tree to display a list of subfolders in folders and folder information. You can also display a list of the thumbnails in any CONTENTS folder (folder containing the P2 card clips).

- 1) Display the thumbnail screen.
- 2) Press the [MENU] button to display the menu. (→ “Menu Operations” page 89)
- 3) Use the cursor buttons to align the cursor with the “EXPLORE” (→ page 93) - “LAN” menu item and press the [SET] button.

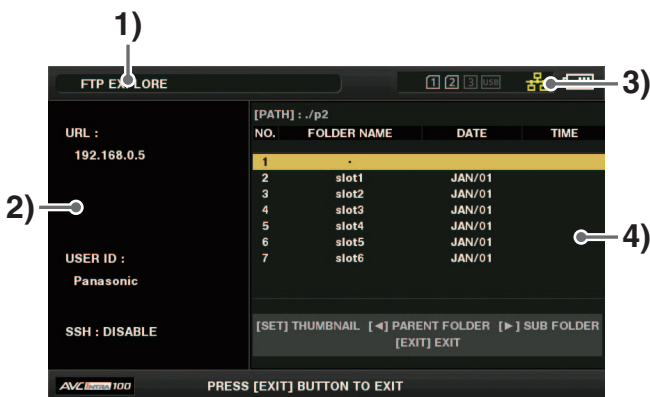

1) Display status

Indicates that the screen is the FTP EXPLORE screen.

2) FTP server information

The following information is displayed.

| | |
|----------|--|
| URL: | URL of connected FTP server |
| USER ID: | User ID of logged in user |
| SSH: | Indicates whether SSH is set to ENABLE or DISABLE. |

3) Media status

Indicates the P2 card insertion status, hard disk connection status, type, and LAN cable connection status. The LAN indicator displays the following status.

| | |
|---------|--|
| Gray: | Gray indicates that the LAN setting is OFF. |
| White: | White indicates that the LAN setting is ON. |
| Yellow: | Yellow indicates that a LAN cable is connected and that there is a link. |
| Red: | Red indicates an error with the unit. Consult your dealer because the unit may have malfunctioned. |

◆Note:

There is a delay of a few seconds between the updating of the LAN indicator and the actual status.

4) Folder information

| | |
|--------------|--------------------------------------|
| PATH: | Path of current folder on FTP server |
| NO.: | Folder number (1, 2, 3...) |
| FOLDER NAME: | Folder name |
| DATE: | Date of last update |
| TIME: | Time of last update |

◆Note:

- The folder list displays only folders, and does not display ordinary files or link files.
- “.” indicates the current folder. No date and time information is displayed.
- The date and time information is either the local time or world standard time, but depends on the information from the FTP server. Sometimes only the year or time is displayed.
- Whether text is case sensitive or not depends on the FTP server.
- Folder names using multi-byte characters are not displayed correctly.
- Up to 100 folders can be displayed in a folder. The 101st folder and subsequent folders cannot be accessed from the FTP EXPLORE screen. However, if a folder name is directly added to [FTP CLIENT URL:] in the FTP client settings, the contents of that folder can be accessed even if it is the 101st folder or a subsequent folder.
- Connectivity and folder display may differ from that of a computer connected to an FTP server.
- Depending on the FTP server and the connection environment, error messages may not be displayed correctly.
- To stop an operation when connected, press the [SET] button.
- If an error occurs, perform the operation again.
- An error may be generated when a network operation is performed right after connecting a LAN cable or stopping the previous operation.
- Check the connection with PING when performing an operation several times results in a connection error. If PING fails, check whether the LAN settings are correct and the LAN cable, wireless module, or 4G/LTE USB modem is connected properly and whether any hubs or routers in the path are operating normally. If PING is successful, check whether the server function services of the FTP server are running, whether there is a firewall in the communication path, and whether a user ID and password that permits access to the FTP server have been set. Note that it may be possible to connect using FTP even when PING fails.
- If a connection cannot be established even after performing the above checks, consult with the system administrator of your network environment.
- Some GUI operations may not be possible for a while after an FTP server operation has been cancelled.

Operations in the FTP EXPLORE screen

| | |
|-----------------------------|---|
| Right cursor button: | Indicates the contents of the subfolder at the cursor position. |
| Left cursor button: | Indicates the contents of the folder at the level above the current folder. |
| Up and down cursor buttons: | Moves the cursor. |
| [TOP] and [BOTTOM] buttons: | Moves the cursor to the top or bottom level folder in the list. |

◆ Note:

- Server operating specifications and access privileges may prevent the display of folder contents, the correct folder path, etc.
- The unit remembers the previous cursor position in a folder. However, an error will reset it to the top level. Also, if thumbnails are displayed, the unit only remembers the cursor position in the folder list displayed immediately before.

Viewing the Thumbnails of Clips on an FTP Server (FTP Thumbnail Screen)

Thumbnails on an FTP server can also be displayed in the same way as for a P2 card inserted in the unit.

FTP thumbnail display

- 1** Display the FTP EXPLORE screen.
A list of folders appears.
- 2** Use the cursor buttons to align the cursor with the folder in the CONTENTS folder whose thumbnails you want to display and press the [SET] button.
The clips in that folder are displayed as thumbnails.

◆ Note:

- Pressing the [SET] button in the CONTENTS folder will not display thumbnails. Be sure to press the [SET] button in folders above the CONTENTS folder or in the current folder indicated by [.]
- When there is both an uppercase "CONTENTS" folder and lowercase "contents" folder, the contents of the uppercase folder are displayed.
- When there is a mixture of folders with uppercase names and folders with lowercase names below the CONTENTS folder, correct access may not be possible or error messages may be inappropriately displayed.

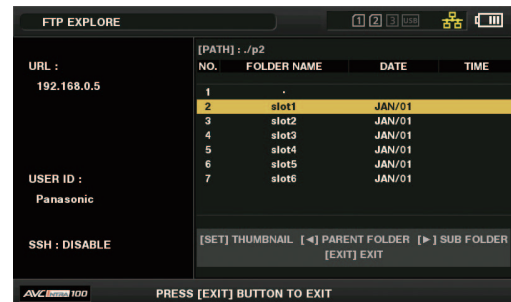

SET EXIT



1) Clip information

Indicates the properties of the clip at the cursor position.
(→ "Thumbnail Screen" page 40)

2) FTP server/folder information

| | |
|----------|---|
| URL: | URL of connected FTP server |
| USER ID: | User ID of logged in user |
| SSH: | Indicates whether SSH is set to ENABLE or DIS- ABLE |
| PATH: | Path of the currently displayed thumbnail folder on the FTP server |
| DATE: | Date of last update |
| TIME: | Time of last update |

◆ Note:

- Press the [EXIT] button to return to the EXPLORE screen.
- There is a limit of 1000 clips and clips that exceed this limit will not be displayed.
- The date and time information is either the local time or world standard time, but depends on the information from the FTP server.
- If "." is selected and thumbnails are displayed, the folder date and time information will not be displayed.

Deleting Clips on the FTP Server

The clips on an FTP server that are no longer needed can be deleted in the same way as for a P2 card.
(→ "Deleting Clips" page 49)

◆ Note:

The FTP server may disconnect the connection if you leave the FTP thumbnails displayed without performing an operation, and it will not be possible to delete clips after that. Should this happen, return to the FTP EXPLORE screen, display the FTP thumbnails again, and then delete the clips.

Viewing FTP Server Clip Information

Various metadata information can be viewed for the clips on an FTP server.

The information and the procedure to display the information are the same as for P2 card clip properties.

1 Move the cursor to the target clip in the FTP thumbnail screen.

The detailed information of a clip can be displayed and checked on a screen.

2 Press the [MENU] button to display the menu.

(→ "Menu Operations" page 89)

3 Use the cursor buttons to align the cursor with the "CLIP PROPERTY" (→ page 92) menu item and press the [SET] button.

◆ Note:

- Metadata can be viewed but not edited.
- The FTP server may disconnect the connection if you leave the FTP thumbnails and FTP properties displayed without performing an operation, and it will not be possible to perform operations such as displaying thumbnails after that. Should this happen, return to the FTP EXPLORE screen, display the FTP thumbnails again, and then perform the operation.

Transferring Clips

Clips on a P2 card or hard disk can be transferred to an FTP server, and written back from the FTP server to the P2 card or hard disk.

Transferring to an FTP Server (Copy)

1 Display the thumbnail screen and select the clip to transfer.

2 Press the [MENU] button to display the menu.

(→ "Menu Operations" page 89)

3 Use the cursor buttons to align the cursor with "FTP" in the "CLIP" - "COPY" (→ page 93) menu item and press the [SET] button.

When copying proxy recordings only, select "FTP(PROXY)" for the "CLIP" - "COPY" menu item. Data other than the main line video and audio will be copied.

◆ Note:

The FTP EXPLORE screen will display clips without main line video and audio data as bad clips. Therefore, clips for which proxy copying was performed will be displayed as bad clips.

4 The server screen appears.

The folders on the set server are displayed. Use the cursor buttons to select the transfer destination folder.



◆ Note:

- Folder names using multi-byte characters are not displayed correctly.
- Press the [TC PRESET] button to add a new folder to the current folder list. (This operation is not related to the cursor position.) Numeric characters indicating the date and time are automatically entered for the name of the new folder but you can set a different name with the full keyboard. Note that some characters are not allowed on some FTP servers. A folder with the same name as an existing folder cannot be created.

5 Align the cursor with “YES” and press the [SET] button.

Copying begins.

(→ When importing on a clip basis, also refer to “Copying Clips” page 48.)

When copying is completed, “COPY COMPLETED!” appears.

◆ Note:

- Depending on the number of clips on the server and network conditions, it may take some time to display thumbnails or copy them.
- To stop copying, press the [SET] button, align the cursor with “YES” in the CANCEL confirmation message, and press the [SET] button. If the network is not disconnected, the partially copied clips at the copy destination are deleted. If the network is disconnected, incomplete clips may remain on the FTP server.
- After copying starts, disconnection errors will no longer be detected. Use the procedure above to stop a copy operation that has stalled.
- Confirm the amount of free space on the FTP server from your FTP server administrator in advance because it cannot be checked automatically before copying starts.
- Whether an error occurs when the remaining free space on the FTP server reaches 0 depends on the FTP server. If an error is not generated, use the procedure above to stop the operation.
- Clips cannot be copied to an FTP server folder that contains more than 1000 clips.
- To use SSH, the FTP server must be SSH compliant.
- Setting SSH to “ENABLE” will reduce the transfer speed.
- Before you can check the result of a transfer on a computer or other device, you may need to refresh the display on the computer or other device.
- If a file that exceeds 4 GB was recorded with the “FILE SPLIT” (→ page 98) menu item set to “ONE FILE,” that file cannot be copied.

Writing back from an FTP server (copy)

Selected clips can be written back from an FTP server on the network to a P2 card or hard disk.

- 1 Open the FTP thumbnail screen.
- 2 Select the clip to copy from the displayed thumbnails on the server.
- 3 Press the [MENU] button to display the menu. (→ “Menu Operations” page 89)
- 4 Use the cursor buttons to align the cursor with the “CLIP” - “COPY” (→ page 93) menu item and press the [SET] button.
- 5 Select the transfer destination (P2 slot or hard disk) from the menu list and start writing back the data.

◆ Note:

- Depending on the number of clips on the server and network conditions, it may take some time to display thumbnails or copy them.
- To stop copying, press the [SET] button, align the cursor with “YES” in the CANCEL confirmation message, and press the [SET] button. Partially copied clips at the copy destination are deleted.
- After copying starts, disconnection errors will no longer be detected. Use the procedure above to stop a copy operation that has stalled.
- Clips cannot be copied to a P2 card or hard disk folder that contains more than 1000 clips.
- To use SSH, the FTP server must be SSH compliant.
- Setting SSH to “ENABLE” will reduce the transfer speed.
- After an error occurs during an operation such as copying, the connection to the FTP server may be disconnected, resulting in the operation no longer being able to be continued. Should this happen, return to the FTP EXPLORE screen, display the FTP thumbnail screen again, and then restart the copying or other operation.

When copying is completed, “COPY COMPLETED!” appears.

Transferring SD Memory Card Data

The data in an SD memory card can be transferred to an FTP server, and then written back from the FTP server to the SD memory card.

Transferring to an FTP server (export)

1 Display the thumbnail screen.

2 Press the [MENU] button to display the menu.

(→ “Menu Operations” page 89)

3 Use the cursor buttons to align the cursor with the “CLIP” - “EXPORT” (→ page 93) menu item and press the [SET] button.

◆ **Note:**

- The “SD CARD” menu item can be selected only when a card is inserted in the SD memory card slot.
- For a card in an SD card slot, only the whole memory card can be exported. It is not possible to export selected clips like with a P2 card.

4 The server screen appears.

The folders on the set server are displayed. Use the cursor buttons to select the transfer destination folder.

◆ **Note:**

- Folder names using multi-byte characters are not displayed correctly.
- Press the [TC PRESET] button to add a new folder to the current folder list. (This operation is not related to the cursor position.)
Numeric characters indicating the date and time are automatically entered for the name of the new folder but you can set a different name with the full keyboard.
Note that some characters are not allowed on some FTP servers. A folder with the same name as an existing folder cannot be created.

5 Press the [SET] button to start exporting.

◆ **Note:**

- Exporting may take a long time depending on factors such as the number of files, file sizes, and network conditions.
- To stop exporting, press the [SET] button, align the cursor with “YES” in the “CANCEL” confirmation message, and press the [SET] button. If the network is not disconnected, the partially exported files on the FTP server are deleted. If the network is disconnected, incomplete files may remain on the FTP server.
- After exporting starts, disconnection errors will no longer be detected. Use the procedure above to stop an export operation that has stalled.
- Confirm the amount of free space on the FTP server from your FTP server administrator in advance because it cannot be checked automatically before exporting starts.

- Whether an error is generated when the remaining capacity of the FTP server reaches 0 depends on the FTP server. If an error is not generated, use the procedure above to stop the operation.
- When an existing folder is selected and that folder contains files with the same path names as files in the SD memory card, the files will be overwritten without any warning message being displayed. However, if the path names are the same but the types differ (folder and file), an error is generated.
- To prevent inadvertent overwriting, create new folders to export data whenever possible.
- To use SSH, the FTP server must be SSH compliant.
- Setting SSH to ENABLE will reduce the transfer speed.

When exporting is completed, “COPY COMPLETED!” appears.

Writing back from an FTP server (import)

A folder selected from an FTP server on the network can be written back to an SD memory card.

- 1 Display the FTP EXPLORE screen.
- 2 The folder screen of the FTP server appears.
The folders on the set server are displayed. Use the cursor buttons to select the transfer source folder.
- 3 Press the [MENU] button to display the menu.
(→ “Menu Operations” page 89)
- 4 Use the cursor buttons to align the cursor with the “IMPORT” (→ page 93) menu item and press the [SET] button.
Press “OK” in the SD IMPORT confirmation dialog box that appears to start writing back the data to the SD memory card.

◆ Note:

- To stop importing, press the [SET] button, align the cursor with “YES” in the “CANCEL” confirmation message, and press the [SET] button. Partially imported files in the SD memory card are deleted, but successfully imported files remain.
- After importing starts, disconnection errors will no longer be detected.
Use the above procedure to stop an import operation that has stalled.
- Writing back may take a long time depending on factors such as the number of files, file sizes, and network conditions.
- Any files with the same path names on the SD memory card will be overwritten without any warning message being displayed. However, if the path names are the same but the types differ (folder and file), an error is generated.
- To prevent inadvertent overwriting, format the SD memory card before importing whenever possible.
- To use SSH, the FTP server must be SSH compliant.
- Setting SSH to “ENABLE” will reduce the transfer speed.

When importing is completed, “COPY COMPLETED!” appears.

Rec during upload function

Clips recorded in the P2 card can be automatically transferred to a server device on the network during recording/playback with the unit.

The rec during upload function has the following two modes:

- Automatic transfer mode:
Uploads recorded clips in order after the rec during upload function is enabled.
- Manual selection mode:
Uploads clips selected beforehand.

To use the rec during upload function, network settings and FTP client settings need to be configured beforehand.

Transferring recorded clips automatically (automatic transfer mode)

- 1 Establish the network connection between the unit and a server device.
Refer to “Client settings” (→ page 71) for the settings.
- 2 Set the unit's menu - “REC DURING UPLOAD” (→ page 105) to “ENABLE”.
- 3 Select the type of clip to upload in the unit's menu “AUTO UPLOAD” (→ page 105).
REC CLIP (PROXY):
Upload target is proxy data of recorded clips.
REC CLIP:
Upload target is recorded clips (main recording data and proxy data).
DISABLE:
Recorded clips are not upload targets.
- 4 Record.

Clips are registered in the upload list immediately after recording is stopped, and then recorded clips are automatically transferred.

The LCD monitor shows the operation status of the rec during upload function. In addition, the thumbnail screen shows the operation status of the rec during upload function and the transfer status of clips.

◆ Note:

- Upload of the clip will start after the rec during upload is set to enable. To prevent the upload error, do not remove the card from the P2 memory card slot and the microP2 memory card slot before the transfer finishes.
- Up to 100 clips can be registered in the upload list for the upload of clips. Clips exceeding 100, excluding the uploaded clips and clips failed to upload cannot be registered.
- While recording is stopped, you can add recorded clips to transfer. From the thumbnail screen, select the menu - “CLIP” - “COPY” - “FTP” or “FTP(PROXY)”, and then select clips to transfer. The selected clips are registered in the upload list.
- Clips are also automatically transferred during recording, playback, and thumbnail display.
- If “SHORT SPLIT” is selected in the “FILE SPLIT” menu item (→ page 98) when using the rec during upload function, the split unit of the recording file will become smaller, making the timing at which clip transfer starts earlier.
- If the network is disconnected during transfer, or the power of the unit is turned off and on again, transfer resumes in clip units.
- During simultaneous recording, only the recorded clips in slot 1 are transferred automatically.
- Clips of loop recording are not transferred automatically.
- While the rec during upload function is enabled, the last clip delete function is disabled.
- The directory on the FTP server is not listed in the FTP explorer screen during the transmission or waiting to transmit the clips registered in the upload list.
- While the rec during upload function is enabled, the setting values in the menu “NETWORK” (→ page 105) cannot be changed or initialized.
- The copying between the P2 cards will not operate during the transmission or waiting to transmit the clips registered in the upload list.
- The clip delete function will not operate during the transmission or waiting to transmit the clips registered in the upload list.
- The format function of the P2 card will not operate during the transmission or waiting to transmit the clips registered in the upload list.
- If a file that exceeds 4 GB was recorded with the “FILE SPLIT” (→ page 98) menu item set to “ONE FILE,” that file cannot be copied.

Transferring selected clips automatically (manual selection mode)

- 1** Establish the network connection between the unit and a server device.
Refer to “Client settings” (→ page 71) for the settings.
- 2** Set the unit’s menu “REC DURING UPLOAD” (→ page 105) to “ENABLE”.
- 3** Set the unit’s menu “AUTO UPLOAD” (→ page 105) to “DISABLE”.
- 4** From the thumbnail screen, select the main menu “CLIP” - “COPY” - “FTP” or “FTP (PROXY)”, and then select clips to transfer.



Selected clips are registered in the upload list, and transferred automatically.

You can check the transfer status of clips registered in the upload list in the menu “UPLOAD LIST” (→ page 105). The viewfinder or LCD monitor shows the operation status of the rec during upload function. In addition, the thumbnail screen shows the operation status of the rec during upload function and the transfer status of clips.

◆ Note:

- The clips selected with the manual selection mode will be transferred prioritized to the clips registered to the upload list with the automatic transfer mode.
- Upload of the clip will start after the rec during upload is set to enable. To prevent the upload error, do not remove the card from the P2 memory card slot and the microP2 memory card slot before the transfer finishes.
- Up to 100 clips can be registered in the upload list for the upload of clips. Clips exceeding 100, excluding the uploaded clips and clips failed to upload cannot be registered.
- Clips are also automatically transferred during recording, playback, and thumbnail display.
- If the network is disconnected during transfer, or the power of the unit is turned off and on again, transfer resumes in clip units.
- While the rec during upload function is enabled, the streaming function is disabled.
- The directory on the FTP server is not listed in the FTP explorer screen during the transmission or waiting to transmit the clips registered in the upload list.

- While the rec during upload function is enabled, the setting values in the menu “NETWORK” (→ page 105) cannot be changed or initialized.
- The copying between the P2 cards will not operate during the transmission or waiting to transmit the clips registered in the upload list.
- The clip delete function will not operate during the transmission or waiting to transmit the clips registered in the upload list.
- The format function of the P2 card will not operate during the transmission or waiting to transmit the clips registered in the upload list.
- If a file that exceeds 4 GB was recorded with the “FILE SPLIT” (→ page 98) menu item set to “ONE FILE,” that file cannot be copied.

Displaying the upload list

The upload list allows you to check the transfer status of clips to be uploaded.

1 Select the menu “UPLOAD LIST” (→ page 105).

The upload list is displayed.

■ Upload list screen

| | 1) | 2) | 3) | 4) | |
|-------|--------------|--------|------|--------------|-------|
| | CLIP NAME | STATUS | SIZE | LAST UPDATE | |
| PAINT | EXIT | | | | 5, 14 |
| VF | 02938V[AUTO] | PAUSE | 210M | Dec 05 03:29 | |
| CAME | 02944L[AUTO] | WAIT | 179M | Dec 05 03:32 | |
| CLIP | 0295KN[AUTO] | WAIT | 389M | Dec 05 03:32 | |
| REC/ | 0296NP[AUTO] | WAIT | 153M | Dec 05 03:33 | |
| I/F S | 0297NR[AUTO] | WAIT | 298M | Dec 05 03:33 | |
| FILE | 0298ST[AUTO] | WAIT | 273M | Dec 05 03:33 | |
| MAIN | 02998G[AUTO] | WAIT | 231M | Dec 05 03:34 | |
| SYST | 0300CL[AUTO] | WAIT | 199M | Dec 05 03:34 | |
| USER | | | | | |

[SET] DELETE or CANCEL or RETRY
[SHIFT+RESET] DELETE ALL
[SHIFT+EXIT] CLEAR HISTORY

1) CLIP NAME

Displays clip names. For the clip where automatic transfer is set, “AUTO” is displayed after the clip name.

2) STATUS

Displays the upload status.

OK: Uploaded

ERROR: Upload failed

PAUSE: Preparing the upload

COPY: Uploading

WAIT: Waiting for upload

3) SIZE

Displays the file size.

4) LAST UPDATE

Displays the date and time “STATUS” display changed.

■ Operations on the upload list screen

You can delete, cancel, or re-transfer items from the upload list.

1 Use the up or down cursor button to select an item in the upload list and then press the [SET] button.

2 Perform one of the following operations.

- To delete the item, use the up or down cursor button to select [DELETE].
- To cancel the upload, use the up or down cursor button to select [CANCEL].
- To re-transfer the item, use the up or down cursor button to select [RETRY].
- To delete all items, press the [SHIFT] button and the [RESET] button simultaneously. A confirmation screen appears. Use the up or down cursor button to select [YES]. The current log of the clip information registered to the upload list will also be deleted at this time.
- To delete the history (items of which [STATUS] is [OK] or [ERROR]), press the [SHIFT] button and [EXIT] button at the same time. A confirmation screen appears. Use the up or down cursor button to select [YES].

◆ Note:

- If the [STATUS] display changes while displaying the upload list, the screen is not updated.
- Save up to the latest 1000 logs for clip information (month and date, clip number (global clip ID), status) registered in the upload list to an SD memory card.

USB Device Mode

A USB 2.0 connection with a computer or other device allows you to use the P2 cards inserted in the P2 card slots of this unit as mass storage devices. Note that a separate USB driver, which can be downloaded free of charge from the Panasonic website, needs to be installed on the computer. (→ “Website URL” page 9)

You can use P2 Viewer Plus, which can be downloaded free of charge from the Panasonic website, to manipulate clips stored on P2 cards.

For the URL (→ “Website URL” page 9)

◆ **Note:**

For details on connecting, refer to the operating instructions supplied with your computer and software.

1 Press the [MODE] button when the unit is in the idle state.

2 Align the cursor (*) with “USB DEVICE” in the selection screen and press the [SET] button.



“USB DEVICE” flashes on the LCD monitor and the unit switches modes. After the mode is switched, “USB DEVICE CONNECTING...” appears on the LCD monitor. This message is replaced with the “USB DEVICE CONNECT” message when the connection with the computer is completed.

3 Perform operations in USB device mode.

◆ **Note:**

Please refer to the operating instructions supplied with your computer and software.

4 Press the [MODE] button to return to regular mode.

◆ **Note:**

Recording, playback, and most other operations are not available in USB device mode.

P2 Playlist Editing Mode

■ Starting the application (P2 Playlist Editor) from the Web browser

When the network connection with the mobile device or computer is established, start the browser on the mobile device or computer and then start the application (P2 Playlist Editor).

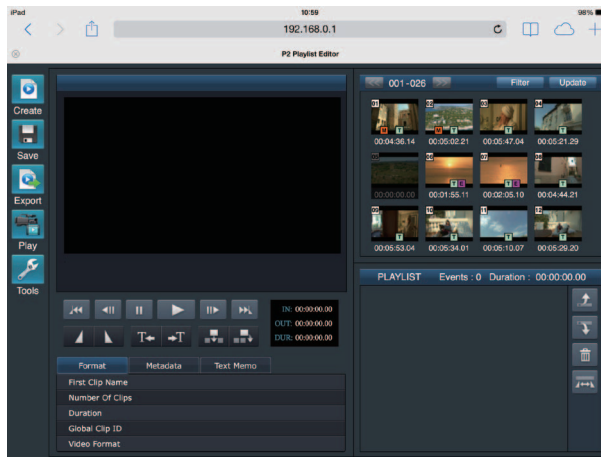

Fig. 1

1 Press the [MODE] button when the unit is in the idle state.

2 Align the cursor(*) with “PLAYLIST” in the selection screen and press the [SET] button.

“PLAYLIST” flashes on the LCD monitor and the modes changes. When the mode changes, “PLAYLIST” appears in the additional information display area on the LCD monitor.

3 Start the browser (Safari or Internet Explorer) on the mobile device or computer.

4 Enter the IP address set for the unit in the address bar of the browser.

- Factory default setting: 192.168.0.1

5 Press the Enter key in the case of a computer and tap the GO button in the case of an iPad or iPhone.

The Web application (P2 Playlist Editor) starts.

6 When the authentication screen appears, enter the user name and password in the input screen.

Enter the value set for “USER ACCOUNT” (factory default setting: guest) and the value set for “PASSWORD” (factory default setting: p2guest) on the unit.

The connection is established when the screen in Fig. 1 appears.

You can set a user account name and password in the “USER ACCOUNT” (→ page 105) menu setting.

You can register a new account, delete an account, or change a password in the “ACCOUNT LIST” (→ page 105) menu setting.

The user account name can be up to 31 characters long and the password can be from 6 to 15 characters long. For information on P2 Playback Editor, refer to Operating Instructions of P2 Web Application available from the following website.

<https://pro-av.panasonic.net/manual/en/index.html>

◆ Note:

- When “NETWORK SEL” is “WLAN,” “4G/LTE,” or “LAN,” the startup time when the power is turned on may be longer than usual due to the network function starting.
- When “NETWORK SEL” is set to “OFF,” the network function will not be available.
- When the “NETWORK SEL” setting is changed, the change is not applied until the unit is restarted. When the setting is changed, it may take a while for the settings screen to close because the network service is restarted.
- The combination of the IP address, subnet mask, and default gateway must be correct. If the “CANNOT ACCESS GATEWAY!” warning appears as the setup screen closes, contact your network administrator.
- When a default gateway and DNS will not be used, set the settings to “0.0.0.0.”
- DHCP and DNS may not operate properly in some network environments.
- Only one client can be connected at a time during playlist editing mode.

7 Press the [MODE] button to return to regular mode.

◆ Note:

Recording, playback, and most other operations are not available in playlist editing mode.

Screen Display

OSD Display

The OSD screen display toggles on and off each time you press the [DISPLAY] button.

The formats, time codes, and modes are displayed as abbreviations on the playback and recording screens.

◆Note:

- Select whether to display the level meter on this display in the “OSD GRADE” (→ page 108) menu item. You can also select the display items in the “OSD TC SELECT” (→ page 108) menu item.
- Switch the output destination to display in the “OSD OUTPUT” (→ page 108) menu item.
- You can change the display position of time codes and other indicators that appear at the bottom of the screen in the “CHARA V POSI” menu item (→ page 108).

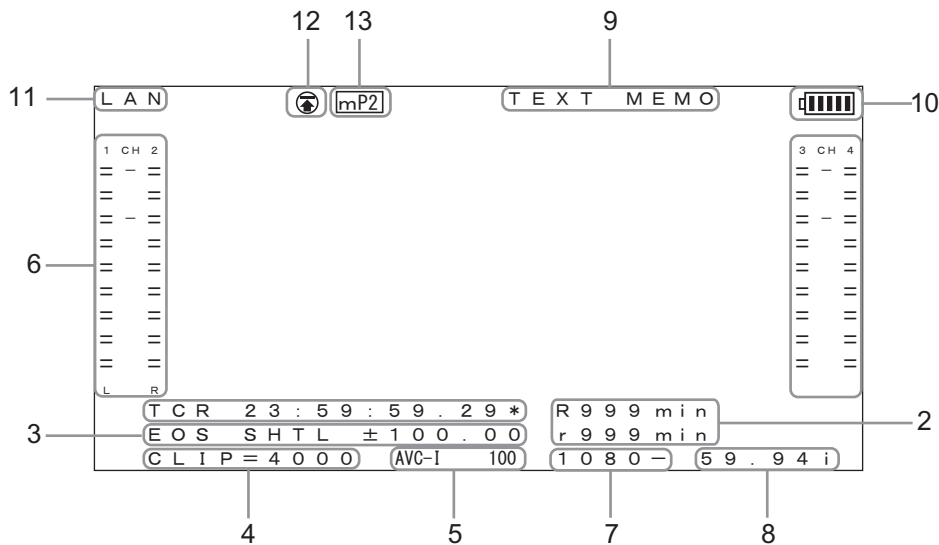

1. Time codes and other displayed information

| | |
|------|---|
| CTL | Relative location from the beginning |
| TCR | Recorded time code data |
| TCR. | Time code data recorded in the VAUX area |
| UBR | Recorded user bit data |
| UBR. | User bit data recorded in the VAUX area |
| TCG | Time code data of the time code generator |
| UBG | User bit data of the time code generator |
| TIME | Time information recorded in the subcode |
| DATE | Date information recorded in the subcode |

◆Note:

- “T*R” or “U*R” is displayed when data could not be read from a P2 card properly.
- “*” is displayed after the frames in the 2nd and 4th fields.
- In drop-frame mode, a period “.” is used instead of a colon “:” after seconds.

2. Remaining space on the card

The remaining space (available recording time) on the card is indicated in minutes.

R*** indicates the amount of remaining recording space.
r*** indicates the amount of remaining proxy recording space.

◆Note:

- 600 minutes and longer time periods are indicated in hours with an “h” appended after the number.
- When the remaining time and card length information are not defined, the indication is blank.
- Time exceeding 99 hours is indicated as 99 h.
- When recording to an SD memory card with proxy recording is not possible (for example, when the remaining space on the SD memory card is 0), “r***” (remaining proxy recording space) flashes.

3. Operating status display

Indicates the current deck status.

4. Clip number

Indicates the clip number of the displayed thumbnail.

5. Compression format display

Indicates the compression format during recording or recording standby.

Indicates the compression format of the current clip during playback.

6. Audio level meter display

Indicates the input level during recording or recording standby and the audio level of the current clip during playback.

- When the "OSD GRADE" (→ page 108) menu item is set to "NO LVL METER," the audio level meter is not displayed.

7. System format display

Indicates the system format of the setup menu during recording or recording standby.

Indicates the system format of the current clip during playback.

8. System frequency display



Indicates the system frequency.

9. Additional information display

When the "OSD TC SELECT" menu item (→ page 108) is set to other than "T&S&M," a message is displayed when TEXT MEMO and MARKER are added. Also, "PLAYLIST" is always displayed when in playlist editing mode and "INT LOCK" is always displayed when the "INT LOCK MODE" menu item (→ page 115) is enabled.

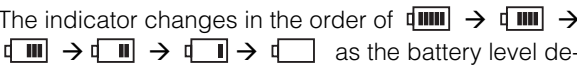
10. Battery level indicator

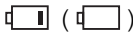
The indicator changes in the order of  as the battery level decreases.

When there is no battery power remaining,  () flashes.







(When the AC adaptor is connected,  is displayed.)

In a location in which the temperature becomes low or high or if the battery has not been used for a long time, the battery level indicator may not be displayed correctly. To display the battery level correctly, fully charge the battery and then use up the charge and recharge the battery. (Even if this operation is performed, the battery level indicator may not be displayed correctly for a battery that has been used for a long time in a location in which the temperature becomes low or high or a battery that has been changed many times repeatedly.)



Treat the indication as an estimate as the timing of the battery level indicator varies depending on the operating conditions.

11. Network status indicator

Indicates the status of the network function.

- WLAN: Connected to wireless LAN (linked state)
- WLAN : Not connected to wireless LAN (unlinked state)
- WLAN : Error with wireless LAN connection
- LAN: Connected to wired LAN (linked state)
- LAN : Not connected to wired LAN (unlinked state) or when error
- 4G/LTE : Connected via 4G/LTE
- 4G/LTE : Not connected via 4G/LTE
- 4G/LTE : Error with 4G/LTE connection
- No display: Network function is disabled

◆ Note:

- The appearance of "" may indicate that a cable, the USB modem, or other device is not connected. Check the connection status (cable and USB modem) and signal reception status.
- The appearance of "" or "" may indicate a problem with connections. Check whether the proper equipment has been connected and whether the settings have been configured properly.

12. Rec during upload status display and streaming distribution status display

Indicates the transfer status of the FTP automatic transfer (rec during upload) function and the distribution status of the streaming distribution function.



Displays when the rec during upload function is enabled.

The display will flash immediately after the power is turned on or the P2 card is inserted and recording is started, and the upload will not be executed until the recording is stopped.



Displayed during upload.



Displayed from when transfer error occurred during upload until when the next upload starts.



(Flashing)

Flashes while the unit is being connected to a device which will receive the streaming video.



(Lit)

Displayed when the unit is connected to a device receiving the streaming video and the unit is transmitting streaming video. The display turns off when a connection could not be established properly.

13. Recording media display

Among P2 and microP2 memory card slots, displays the slot that can perform recording and playback operations set in the menu "REC MEDIA" (→ page 98).

| | |
|-----|---------------------------|
| P2 | P2 memory card slots |
| mP2 | microP2 memory card slots |

Deck Information (DIAG) Display

This displays the deck information. Deck information includes [USER] button and warning information.

1 Press the [DIAG] button.

The [USER] button setting information appears. After information is displayed the first time, the page displayed the last time will open from the next time.

◆Note:

- This information is not displayed when a menu is displayed.
- Switch the output destinations to display in the "GUI OUTPUT" (→ page 108) and "OSD OUTPUT" (→ page 108) menu settings.
- Playback and other operations are not available during DIAG display.

2 Press the left or right cursor button.

The information displayed changes with each press of the button.



Information displayed

USER BUTTON:

Indicates the functions assigned to the USER buttons 1 to 6 and currently set values.

WARNING:

Warning and error information

(→ "Display of warning information" page 120)

3 Press the [DIAG] button.

The previous display is redisplayed.

You can also return to the previous display by pressing the [EXIT] or [MENU] button.

Waveform Monitor (WFM) Display

This displays a simple waveform monitor on the screen for monitoring video. It can be displayed by setting the "WFM TYPE" (→ page 108) menu item.

WAVE: Waveform display

VECTOR: Vector display

◆Note:

- Switch the output destination to display in the "OSD OUTPUT" (→ page 108) menu item.
- This information is not displayed when a menu or thumbnail is displayed.

Time Code, User Bits, and CTL

Time code

The time code is used when the time code signal generated by the time code generator is to be recorded. The time code values are indicated on the display and in the superimposed display.

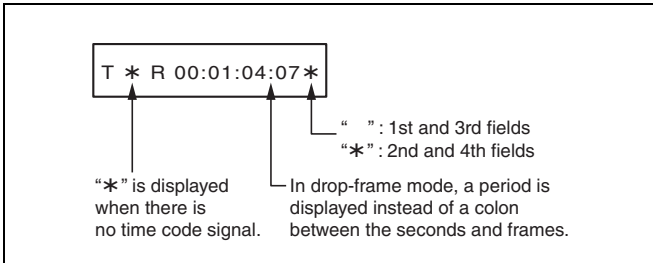

User Bits

"User bits" refers to the 32-bit (8 digits) section of the time code data that is made available to the user. It allows you to record operator numbers and other values. The alphanumeric characters that can be used in the user bits are 0 to 9 and A to F.

CTL

During playback, the counter displays the playback position relative to the start position. Recording starts from the "0:00:00:00" counter value. When recording stops, the counter shows the current position relative to the start position.

Setting the Time Code and User Bits

Internal mode

- 1** Switch to stop mode.
Press the [STOP]  button to switch to stop mode.
- 2** Use the [COUNTER] button to select "TC" or "UB."
- 3** Set the run mode of the time code generator in the "RUN MODE" (→ page 100) menu item.

| | |
|-----------|--|
| REC RUN: | Advances the time code during recording. |
| FREE RUN: | Advances the time code regardless of operating mode. |

- 4** Set each mode for TC and UB in the "TCG MODE" (→ page 100) and "UBG MODE" (→ page 100) menu items.

| | |
|---------|---|
| REGEN: | Maintains the continuity with the time code last recorded on a P2 card. |
| PRESET: | Starts recording from the value set with the [TC PRESET] button. |
| EXT: | Records according to external time code input. |

- 5** Use the [TC PRESET] button to set the start values of the time code and user bits.

How to set TC/UB:

- 1**) Press the [TC PRESET] button.
The left-most digit starts flashing.
- 2**) Press the up or down cursor button to change the value.
- 3**) Press the left or right cursor button to select the digit to set.

The selected digit starts flashing.
The setting ranges are as follows.

| | |
|------------|---|
| Time code: | <59.94 Hz><29.97 Hz> 00:00:00:00 - 23:59:59:29 |
| | <50 Hz><25 Hz> 00:00:00:00 - 23:59:59:24 |
| User bits: | 00 00 00 00 - FF FF FF FF |

- 6** Repeat 2) to 3) of step 5 to change the other value.
Pressing the [RESET] button resets the preset value to 0.

7 When you finish setting the start values, press the [SET] button.

When the "RUN MODE" (→ page 100) menu item is set to "FREE RUN," the time code starts advancing immediately. To cancel this setting, press the [EXIT] button or [CANCEL] button.

■ Time code when no power is supplied

When no power is supplied, the backup function works to enable the time code generator to provide long-term (about three months) operation.

◆ Note:

- If backing up becomes no longer possible because the unit has not been used for a long period of time, the "BACKUP BATT EMPTY" warning will be displayed when the power of the unit is turned on and the date and time of the unit will need to be set again. (See "Setting the Year, Month, Day, and Time" page 25 and "BACKUP BATT EMPTY" page 121.)
- When the setting of the "LINE&FREQ" (→ page 114) menu item is changed, the run data is cleared.

External mode

1 Press the [STOP]  button to switch to stop mode.

2 Use the [COUNTER] button to select "TC."

3 Set the "TCG MODE" (→ page 100) and "UBG MODE" (→ page 100) menu items to "EXT."
(External time code selection)

4 Select the external input time code type in the "EXT TC SEL" (→ page 100) menu item.

| | |
|-----------|---|
| EXT LTC: | Records the LTC signals input to the TIME CODE IN connector (BNC) on the rear panel. |
| S/H LTC: | Records the LTC signals added to the signals input to the SDI IN connector or HDMI IN connector. |
| S/H VITC: | Records the VITC signals added to the signals input to the SDI IN connector or HDMI IN connector. |

◆ Note:

When "S/H LTC" or "S/H VITC" is set and "SD SDI" is selected as the input signal, the VITC of the input video signal is recorded.

Setup Menu

Menu Operations

Operate the menu as follows.

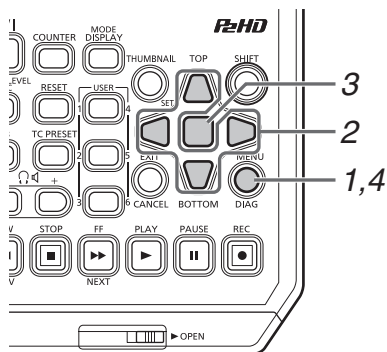

1 Press the [MENU] button to display the menu.

2 Use the cursor buttons to align the cursor with the corresponding menu item.

“▶” appears where a lower-level menu exists.

◆ **Note:**

- Use the up and down cursor buttons to move the cursor up and down.
- Press the right cursor button or [SET] button to open a lower-level menu.
- Press the left cursor button or [EXIT] button to return to a higher-level menu.

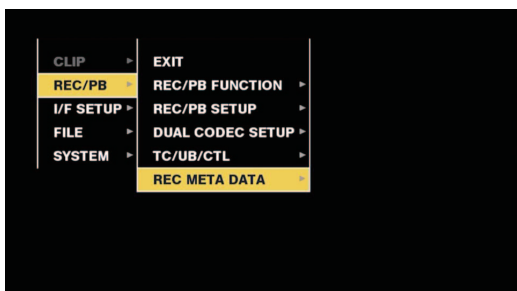
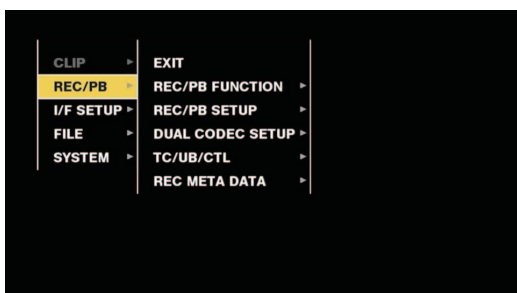

3 Press the [SET] button.

◆ **Note:**

- A confirmation screen is displayed for some menu items.
- Use the cursor buttons to select a process and press the [SET] button.
- A check mark is displayed before a set item.
- A screen for setting a numerical value is displayed for some menu items.
- Changing the system frequency requires rebooting the unit.
- In some menus, a message is displayed if a menu cannot be executed.

4 Press the [MENU] button to exit the menu.

◆ **Note:**

The previous screen is displayed automatically for some menu items.

For how to save and load set data or set the factory default state, refer to page 112 to 113.

Menu Structure

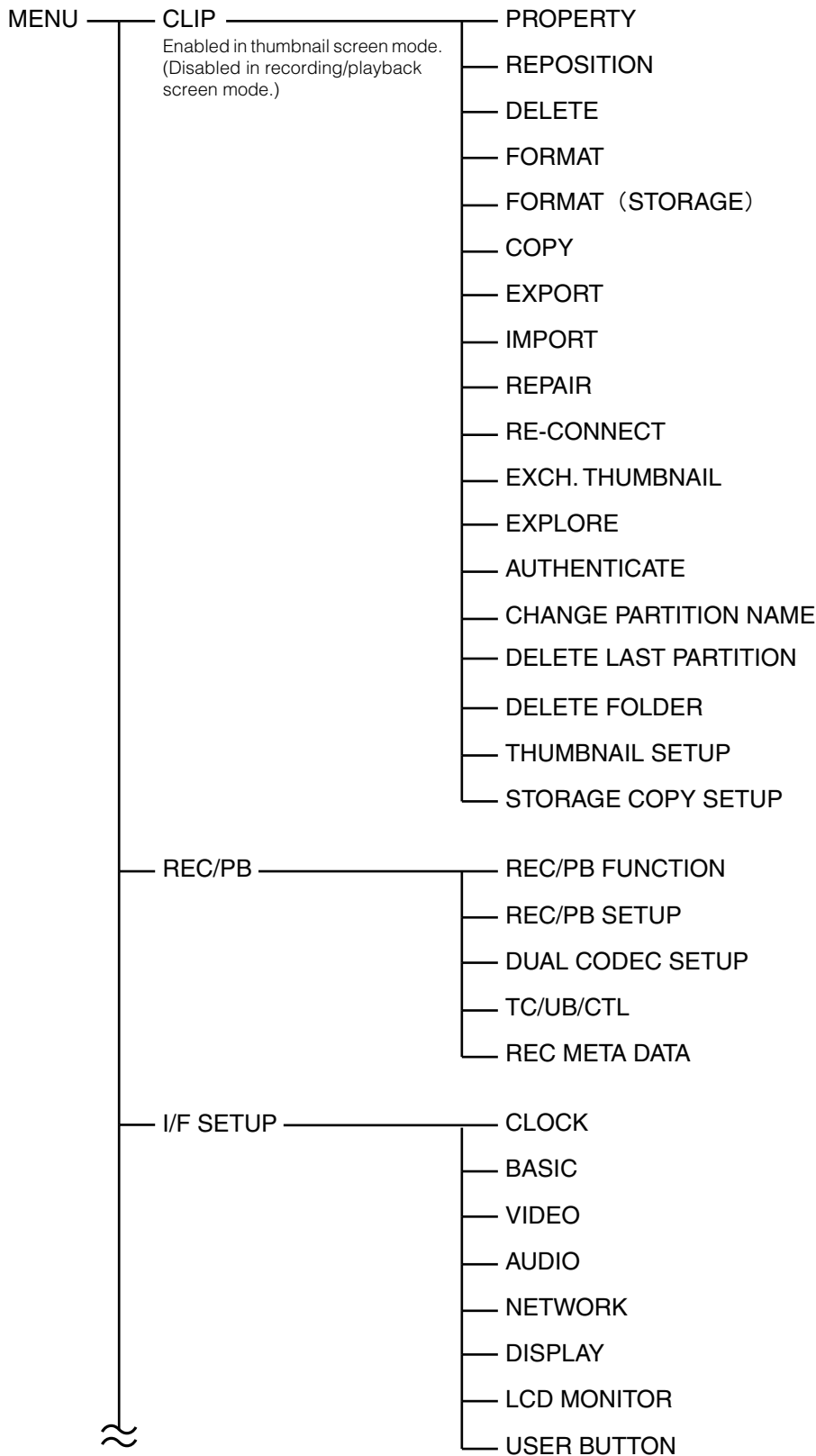

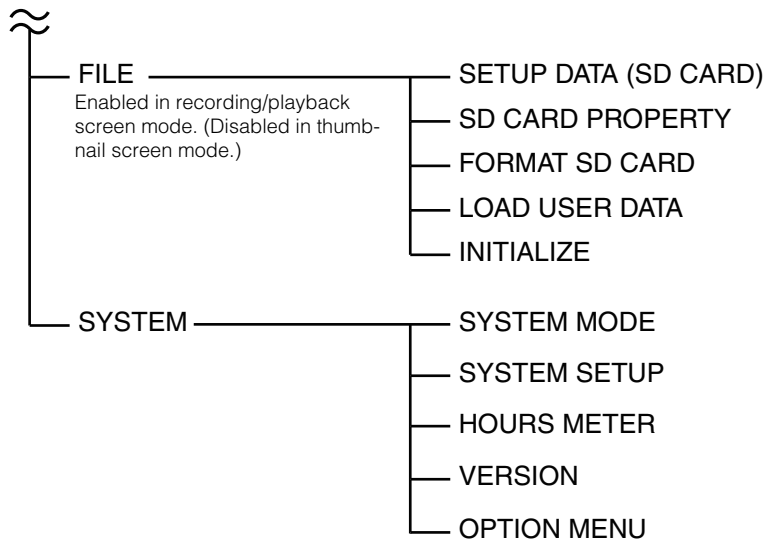

Menu List

CLIP

The CLIP menu is enabled in thumbnail screen mode. (It is disabled in recording/playback screen mode.)

PROPERTY

CLIP > PROPERTY

_ is the factory default setting.

| Item | Settings and brief function description | FREQ indications |
|------------------------|--|----------------------------|
| CLIP PROPERTY | Displays detailed clip information on the screen. Individual items can also be edited. For details, refer to "Viewing and Editing the Clip Information" (→ page 50). | 59.94Hz 50Hz |
| CARD STATUS | Displays the card status of the P2 card slots. For details, refer to "Checking the Card Status" (→ page 54). | 59.94Hz 50Hz |
| CPS PASSWORD | Sets the CPS encryption password for microP2 memory cards. LOAD: Loads the CPS password from an SD memory card. SET: Enter a CPS password. DELETE: Deletes the password stored on the unit and disables the encryption format. | 59.94Hz 50Hz |
| SD CARD | Displays SD memory card information. "SD CARD PROPERTY" (→ page 111) | 59.94Hz 50Hz |
| REMAIN SETUP | Sets whether to display the remaining free space or used space when displaying P2 card information. REMAIN: Remaining free space indication USED: Used space indication | 59.94Hz 50Hz |
| FREE CAP. OF PARTITION | Displays the free space on a partition. Note: This is displayed while the thumbnail screen for the [TYPE S] storage device is displayed. | 59.94Hz 50Hz |

CLIP > PROPERTY

_ is the factory default setting.

| Item | Settings and brief function description | FREQ indications |
|------------|---|----------------------------|
| REPOSITION | Selects the clips to display in the thumbnail screen. ALL CLIP: Displays thumbnails for all clips. SAME FORMAT CLIP: Displays thumbnails only for clips recorded in the same format as the system format and with the same audio bit rate as that set in the "AUDIO SMPL RES" (→ page 114) menu item. SELECTED CLIPS: Displays thumbnails only for clips selected using the [SET] button. The thumbnails are displayed in the order of selection. MARKED CLIPS: Displays thumbnails only for clips with shot marks added. TEXT MEMO CLIPS: Displays thumbnails only for clips with text memo data. SLOT CLIPS: Displays only clips in selected slots as thumbnails. NG CLIPS: Displays only the clips with the defective clip indicator as thumbnails. | 59.94Hz 50Hz |
| DELETE | Deletes the selected clips. Note: To stop deletion, press the [SET] or [CANCEL] button to cancel the operation. Partially deleted clips cannot be restored even if you cancel deletion. | 59.94Hz 50Hz |

CLIP > PROPERTY (Continued)

| Item | Settings and brief function description | FREQ indications |
|------------------|--|-----------------------------------|
| FORMAT | <p>After selecting the "FORMAT" menu item, format the P2 card in the P2 card slot to be specified or SD memory card in the SD memory card slot.</p> <p>Note:</p> <ul style="list-style-type: none"> • If a microP2 card is inserted in the P2 card slot, you can select "NORMAL" (normal un-encrypted format) or "CPS (ENCRYPT)" (encrypted format) when a CPS password is set. • Be sure to check the data before formatting since data erased by formatting cannot be recovered. | <p>59.94Hz 50Hz</p> |
| FORMAT (STORAGE) | <p>Formats the storage device connected by USB. "Storage device types and available functions" (→ page 57)</p> <p>TYPE S: Formats in the TYPE S format.</p> <p>FAT: Formats in the FAT format.</p> <p>Note:</p> <p>This is enabled only when storage explorer or storage thumbnails.</p> | <p>59.94Hz 50Hz</p> |
| COPY | <p>Copies the selected clips to a P2 card in any P2 card slot, to a storage device, or to an FTP server.</p> <p>Note:</p> <ul style="list-style-type: none"> • Do not turn off the power or remove/insert a card during copying. Doing so may result in a bad clip. If a bad clip is created, delete it and perform copying again. • Reconnect incomplete clips before copying. | <p>59.94Hz 50Hz</p> |
| EXPORT | <p>Exports (writes) the data by card from P2 cards or SD memory cards to a storage device or the LAN.</p> <p>ALL SLOT, SLOT1 to SLOT3: Exports the data from P2 cards to a storage device.</p> <p>SDCARD: Exports the data from SD memory cards to the LAN.</p> | <p>59.94Hz 50Hz</p> |
| IMPORT | <p>Imports (writes back) clips and other data by card from a storage device or the LAN to P2 cards or SD memory cards.</p> <p>Note:</p> <ul style="list-style-type: none"> • This is enabled only for TYPE S storage devices. • Data cannot be written back to a P2 card that does not have the same model number as the original P2 card. • This is displayed only when storage explorer or FTP explorer. | <p>59.94Hz 50Hz</p> |
| REPAIR | <p>Repairs clips indicated by the bad clip indicator (NG) that were damaged by, for example, a sudden power outage during recording.</p> <p>Note:</p> <p>Some clips may be so badly damaged they cannot be repaired. Bad clips that are beyond repair are indicated by a red indicator (NG).</p> | <p>59.94Hz 50Hz</p> |
| RE-CONNECT | <p>Use this reconnection function to rejoin continuous clips that span across multiple P2 cards but are not recognized as continuous clips and are indicated by the incomplete clip indicator (!).</p> <p>Note:</p> <ul style="list-style-type: none"> • Incomplete clips occur under the following conditions. <ul style="list-style-type: none"> - When the segments of a continuous clip that are recorded on multiple P2 cards are copied separately for each P2 card. - When the segments of a continuous clip that are recorded on multiple cards are copied separately for each card to a storage device and then written back to the P2 cards. • When some but not all the clip segments in a clip that consists of three or more clip segments are reconnected, the incomplete clip mark indicator (!) will remain displayed. | <p>59.94Hz 50Hz</p> |
| EXCH. THUMBNAIL | <p>Changes the clip thumbnail to an image at any text memo position. This function can be executed when a text memo clip is displayed.</p> | <p>59.94Hz 50Hz</p> |
| EXPLORE | <p>Switches to a screen that shows various information on storage device or LAN.</p> <p>STORAGE: Switches to a screen that shows various information on storage device.</p> <p>LAN: Switches to a screen that shows various information on the LAN.</p> | <p>59.94Hz 50Hz</p> |
| AUTHENTICATE | <p>Selecting this menu item from the card status screen displays the soft keyboard for entering the CPS password. Enter a password and select "OK" to set the CPS password on the unit. When authentication with the set CPS password is successful, the "AUTHENTICATED SUCCESSFULLY!" message appears.</p> <p>When authentication with the set CPS password fails, a warning message (→ page 120) appears.</p> | <p>59.94Hz 50Hz</p> |

CLIP > PROPERTY (Continued)

| Item | Settings and brief function description | FREQ indications |
|-----------------------|--|----------------------------|
| CHANGE PARTITION NAME | Sets or changes the names of partitions in a storage device. Note: <ul style="list-style-type: none"> The default value is the date and time when the partition was created. This is enabled only for TYPE S storage devices. This is displayed only when storage explorer. | 59.94Hz 50Hz |
| DELETE LAST PARTITION | Deletes the last partition on a storage device. Note: <ul style="list-style-type: none"> Deletion is possible only when the cursor is on the last partition. This is displayed only when storage explorer. | 59.94Hz 50Hz |
| DELETE FOLDER | Deletes a folder on a storage device in FAT format. Note: Displayed only in storage explorer | 59.94Hz 50Hz |

THUMBNAIL SETUP

CLIP > THUMBNAIL SETUP

_ is the factory default setting.

| Item | Settings and brief function description | FREQ indications |
|----------------|---|----------------------------|
| INDICATOR | Select any of the following items you want to display and press the [SET] button to add a check mark to the item. When "ALL HIDE" is selected, other items cannot be selected. ALL HIDE: Hides all of the indicators. MARKER: Displays the shot marker indicator. TEXT MEMO: Displays the text memo indicator. WIDE: Displays the wide indicator. PROXY: Displays the proxy indicator. Note: Regardless of the above settings, the bad clip indicator (NG)/(NG), unknown clip indicator, and incomplete clip indicator are always displayed. | 59.94Hz 50Hz |
| DATA DISPLAY | Selects the items to display in the time display. TC: Time code UB: User bits TIME: Time of recording DATE: Date of recording DATE TIME: Date and time of recording CLIP NAME: Clip name USER CLIP NAME: Up to the first fifteen characters in the user clip name SLOT: Slot number THUMBNAIL TC: Time code of thumbnail position | 59.94Hz 50Hz |
| THUMBNAIL SIZE | Sets the size of thumbnails displayed on the screen in thumbnail mode. SMALL: Small (thumbnail display 4 x 3, property display) MEDIUM: Standard (thumbnail display: 4 x 3) LARGE: Large (thumbnail display: 3 x 2) | 59.94Hz 50Hz |
| PB POSITION | Sets the playback start position for playback on the thumbnail screen. RESUME: Plays from the position where playback was stopped. THUMBNAIL TC: Plays from the time code of the thumbnail position. START TC: Plays from the start time code (beginning of the clip). | 59.94Hz 50Hz |
| SORT | Sets the display order for thumbnails. OFF: Recorded order SLOT: Slot order (clips in the same slot are displayed according to the date and time of recording) | 59.94Hz 50Hz |

CLIP > THUMBNAIL SETUP (Continued)

| Item | Settings and brief function description | FREQ indications |
|------------------|---|-----------------------------------|
| PROPERTY DISP. | <p>Sets the items to display in the simplified property display on the left side of the thumbnails.</p> <p>USER CLIP NAME: Indicates the name of a user clip</p> <p>START TC: Indicates the start time code.</p> <p>REC DATE: Indicates the date of recording.</p> <p>REC TIME: Indicates the time of recording.</p> <p>NUM. OF AUDIO CH: Indicates the number of audio channels.</p> <p>AUDIO RATE: Indicates the audio sampling rate.</p> <p>AUDIO BIT: Indicates audio bit rate.</p> <p>CREATOR: Indicates the creator.</p> <p>SHOOTER: Indicates the shooter.</p> <p>PLACE NAME: Indicates the shooting place.</p> <p>PROGRAM NAME: Indicates the program name.</p> <p>SCENE NO.: Indicates the scene number.</p> <p>TAKE NO.: Indicates the take number.</p> <p>REPORTER: Indicates the reporter.</p> <p>PURPOSE: Indicates the purpose.</p> <p>OBJECT: Indicates the object.</p> <p>START UB: Indicates the start user bit.</p> <p>REC RATE: Indicates the recording frame rate.</p> <p>LAST UP DATE: Indicates the last update date.</p> <p>LAST UP PERSON: Indicates the last person who updated the clip.</p> <p>MANUFACTURER: Indicates the name of the manufacturer.</p> <p>SERIAL NO.: Indicates the serial number.</p> <p>MODEL NAME: Indicates the model name.</p> <p>ALTITUDE: Indicates the altitude.</p> <p>LONGITUDE: Indicates the longitude.</p> <p>LATITUDE: Indicates the latitude.</p> <p>1ST TEXT MEMO: Indicates the contents of the first text memo.</p> <p>THUMBNAIL OFFSET: Indicates the thumbnail recording position.</p> <p>Note:</p> <ul style="list-style-type: none"> • Up to six items can be displayed simultaneously. • When the sixth item has been selected, no other unchecked item can be selected. • Clearing the check mark from a checked item allows you to select another item. | <p>59.94Hz 50Hz</p> |
| INFORMATION SEL. | <p>Selects whether thumbnail information (such as the number of selected clips, the clip playback time and so on) or the bonding device information will be displayed.</p> <p>THUMBNAIL INFO.: Displays thumbnail information, such as the number of selected clips and the clip playback time.</p> <p>BONDING DEV. INFO.: Displays the information for the bonding device.</p> | <p>59.94Hz 50Hz</p> |
| THUMBNAIL INFO. | <p>Sets the item that displays the number of selected clips or the clip playback durations.</p> <p>NUM. OF CLIPS: Displays the number of selected clips.</p> <p>DUR. OF SEL CLIPS: Displays the total playback duration of the selected clips.</p> <p>TOTAL DURATION: Displays the total playback duration of the displayed clips.</p> | <p>59.94Hz 50Hz</p> |
| TEXT MEMO IND | <p>Sets the display mode of the text memo indicator displayed for clips on the thumbnail screen.</p> <p>ALL: Displays the indicator for all clips with text memos attached.</p> <p>HIDE CARD SERIAL: Hides the text memo indicator for clips with only the following types of text memos attached.</p> <ul style="list-style-type: none"> • Text memo with the serial number of card written: • Other text memos for which offset is not set with clip metadata: <p>To record a text memo with the serial number of card written as metadata, set the menu "CARD SERIAL" (→ page 101) to "ON".</p> <p>Check "OFFSET" of "MEMO" on the clip properties screen to see whether offset is set for a text memo.</p> | <p>59.94Hz 50Hz</p> |

STORAGE COPY SETUP

CLIP > STORAGE COPY SETUP



_ is the factory default setting.

| Item | Settings and brief function description | FREQ indications |
|--------|---|----------------------------|
| VERIFY | Sets whether to perform verification during exporting. ON: Performs verification. OFF: Does not perform verification. Note: This is enabled only for TYPE S formatted storage devices. | 59.94Hz 50Hz |

REC/PB FUNCTION

REC/PB > REC/PB FUNCTION

_ is the factory default setting.

| Item | Settings and brief function description | FREQ indications |
|-------------|--|----------------------------|
| RECORDING | Selects the recording method. NORMAL : Normal recording LOOP : Loop recording | 59.94Hz 50Hz |
| AUTO REC | Selects whether recording and stopping are performed automatically in accordance with the record and stop signals of the HD SDI*1 and HDMI input signals from a camera-recorder. TYPE1 : Recording and stopping is performed automatically in accordance with the record and stop signals in the LTC information attached to HD SDI signals. TYPE2 : Recording and stopping is performed automatically in accordance with the record and stop signals in the SVITC information attached to HD SDI signals. TYPE3 : Set this when using other manufacturer's camera-recorders. TYPE4 : Recording and stopping are performed automatically in accordance with the record and stop signals added to HDMI. OFF : Recording and stopping is not performed automatically. Note : <ul style="list-style-type: none"> • SD SDI signals are not supported. • When this is set to other than OFF and the status becomes REC PAUSE, "AREC" is displayed in a superimposed screen. • To start automatic recording, press the [REC]  and [PAUSE]  buttons simultaneously to switch the unit to the REC PAUSE state. This function does not work in any state other than REC PAUSE. Also, the unit switches to the REC PAUSE state after an automatic stop. • For the details on devices for which compatibility has been verified, visit the website. (→ "Website URL" page 9) • In normal recording mode, this setting is not available and an automatic stop is not performed. | 59.94Hz 50Hz |
| REPEAT PLAY | Sets whether to perform repeat playback during playback. ON : Performs repeat playback. After the last clip is played, playback continues from the beginning clip. OFF : Does not perform repeat playback. Stops playback at the end of the last clip. Note : <ul style="list-style-type: none"> • Repeat playback is not available during TEXT MEMO playback. • If a P2 card is removed during repeat playback, playback is stopped when a clip that no longer exists is reached. • Even if you insert a P2 card during repeat playback, the additional clips will not be played back until you stop repeat playback and then start repeat playback again. | 59.94Hz 50Hz |
| SIMUL REC | Sets whether to record simultaneously to two P2 cards in two microP2 card slots. ON : Performs simultaneous recording. OFF : Simultaneous recording is not performed. | 59.94Hz 50Hz |
| CONT. REC | Sets whether to continue or stop recording when the input signal is disrupted. ON : Continues recording OFF : Pauses recording. | 59.94Hz 50Hz |

*1 3G-SDI LEVEL-A, 3G-SDI LEVEL-B DL, and 1.5G-SDI signals are written as "HD SDI" signals.

REC/PB SETUP

REC/PB > REC/PB SETUP

_ is the factory default setting.

| Item | Settings and brief function description | FREQ indications |
|--------------|---|----------------------------|
| REC MEDIA | <p>Selects the slots for recording.</p> <p>microP2: Uses the microP2 memory card slots (card slots 1 and 2).</p> <p>P2: Uses the P2 memory card slot (card slot 3).</p> <p>Note: Recording is not possible for a slot that is not selected but playback is possible. The slot indication is the same as that of a card for which recording is prohibited.</p> | 59.94Hz 50Hz |
| FILE SPLIT | <p>Selects whether to split the recording file every 4 GB or record one file when recording to a microP2 memory card (over 32 GB) in the AVC-LongG format.</p> <p>ONE FILE: Records to one file.</p> <p>SPLIT: Splits the clip every 4 GB.</p> <p>SHORT SPLIT: The clip is split every 128 seconds regardless of the recording format.</p> <p>Note: If you select "ONE FILE," that clip will not be able to be copied to a P2 memory card or a 32 GB microP2 memory card or copied or exported to a storage device. Also, "ONE FILE" cannot be selected when an option other than "OFF" is set in the menu "CODEC USAGE" (→ page 99). When "SHORT SPLIT" is selected, the clip is split into recording files of approximately 128 seconds each, but is handled as a single clip when the thumbnail is operated on the P2 device. The duration of one continuous recording is approximately 3.5 hours. After approximately 3.5 hours pass, recording stops and "REC WARNING" appears. "SHORT SPLIT" is disabled during loop recording.</p> | 59.94Hz 50Hz |
| CC REC | <p>Selects whether to record a closed caption signal superimposed on the SD SDI input signal.</p> <p>ON: Records a closed caption signal superimposed on an input signal.</p> <p>OFF: Does not record a closed caption signal. The EE output is also blanked.</p> | 59.94Hz |
| CC(F1) BLANK | <p>Turns on or off closed caption signals in the first field output from the SD SDI during playback.</p> <p>BLANK: Forcibly blanks signals.</p> <p>THROUGH: Does not blank signals.</p> | 59.94Hz |
| CC(F2) BLANK | <p>Turns on or off closed caption signals in the second field output from the SD SDI during playback.</p> <p>BLANK: Forcibly blanks signals.</p> <p>THROUGH: Does not blank signals.</p> | 59.94Hz |
| SHUTTLE MAX | <p>Sets the maximum speed for the shuttle operation.</p> <p>X8: 8 x normal speed</p> <p>X16: 16 x normal speed</p> <p>X32: 32 x normal speed</p> <p>X60: 60 x normal speed</p> <p>X100: 100 x normal speed</p> | 59.94Hz 50Hz |
| FF.REW MAX | <p>Sets the maximum speed for the FF and REW operation.</p> <p>X32: 32 x normal speed</p> <p>X60: 60 x normal speed</p> <p>X100: 100 x normal speed</p> <p>SEEK: Seeks (moves to) the beginning of the clip</p> | 59.94Hz 50Hz |
| SEEK POS SEL | <p>Sets the positions to which to move with the seek (movement) operations performed by pressing the [NEXT] button and [PREV] button.</p> <p>CLIP: Beginning of the clip</p> <p>CLIP&TEXT MEMO: Beginning of the clip or the setting point of a text memo</p> | 59.94Hz 50Hz |

DUAL CODEC SETUP

REC/PB > DUAL CODEC SETUP

◆ Note:

When a setting other than "NORMAL" is selected in the "RECORDING" setting menu item (→ page 97), or when "ON" is selected in the "SIMUL REC" item (→ page 97), proxy recording cannot be performed even if "CODEC USAGE" is set to "PROXY REC(P2)" or "PROXY REC(P2&SD)."

_ is the factory default setting.

| Item | Settings and brief function description | FREQ indications |
|-------------------|--|----------------------------|
| CODEC USAGE | Selects the media for proxy data recording. PROXY REC (P2) : Records proxy data to a P2 card. PROXY REC (P2&SD) : Records proxy data to both a P2 card and SD memory card. STREAMING : Outputs streaming data. OFF : Proxy data recording and streaming output are not performed. If CODEC USAGE cannot be changed, change the PROXY REC MODE or STREAMING MODE setting. | 59.94Hz 50Hz |
| PROXY REC MODE | Sets the recording mode for proxy data. LOW 2CH MOV (Only in 1080i mode) <u>HQ 2CH MOV</u> SHQ 2CH MOV AVC-G6 2CH MOV For details on each mode, refer to "Recording modes and recording signals (video and audio)" (→ page 33). | 59.94Hz 50Hz |
| STREAMING MODE | Sets the streaming transfer mode. LOW <u>HQ</u> AVC-G6 SHQ(QoS) AVC-G(QoS) | 59.94Hz 50Hz |
| QoS MAX RATE | Sets the maximum bitrate for video data when the QoS is operating. This setting is used when the streaming distribution is started from the operation of the unit. This can be set when the menu "START TRIGGER" (→ page 106) is set to "AJ-PG50". 256Kbps 512Kbps 1Mbps 1.5Mbps 2.5Mbps 3.5Mbps 6Mbps <u>9Mbps</u> "9Mbps" cannot be selected when "STREAMING MODE" is set to "SHQ (QoS)". | 59.94Hz 50Hz |
| QoS MIN RATE | Sets the minimum bitrate for video data when the QoS is operating. This setting is used when the streaming distribution is started from the operation of the unit. This can be set when the menu "START TRIGGER" (→ page 106) is set to "AJ-PG50". <u>256Kbps</u> 512Kbps 1Mbps 1.5Mbps 2.5Mbps 3.5Mbps 6Mbps 9Mbps | 59.94Hz 50Hz |
| STREAMING LATENCY | Sets the delay mode during the streaming distribution. This setting is used when the streaming distribution is started from the operation of the unit. This can be set when the menu "START TRIGGER" (→ page 106) is set to "AJ-PG50". <u>NORMAL</u> : Set if you want to emphasize the stability of streaming. SHORT : Set if you want to emphasize the reduction of streaming delay. | 59.94Hz 50Hz |

| Item | Settings and brief function description | FREQ indications |
|-------------|---|----------------------------|
| CTL DISPLAY | Selects the 12- or 24-hour format for the CTL counter display. ±12h: 12-hour format display 24h: 24-hour format display | 59.94Hz 50Hz |
| TCG MODE | Sets the operating mode of the internal time code generator. REGEN: Synchronizes the internal time code generator to maintain continuity with the last time code recorded on the P2 card. PRESET: Starts recording from the value set with the [TC PRESET] button. EXT: Uses the external time code input from the TIME CODE IN connector or VITC or SLTC of the video signal. Set the selection in the "EXT TC SEL" (→ page 100) menu item. | 59.94Hz 50Hz |
| UBG MODE | Sets the operating mode for the user bits of the internal time code generator. REGEN: Synchronizes the internal time code generator with the last user bit recorded on a P2 card. PRESET: Starts recording from the value set with the [TC PRESET] button. EXT: Uses the external UB input from the TIME CODE IN connector or VITC or SLTC of the video signal. Set the selection in the "EXT TC SEL" (→ page 100) menu item. | 59.94Hz 50Hz |
| RUN MODE | Sets the operating mode for advancing the internal time code generator. REC RUN: Advances the internal time code generator only during recording. FREE RUN: Advances the internal time code generator while the power is on regardless of the operating mode. | 59.94Hz 50Hz |
| EXT TC SEL | Sets the time code to use when an external time code is used. EXT LTC: LTC of TIME CODE IN connector. S/H LTC: LTC information added to the signals input to the SDI IN connector or HDMI IN connector. S/H VITC: VITC information added to the signals input to the SDI IN connector or HDMI IN connector. Note: When "S/H LTC" or "S/H VITC" is set and "SD SDI" is selected as the input video signal, the VITC of the input video signal is used. | 59.94Hz 50Hz |
| VITC GEN | Sets whether to record the internal time code generator value in the VAUX area. ON: Records the internal time code generator value. OFF: Does not record the internal time code generator value. When the VITC information is superimposed on the input video signal, that value is recorded. Note: When the "LINE&FREQ" menu item is set to "720-59.94P" or "720-50P," the operation is as follows. <ul style="list-style-type: none"> Time code data recorded in the VAUX area: Even if this menu item is set to OFF, the internal time code generator value is recorded when VITC information is not superimposed on the input video signal User bit data recorded in the VAUX area: The frame rate information is always recorded regardless of the setting of this menu item. | 59.94Hz 50Hz |
| DF MODE | Sets the drop frame mode or non-drop frame mode for CTL and TCG. DE: Uses drop frame mode. NDF: Uses non-drop frame mode. | 59.94Hz |
| VITC BLANK | Selects whether to output VITC signals at the positions specified in the "VITC POS-1" and "VITC POS-2" menu items during playback. BLANK: Does not output a VITC signal. THROUGH: Outputs VITC signals. Note: <ul style="list-style-type: none"> This setting is enabled only during SD SDI output. In EE mode, the VITC signal superimposed on the input signal is output as is. | 59.94Hz 50Hz |

| Item | Settings and brief function description | FREQ indications |
|--------------|--|----------------------------|
| VITC POS-1 | Sets the position to insert the VITC signal. <ul style="list-style-type: none"> When set to 59.94 Hz: LINE 10 to <u>LINE 16</u> to LINE 20 When set to 50 Hz: LINE 7 to <u>LINE 11</u> to LINE 22 Note: <ul style="list-style-type: none"> The same line as the "VITC POS-2" menu item cannot be selected. This setting is enabled only during SD SDI output. Pressing the [RESET] button will not restore the factory defaults. | 59.94Hz 50Hz |
| VITC POS-2 | Sets the position to insert the VITC signal. <ul style="list-style-type: none"> When set to 59.94 Hz: LINE 10 to <u>LINE 18</u> to LINE 20 When set to 50 Hz: LINE 7 to <u>LINE 13</u> to LINE 22 Note: <ul style="list-style-type: none"> The same line as the "VITC POS-1" menu item cannot be selected. This setting is enabled only during SD SDI output. Pressing the [RESET] button will not restore the factory defaults. | 59.94Hz 50Hz |
| HD EMBD LTC | Selects whether to superimpose the LTC information on HD SDI output. ON: Superimposes LTC. OFF: Does not superimpose LTC. | 59.94Hz 50Hz |
| HD EMBD VITC | Selects whether to superimpose the VITC information on HD SDI output. ON: Superimposes VITC. OFF: Does not superimpose VITC. | 59.94Hz 50Hz |

REC META DATA

_ is the factory default setting.

| Item | Settings and brief function description | FREQ indications |
|----------------|--|----------------------------|
| LOAD | Loads a metadata upload file stored on an SD memory card. | 59.94Hz 50Hz |
| RECORD | Sets whether to add the loaded metadata during recording. ON: Adds the metadata. OFF: Does not add the metadata. | 59.94Hz 50Hz |
| CARD SERIAL | Enables/disables the function for storing the text memo with the serial number or the type of card as metadata. ON: Records. OFF: Does not record. | 59.94Hz 50Hz |
| USER CLIP NAME | Sets the data to be recorded to USER CLIP NAME. <ul style="list-style-type: none"> When "RECORD" is "ON" <ul style="list-style-type: none"> TYPE1: Records the loaded data setting values. TYPE2: Records the loaded data and counter values. When "RECORD" is "OFF" <ul style="list-style-type: none"> TYPE1: Records the same values as GLOBAL CLIP ID. TYPE2: Records the same values as CLIP NAME. | 59.94Hz 50Hz |
| INITIALIZE | Deletes and initializes all the loaded metadata. | 59.94Hz 50Hz |
| PROPERTY | Allows you to check and edit the loaded metadata. | 59.94Hz 50Hz |

I/F SETUP

CLOCK

I/F SETUP > CLOCK

For details, refer to “Setting the Year, Month, Day, and Time” (→ page 25).

BASIC

I/F SETUP > BASIC

_ is the factory default setting.

| Item | Settings and brief function description | FREQ indications |
|----------------|---|----------------------------|
| BEEP | Turns the beep sound on or off. ON : Outputs a beep sound. OFF : Does not output a beep sound. Note: A beep sound is also output from the [PHONES] jack. | 59.94Hz 50Hz |
| KEYBOARD | Sets the type of keyboard to be connected. QWERTY(101) QWERTY(109) AZERTY QWERTZ | 59.94Hz 50Hz |
| POWER ON GUI | Sets whether to display the thumbnail screen at power-on. THUMBNAIL : Displays the thumbnail screen. OFF : Does not display the thumbnail screen. | 59.94Hz 50Hz |
| AUTO POWER OFF | Sets the button operation inactivity period after which to turn off the power automatically. 10min : Turns off the power after 10 minutes of inactivity. 30min : Turns off the power after 30 minutes of inactivity. 60min : Turns off the power after 60 minutes of inactivity. 90min : Turns off the power after 90 minutes of inactivity. OFF : Does not turn off the power of the unit and maintains the energized state. Note: <ul style="list-style-type: none">• Even when this setting is other than OFF, the power is not turned off during playback (including variable speed playback, fast forward/fast rewind, and pause) and recording.• When the unit is connected to an external device with a USB cable and is in the energized state or when the unit is in PLAYLIST mode, the power is not turned off even if the above button activity does not occur.• Set this to “OFF” when streaming video. If you set a time, the power will turn off due to inactivity. | 59.94Hz 50Hz |

VIDEO

I/F SETUP > VIDEO

_ is the factory default setting.

| Item | Settings and brief function description | FREQ indications |
|-----------------|---|----------------------------|
| INPUT SEL | <p>Selects the video input signal.</p> <p>HD SDI: Selects the SDI connector (HD signal input).</p> <p>SD-SDI: Selects the SDI connector (SD signal input).</p> <p>HDMI: Selects the HDMI IN connector.</p> <p>INT SG: Selects the internal signal generator. The signal switches to the internal signal selected in the INT SG menu item.</p> <p>Note</p> <ul style="list-style-type: none"> • This unit does not support 60 Hz JUST frequency signals. For the input signals, use 59.94 Hz or 50 Hz signals. • The unit can only receive the signal format configured in the "LINE&FREQ" setting, so be sure that the format of the input signal matches that setting. • When an input signal cannot be received, the "INVALID INPUT FORMAT" warning will be displayed and the video will be black and muted. • The HD SDI / SD SDI item is displayed in accordance with the "LINE&FREQ" setting. | 59.94Hz 50Hz |
| INT SG | <p>Sets the internal signal type. SMPTE and ARIB signals are enabled only when the "LINE&FREQ" setting is set to the HD format (black in SD mode).</p> <p>100%CB: 100% color bar</p> <p>75%CB: 75% color bar</p> <p>SMPTE: SMPTE color bar</p> <p>ARIB: ARIB color bar</p> <p>BLACK: Black</p> | 59.94Hz 50Hz |
| SG MOVE | <p>Switches to the function for displaying a square that automatically changes its position on the INT SG.</p> <p>ON: Displays.</p> <p>OFF: Does not display.</p> | 59.94Hz 50Hz |
| WIDE SEL | <p>Sets whether to record the WIDE information when "LINE&FREQ" is set to "480-59.94i" or "576-50i."</p> <p>WIDE: Records the information.</p> <p>NORMAL: Does not record the information.</p> | 59.94Hz 50Hz |
| EDH(SD) | <p>Selects whether to superimpose EDH on SD SDI output signals.</p> <p>ON: Superimposes EDH.</p> <p>OFF: Does not superimpose EDH.</p> | 59.94Hz 50Hz |
| OUTPUT FORMAT | <p>Selects the video signal output from the video output connector.</p> <p>AUTO: Switches output automatically in accordance with the current recording and playback format.</p> <ul style="list-style-type: none"> • When 59.94 Hz is set 1080P: 1080/59.94p 720P: 720/59.94p 1080i: 1080/59.94i 480i: 480/59.94i • When 50 Hz is set 1080P: 1080/50p 720P: 720/50p 1080i: 1080/50i 576i: 576/50i <p>Note:</p> <ul style="list-style-type: none"> • When other than "AUTO" is selected, a signal that differs from the recording and playback format is automatically converted before output. • This is not displayed when "LINE&FREQ" is set to "480-59.94i" or "576-50i." | 59.94Hz 50Hz |
| HDMI OUT FORMAT | <p>Switches HDMI output to interlaced signals or progressive signals when "LINE&FREQ" is "480-59.94i" or "576-50i," or "OUTPUT FORMAT" is "480i" or "576i."</p> <ul style="list-style-type: none"> • When 59.94 Hz is set 480i: Outputs as interlaced signals (480/59.94i). 480P: Outputs as progressive signals (480/59.94p). • When 50 Hz is set 576i: Outputs as interlaced signals (576/50i). 576P: Outputs as progressive signals (576/50p). | 59.94Hz 50Hz |

I/F SETUP > VIDEO (Continued)

| Item | Settings and brief function description | FREQ indications |
|--------------|---|----------------------------|
| 3G-SDI OUT | Selects the 3G-SDI output format for when "LINE&FREQ" (→ page 114) is "1080-59.94P" or "1080-50P." LEVEL-A: Selects the 3G-SDI LEVEL-A format. LEVEL-B: Selects the 3G-SDI LEVEL-B DL format. | 59.94Hz 50Hz |
| DOWNCON MODE | Selects the aspect ratio for down-conversion output. FIT-V: Changes the ratio to match the input size to the output size along the vertical axis. (The aspect ratio is maintained.) FIT-H: Changes the ratio to match the input size to the output size along the horizontal axis. (The aspect ratio is maintained.) FIT-HV: Changes the ratio to match the input size to the output size along the horizontal and vertical axes. (The aspect ratio may be distorted.) | 59.94Hz 50Hz |

AUDIO

I/F SETUP > AUDIO

_ is the factory default setting.

| Item | Settings and brief function description | FREQ indications |
|-----------------|---|----------------------------|
| INPUT SEL | Selects the audio input signal. V IN SEL: Selects the same signal as the VIDEO input signal selection. ANALOG: Selects the ANALOG AUDIO IN connector. | 59.94Hz 50Hz |
| INPUT CH1 LEVEL | Selects the level for the CH1 analog audio input. 4 dB <u>0 dB</u> -3 dB -20 dB | 59.94Hz 50Hz |
| INPUT CH2 LEVEL | Selects the level for the CH2 analog audio input. 4 dB <u>0 dB</u> -3 dB -20 dB | 59.94Hz 50Hz |
| MONITOR CH | Sets the audio to output to the monitor outputs. Select the outputs for L and R. HDMI output audio is also in accordance with this setting. CH1 / 2: Outputs CH1 to L and CH2 to R. CH3 / 4: Outputs CH3 to L and CH4 to R. CH1 + 2 / 3 + 4: Outputs CH1+2 to L and CH3+4 to R. CH1 + 3 / 2 + 4: Outputs CH1+3 to L and CH2+4 to R. | 59.94Hz 50Hz |
| SPEAKER OUT | Turns on/off speaker output. ON: Outputs from the speakers. OFF: Does not output from the speakers. (Beep sounds are also not output.) | 59.94Hz 50Hz |
| REF LEVEL | Selects the standard level. FS-20: -20 dB FS-18: -18 dB FS-12: -12 dB | 59.94Hz 50Hz |

NETWORK

I/F SETUP > NETWORK

_ is the factory default setting.

| Item | Settings and brief function description | FREQ indications |
|--------------------|---|----------------------------|
| NETWORK SEL | Selects network connection method. WLAN: Connects via a wireless LAN. 4G/LTE: Connects via 3G/4G/LTE. LAN: Connects via the LAN connector on the unit. OFF: Does not use the network. Note: For details on a network connection, refer to "Network Connection" (→ page 65). | 59.94Hz 50Hz |
| NETWORK FUNC | | |
| HTTP SERVER | Sets the HTTP server function. BROWSE: Enables the P2 Browser function. BROWSE (+CTRL): Enables the HTTP server function, starting and stopping recording from a terminal, and time code and user bit preset control. DISABLE: Disables the HTTP server function. | 59.94Hz 50Hz |
| USER ACCOUNT | Sets the user account name. | 59.94Hz 50Hz |
| ACCOUNT LIST | Displays the set account names. Also allows you to register a new account, delete an account, or change a password. | 59.94Hz 50Hz |
| FTP CLIENT SERVICE | | |
| SETTING DATA | Sets from where client service settings are acquired. INTERNAL: Uses the settings set on the unit. SD CARD: Uses the settings of the file inside the SD memory card inserted in the SD card slot. When this item is set to "SD CARD", insert an SD memory card before turning on the power of the unit. | 59.94Hz 50Hz |
| SERVER URL | Sets the name or address of the connection destination server. | 59.94Hz 50Hz |
| LOGIN USER | Sets the user ID for the connection. | 59.94Hz 50Hz |
| LOGIN PASSWORD | Sets the password for the connection. | 59.94Hz 50Hz |
| SSH | Set this for transferring files using SSH. ENABLE: Uses SSH. DISABLE: Does not use SSH. | 59.94Hz 50Hz |
| SSH PORT | Sets the network port number for using SSH. Set this to the same number as on the server side. Initial setting: <u>22</u> The setting value is not displayed due to security purposes. | 59.94Hz 50Hz |
| LOAD (SD CARD) | Loads the settings of the client service from the SD memory card. | 59.94Hz 50Hz |
| SAVE (SD CARD) | Saves the settings of the client service onto the SD memory card. | 59.94Hz 50Hz |
| REC DURING UPLOAD | Sets the rec during upload function. ENABLE: Uses the rec during upload function. DISABLE: Does not use the rec during upload function. | 59.94Hz 50Hz |
| AUTO UPLOAD | Sets whether to enable the function to register clips recorded using the unit automatically to the upload list when recording stops, and if enabled, sets the type of target clip. REC CLIP (PROXY): Upload target is proxy data of recorded clips. REC CLIP: Upload target is recorded clips (main recording data and proxy data). DISABLE: Recorded clips are not upload targets. | 59.94Hz 50Hz |
| UPLOAD LIST | Displays the list information of clips to upload. | 59.94Hz 50Hz |
| SAVE LOG (SD CARD) | Save up to the latest 1000 logs for clip information (month and date, clip number (global clip ID), status) registered in the upload list to an SD memory card. | 59.94Hz 50Hz |

I/F SETUP > NETWORK (Continued)

| Item | Settings and brief function description | FREQ indications |
|-------------------|--|----------------------------|
| STREAMING SETTING | | |
| START TRIGGER | Sets the method for starting video streaming. AJ-PG50: Starts/stops streaming from the unit. RECEIVER: Operates the start/stop of the streaming distribution from the terminal on the network using the P2 Browser or the P2 Streaming Receiver. | 59.94Hz 50Hz |
| SETTING DATA | Sets the source from where settings for streaming is acquired when "AJ-PG50" is selected in "START TRIGGER". INTERNAL: Uses the settings set on the unit. SD CARD: Uses the settings of the file inside the SD memory card inserted in the SD card slot. When this item is set to "SD CARD", insert an SD memory card before turning on the power of the unit. | 59.94Hz 50Hz |
| SERVER ADDR. | Sets the IP address of the device receiving the streaming video when "AJ-PG50" is selected in "START TRIGGER". | 59.94Hz 50Hz |
| RTSP PORT | Sets the RTSP port number required for streaming when "AJ-PG50" is selected in "START TRIGGER". Factory default setting: 554 | 59.94Hz 50Hz |
| LOAD (SD CARD) | When "AJ-PG50" is selected in "START TRIGGER" and "INTERNAL" is selected in "SETTING DATA", the connection information necessary for streaming distribution is read from the SD memory card. | 59.94Hz 50Hz |
| SAVE (SD CARD) | When "AJ-PG50" is selected in "START TRIGGER" and "INTERNAL" is selected in "SETTING DATA", the connection information necessary for streaming distribution is saved to the SD memory card. | 59.94Hz 50Hz |
| STREAMING | When "AJ-PG50" is selected in "START TRIGGER", the streaming distribution is started/ stopped from the unit. START: Starts streaming. STOP: Stops streaming. | 59.94Hz 50Hz |
| LAN PROPERTY | | |
| MAC ADDRESS | Displays the MAC address of the LAN connector of the unit. (This cannot be changed.) | 59.94Hz 50Hz |
| DHCP | Automatically sets the network settings by DHCP. ENABLE: Uses DHCP (automatic assignment) DISABLE: Enter the settings without using DHCP (automatic assignment). When "DISABLE" is selected, the following menu items are displayed. Set the items. IP ADDRESS: Sets the IP address. SUBNET MASK: Sets the subnet mask. DEFAULT GATEWAY: Sets the default gateway address. PRIMARY DNS: Sets the address of the primary DNS server. SECONDARY DNS: Sets the address of the secondary DNS server. DHCP SERVER: Sets whether to use the DHCP SERVER function when connecting via a wired LAN. | 59.94Hz 50Hz |
| WIRELESS PROPERTY | | |
| MAC ADDRESS | Displays the MAC address of the wireless LAN of the unit. (This cannot be changed.) | 59.94Hz 50Hz |
| TYPE | Selects the connection method. DIRECT: Enables direct access to the network functions of the unit from a smartphone, tablet, or computer. INFRA: Connects with a wireless access point. | 59.94Hz 50Hz |
| SSID INPUT MODE | Sets the SSID setting method. SELECT: Select from an access point list. MANUAL: Enter manually | 59.94Hz 50Hz |
| SSID | Displays the network name (SSID). | 59.94Hz 50Hz |
| BAND | Switches between two transmission methods (2.4 GHz or 5 GHz). 2.4GHz 5GHz | 59.94Hz 50Hz |

I/F SETUP > NETWORK (Continued)

| Item | Settings and brief function description | FREQ indications |
|------------------------|--|----------------------------|
| CHANNEL (2.4GHz) | Sets the channel to use when "DIRECT" is selected for "TYPE" and connected via a wireless LAN. AUTO CH1 CH6 CH11 | 59.94Hz 50Hz |
| CHANNEL (5GHz) | Sets the channels to be used when "DIRECT" is selected in "TYPE", "5GHz" is selected in "BAND", and the camera is connected via wireless LAN. The selections change according to the wireless module to mount. AUTO CH36 CH40 CH44 CH48 CH149 CH153 CH157 CH161 CH165 | 59.94Hz 50Hz |
| ENCRYPTION | Sets the encryption method. WPA-TKIP WPA-AES WPA2-TKIP WPA2-AES NONE | 59.94Hz 50Hz |
| ENCRYPT KEY | Sets the encryption key. Set a string of 8 to 63 characters or a 64 digit hexadecimal number. Factory default setting: 01234567890123456789abcdef | 59.94Hz 50Hz |
| DHCP | Sets whether to use automatic assignment by DHCP when "INFRA" is selected for "TYPE" ENABLE : Uses automatic assignment. DISABLE : Does not use automatic assignment. Set "IP ADDRESS," "SUBNET MASK," "DEFAULT GATEWAY," "PRIMARY DNS," and "SECONDARY DNS." | 59.94Hz 50Hz |
| IP ADDRESS | Set the IP address when "DISABLE" is selected for "DHCP." Factory default setting: 192.168.0.1 | 59.94Hz 50Hz |
| SUBNET MASK | Set the subnet mask when "DISABLE" is selected for "DHCP." Factory default setting: 255.255.255.0 | 59.94Hz 50Hz |
| DEFAULT GATEWAY | Set the default gateway when "INFRA" is selected for "TYPE" and "DISABLE" is selected for "DHCP." Factory default setting: 192.168.0.254 | 59.94Hz 50Hz |
| PRIMARY DNS | Set the primary DNS server when "INFRA" is selected for "TYPE" and "DISABLE" is selected for "DHCP" or when "ENABLE" is selected for "DHCP" and the primary DNS server cannot be obtained. Factory default setting: 0.0.0.0 | 59.94Hz 50Hz |
| SECONDARY DNS | Set the alternate DNS server when "INFRA" is selected for "TYPE" and "DISABLE" is selected for "DHCP" or when "ENABLE" is selected for "DHCP" and the primary DNS server cannot be obtained. Factory default setting: 0.0.0.0 | 59.94Hz 50Hz |
| DHCP SERVER | Sets whether to use the DHCP SERVER function when "DIRECT" is selected for "TYPE" and connected via a wireless LAN. ENABLE : Use the DHCP SERVER function. DISABLE : Do not use the DHCP SERVER function. | 59.94Hz 50Hz |
| 4G/LTE PROPERTY | | |
| APN | Set the APN (access point name) provided from the provider. | 59.94Hz 50Hz |
| USER ID | Set the user name provided from the provider. | 59.94Hz 50Hz |
| PASSWORD | Set the password provided from the provider. | 59.94Hz 50Hz |
| DIAL NO. | Sets the phone number. For details, refer to instructions provided by the provider to which you are subscribed. | 59.94Hz 50Hz |

I/F SETUP > NETWORK (Continued)

| Item | Settings and brief function description | FREQ indications |
|----------------|---|----------------------------|
| NETWORK TOOLS | | |
| LOG DISPLAY | Displays the connection log. | 59.94Hz 50Hz |
| STATUS DISPLAY | Displays the network status. | 59.94Hz 50Hz |
| INITIALIZE | Initializes various network settings to restore them to the factory defaults. | 59.94Hz 50Hz |
| PING | Checks the network connection. | 59.94Hz 50Hz |

DISPLAY

I/F SETUP > DISPLAY

_ is the factory default setting.

| Item | Settings and brief function description | FREQ indications |
|---------------|--|----------------------------|
| GUI OUTPUT | Set whether to output the thumbnail screen to HDMI OUT and SDI OUT. LCD: Not output (displayed only on LCD monitor) ALL: Outputs to all of the LCD, HDMI OUT, and SDI OUT. | 59.94Hz 50Hz |
| OSD OUTPUT | Set whether to output the superimposed display to HDMI OUT and SDI OUT. LCD: Does not output (displayed only on the LCD monitor). ALL: Outputs to all of the LCD, HDMI OUT, and SDI OUT. | 59.94Hz 50Hz |
| OSD GRADE | Sets superimposed display for the recording or playback screen. ALL: Displays all. NO LVL METER: Does not display the audio level meter. | 59.94Hz 50Hz |
| OSD TC SELECT | Sets the superimposed display items. Here, data indicates the CTL/TC/UB value selected with the [COUNTER] button. TIME: Data T&STATUS: Data and operating status T&S&M: Data, operating status, clip number, video format, audio bit rate T&REC TIME: Data and REC TIME T&REC DATE: Data and REC DATE T&UB: Data and user bits However, when UB is selected with the [COUNTER] button, the time code is indicated after the user bits. T&CTL: Data and CTL However, when CTL is selected with the [COUNTER] button, the time code is indicated after the CTL data. T&T: Data and time code Note: When "T&S&M" is set, an error message appears in the superimposed display if a warning or error occurs. | 59.94Hz 50Hz |
| WFM TYPE | Selects waveform and vector monitor display. WAVE: Waveform display VECTOR: Vector display OFF: Does not display. | 59.94Hz 50Hz |
| WFM POSI | Selects the display position for the waveform monitor. R/T: Positioned at top right. L/T: Positioned at top left. R/B: Positioned at bottom right. L/B: Positioned at bottom left. Note: The display on the LCD monitor moves left or right only. | 59.94Hz 50Hz |
| 4:3 MARKER | Sets whether to display the 4:3 marker on the LCD monitor. ON: Displays. OFF: Does not display. | 59.94Hz 50Hz |
| CHARA V POSI | Sets the vertical text position for superimposed display. TOP: Display at the top of the screen. BOTTOM: Display at the bottom of the screen. | 59.94Hz 50Hz |

LCD MONITOR

I/F SETUP > LCD MONITOR

_ is the factory default setting.

| Item | Settings and brief function description | FREQ indications |
|-------------|---|----------------------------|
| TIME OUT | Turns off the backlight of the LCD monitor automatically if a set time (approximately 5 minutes) elapses after any operation is performed. 5min: Turns off the backlight of the LCD monitor automatically after approximately 5 minutes. OFF: Does not turn off the backlight of the LCD monitor. | 59.94Hz 50Hz |
| BACKLIGHT | Adjusts the brightness of the LCD monitor backlight. -3: Darkest to 0: Normal brightness 1: Brighter than normal | 59.94Hz 50Hz |
| BRIGHTNESS | Adjusts the brightness of the LCD monitor. -15 to 0 to 15 | 59.94Hz 50Hz |
| COLOR LEVEL | Adjusts the color level of the LCD monitor. -15 to 0 to 15 | 59.94Hz 50Hz |
| CONTRAST | Adjusts contrast of the LCD monitor. -30 to 0 to 30 Note: This value multiplied by the R, G, and B contrast setting becomes the contrast adjustment value for R, G, and B. | 59.94Hz 50Hz |
| R CONTRAST | Adjusts the R (Red) contrast of the LCD monitor. -30 to 0 to 30 Note: This setting multiplied by the "CONTRAST" setting becomes the contrast setting. | 59.94Hz 50Hz |
| G CONTRAST | Adjusts the G (Green) contrast of the LCD monitor. -30 to 0 to 30 Note: This setting multiplied by the "CONTRAST" setting becomes the contrast setting. | 59.94Hz 50Hz |
| B CONTRAST | Adjusts the B (Blue) contrast of the LCD monitor. -30 to 0 to 30 Note: This setting multiplied by the "CONTRAST" setting becomes the contrast setting. | 59.94Hz 50Hz |
| LCD REVERSE | Sets the function for reversing the top and bottom and the left and right of the display of the LCD monitor. NORMAL: Normal display REVERSE: Displays the top and bottom and the left and right reversed. Note: When REVERSE is set, the top and bottom and the left and right are also reversed for the movement of setting menus and the movement of the cursor in the thumbnail display screen. | 59.94Hz 50Hz |

USER BUTTON

I/F SETUP > USER BUTTON

You can assign specific functions set in menus to the [USER1] to [USER6] buttons.

The settings are stored internally and retained even when the unit is turned off and on. The assigned functions and settings can be confirmed in the DIAG display.

_ is the factory default setting.

| Item | Settings and brief function description | FREQ indications |
|-------|--|-----------------------------------|
| USER1 | <p>TEXT MEMO: Functions as the text memo button.</p> <p>MARKER: Functions as the shot marker ON/OFF button.</p> <p>DELETE: Functions as the "DELETE" shortcut button.</p> <p>FORMAT: Functions as the "FORMAT" shortcut button.</p> <p>COPY: Functions as the "COPY" shortcut button.</p> <p>EXPORT: Functions as the "EXPORT" shortcut button.</p> <p>EXPLORE: Functions as the "EXPLORE" shortcut button.</p> <p>CLIP PROPERTY: Functions as the "CLIP PROPERTY" shortcut button.</p> <p>CARD STATUS: Functions as the "CARD STATUS" shortcut button.</p> <p>1 CLIP PLAY: Functions as the "ONE CLIP PLAY" button.</p> <p>SLOT CLIPS: Switches the thumbnail screen display between "SELECTED CLIPS" → "SLOT1" → "SLOT2" →.</p> <p>SLOT SEL: Changes the P2 card slot for recording.</p> <p>REC MEDIA: Changes the "REC/PB SETUP" - "REC MEDIA" settings.</p> <p>DATA DISPLAY: Changes the "DATA DISPLAY" settings.</p> <p>SEEK POS SEL: Changes the "SEEK POS SEL" settings.</p> <p>CTL DISPLAY: Changes the "CTL DISPLAY" settings.</p> <p>TCG MODE: Changes the "TCG MODE" settings.</p> <p>UBG MODE: Changes the "UBG MODE" settings.</p> <p>RUN MODE: Changes the "RUN MODE" settings.</p> <p>EXT TC SEL: Changes the "EXT TC SEL" settings.</p> <p>VIDEO IN SEL: Changes the "INPUT SEL" (VIDEO) settings.</p> <p>INT SG: Changes the "VIDEO" - "INT SG" settings.</p> <p>AUDIO IN SEL: Changes the "INPUT SEL" (AUDIO) settings.</p> <p>MONITOR CH: Changes the "MONITOR CH" settings.</p> <p>GUI OUTPUT: Changes the "GUI OUTPUT" settings.</p> <p>OSD OUTPUT: Changes the "OSD OUTPUT" settings.</p> <p>OSD GRADE: Changes the "OSD GRADE" settings.</p> <p>WFM TYPE: Changes the "WFM TYPE" settings.</p> <p>REC D.UP: Changes the "REC DURING UPLOAD" settings.</p> <p>UP LIST: Functions as the "UPLOAD LIST" shortcut button.</p> <p>STREAMING: Changes the "STREAMING" settings.</p> <p>LOAD SETUP DATA: Functions as the "SETUP DATA" - "LOAD" shortcut button.</p> <p>NO ASSIGN: A function is not assigned.</p> <p>Note: The same item can be assigned to other [USER] buttons.</p> | <p>59.94Hz 50Hz</p> |
| USER2 | <p>The settings are the same as "USER1". The factory default setting is MONITOR CH.</p> | |
| USER3 | <p>The settings are the same as "USER1". The factory default setting is TEXT MEMO.</p> | |
| USER4 | <p>The settings are the same as "USER1". The factory default setting is REC MEDIA.</p> | |
| USER5 | <p>The settings are the same as "USER1". The factory default setting is SLOT SEL.</p> | |
| USER6 | <p>The settings are the same as "USER1". The factory default setting is MARKER.</p> | |

FILE

The FILE menu is enabled in recording/playback screen mode.
(It is disabled in thumbnail screen mode.)

SETUP DATA (SD CARD)

FILE > SETUP DATA (SD CARD)

| Item | Settings and brief function description | FREQ indications |
|---------|---|----------------------------|
| LOAD | Loads the file selected from the list of setup data files saved to an SD memory card to the unit. | 59.94Hz 50Hz |
| SAVE | Overwrites the file selected in the list of existing files saved to an SD memory card with the current menu settings of the unit. | 59.94Hz 50Hz |
| SAVE AS | Saves the current menu settings of the unit to an SD memory card after a file name and title have been entered. | 59.94Hz 50Hz |

SD CARD PROPERTY

FILE > SD CARD PROPERTY

Displays the SD memory card status.

You can check the format state, amount of free space, and other information.

| | |
|-----------------|--|
| SD STANDARD: | Indicates whether an SD memory card is formatted in compliance with the SD/SDHC/SDXC standard. SUPPORTED: SD/SDHC/SDXC compliant NOT SUPPORTED: Not SD/SDHC/SDXC compliant |
| USED: | Space used [bytes] |
| BLANK: | Space free [bytes] |
| TOTAL: | Total size [bytes] |
| PROXY REM: | Remaining recording space when proxy recording |
| NUMBER OF CLIP: | Number of clips on the SD memory card resulting from copying or proxy recording |
| PROTECT: | Write-protect state |

FORMAT SD CARD

FILE > FORMAT SD CARD

Formats the SD memory card.

LOAD USER DATA

FILE > LOAD USER DATA

Loads a user file saved to the memory of the unit.

INITIALIZE

FILE > INITIALIZE

| Item | Settings and brief function description | FREQ indications |
|-------------------|---|----------------------------|
| LOAD FACTORY DATA | Restores all menu settings to the factory default states. If this is selected, the "SYSTEM RESTART" confirmation message appears. Select "YES" to restart the system automatically. | 59.94Hz 50Hz |
| SAVE USER DATA | Saves the menu settings as user data to the memory of the unit. You can use this for saving unique setup data. To load user data, select "FILE" → "LOAD USER DATA". | 59.94Hz 50Hz |

Saving and loading setup data

You can save set menu items to an SD memory card, and load them to the unit.

There are two operations for saving to an SD memory card: SAVE which allows you to overwrite an existing file and SAVE AS which allows you to create a new file.

◆ Note:

Insert the SD memory card to be used into the SD memory card slot.

■ Overwriting an existing file

- 1 Use the cursor buttons to align the cursor with the "SAVE" (→ page 111) menu item and then press the [SET] button.

A list of the setup data stored in the predetermined folder on the SD memory card is displayed as shown below.

| NO | FILE NAME | TITLE | DATE TIME |
|------|-----------|-----------|----------------------|
| EXIT | | | |
| 1 | upload | Panasonic | 2013-JUL-01 14:45:36 |

- 2 Use the up or down cursor button to move to the file name item for overwriting and then press the [SET] button.

The title input screen and keyboard appear. Enter the characters (up to 8 characters) you want to set from the keyboard. (→ "Using a Keyboard" page 117)

- 3 After entering the title, press the [MENU] button.
- 4 Align the cursor with "YES" in the confirmation message and then press the [SET] button.
Saving of the file begins.
- 5 When the completion message appears, press the [SET] button.

■ Creating a new file

- 1 Use the cursor buttons to align the cursor with the "SAVE AS" (→ page 111) menu item and then press the [SET] button.

The file name and title name input screen and keyboard appear. Enter the file name (up to 8 characters) and title name (up to 12 characters) you want to set from the keyboard. (→ "Using a Keyboard" page 117)

- 2 After entering the file name and title name, use the cursor buttons to select the [OK] button.
- 3 Align the cursor with "YES" in the confirmation message and then press the [SET] button.
Saving of the file begins.
- 4 When the completion message appears, press the [SET] button.

◆ Note:

Setup files saved with the unit cannot be used with other models. Likewise, setup files saved with other models cannot be used with the unit.

■ Loading a setup file

- 1 Use the cursor buttons to align the cursor with the "SETUP DATA (SD CARD)" - "LOAD" (→ page 111) menu item and then press the [SET] button.

A list of the setup files stored in the predetermined folder on the SD memory card is displayed.

- 2 Use the up or down cursor button to move to the file name item for overwriting and then press the [SET] button.
- 3 Align the cursor with "YES" in the confirmation message and then press the [SET] button.
The file loading process begins.
The "SYSTEM RESTART" confirmation message appears. Select "YES" to restart the system automatically.

■ Writing setup data to the user area

- 1 Use the cursor buttons to move the cursor to the “SAVE USER DATA” (→ page 112) menu item and then press the [SET] button.

A confirmation message appears.

- 2 Move the cursor to “YES” in the confirmation message and then press the [SET] button.

The setup data is written to the user area in the memory of the unit.

- 3 When the confirmation message appears, select “OK” and press the [SET] button.

The “SAVE USER DATA” menu item is redisplayed.

■ Loading written user data

- 1 Move the cursor to the “LOAD USER DATA” (→ page 111) menu item and then press the [SET] button.

A confirmation message appears.

- 2 Move the cursor to “YES” in the confirmation message and then press the [SET] button.

The setup data is loaded from the user area in the memory of the unit.

- 3 When the confirmation message appears, select “OK” and press the [SET] button.

The LOAD USER DATA menu item is redisplayed.

SYSTEM

SYSTEM MODE

SYSTEM > SYSTEM MODE

_ is the factory default setting.

| Item | Settings and brief function description |
|----------------|--|
| LINE&FREQ | <p>Sets the number of lines and frequency of the system, recording format, and audio quantization bit rate. When the number of lines and frequency are selected, only the items that can be set with that frequency are displayed. When the frequency is changed, the unit needs to be restarted. A dialog appears when a restart is required.</p> <p>1080-59.94P: Selects 1080p for the number of lines and 59.94 Hz for the system frequency.</p> <p>1080-50P: Selects 1080p for the number of lines and 50 Hz for the system frequency.</p> <p>1080-59.94i: Selects 1080i for the number of lines and 59.94 Hz for the system frequency.</p> <p>1080-50i: Selects 1080i for the number of lines and 50 Hz for the system frequency.</p> <p>720-59.94P: Selects 720p for the number of lines and 59.94 Hz for the system frequency.</p> <p>720-50P: Selects 720p for the number of lines and 50 Hz for the system frequency.</p> <p>480-59.94i: Selects 480i for the number of lines and 59.94 Hz for the system frequency.</p> <p>576-50i: Selects 576i for the number of lines and 50 Hz for the system frequency.</p> |
| REC FORMAT | <p><"LINE&FREQ" submenu> Selects the recording codec.</p> <p>AVC-I200/**: Selects AVC-Intra200.</p> <p>AVC-I100/**: Selects AVC-Intra100.</p> <p>AVC-I50/**: Selects AVC-Intra50.</p> <p>AVC-G50/**: Selects AVC-LongG50.</p> <p>AVC-G25/**: Selects AVC-LongG25.</p> <p>AVC-G12/**: Selects AVC-LongG12.</p> <p>DVCPRO HD/**: Selects DVCPRO HD (100 Mbps).</p> <p>DVCPRO50/**: Selects DVCPRO50 (50 Mbps).</p> <p>DVCPRO/**: Selects DVCPRO (25 Mbps).</p> <p>DV/**: Selects DV (25 Mbps).</p> <p>Note: The frame rate of the recording will be displayed for "**" of each setting value. However, 59.94 will be displayed as "60."</p> |
| AUDIO SMPL RES | <p>Selects the quantization bit rate for audio recording in the AVC-Intra 100 or AVC-Intra 50 recording format.</p> <p>16BIT: Sets the audio recording bit rate to 16 bit.</p> <p>24BIT: Sets the audio recording bit rate to 24 bit.</p> <p>Note: The audio recording bit rate is 24 bit when the recording format is AVC-Intra200, AVC-LongG50, or AVC-LongG25, and 16 bit when the recording format is AVC-LongG12, DVCPRO HD, DVCPRO50, DVCPRO, or DV, regardless of the setting of this item.</p> |

SYSTEM SETUP

SYSTEM > SYSTEM SETUP

_ is the factory default setting.

| Item | Settings and brief function description | FREQ indications |
|----------|---|-----------------------------------|
| AV PHASE | <p>Adjusts the phase of audio output in relation to the video output (in 20.8 μs steps).</p> <p>-128 to Q to 127</p> <p>-: Advances the phase of audio output in relation to the video output.</p> <p>+: Delays the phase of audio output in relation to the video output.</p> | <p>59.94Hz 50Hz</p> |
| GPS | <p>Sets whether location data will be acquired from external devices that are connected via network to this unit.</p> <p>When location data cannot be acquired, it will not be recorded in the metadata.</p> <p>EXTERNAL: Acquires location data.</p> <p>OFF: Does not acquire location data.</p> | <p>59.94Hz 50Hz</p> |

SYSTEM > SYSTEM SETUP (Continued)

| Item | Settings and brief function description | FREQ indications |
|----------------|---|----------------------------|
| P.OFF GPS DATA | When "EXTERNAL" on the "GPS" (→ page 114) menu item is selected, this selects whether the location data will be saved when the power on this unit is switched off. HOLD: Location data will be saved (held), and this data will be used when recording from the time that this unit is powered on next until new location data is acquired. CLEAR: Location data will be cleared, and location data will not be recorded from the time that this unit is powered on next until new location data is acquired. | 59.94Hz 50Hz |

HOURS METER

SYSTEM > HOURS METER

| Item | Settings and brief function description |
|------------|---|
| OPERATION | Displays the total time that the power of the unit has been on. |
| P.ON TIMES | Displays the total number of times that the power of the unit has been turned on. |
| LCD | Displays the total time that the LCD monitor of the unit has been lit. |
| FAN | Displays the total time that the fan of the unit has been rotating. |

VERSION

SYSTEM > VERSION

Displays the various versions of the unit.

| Item | Settings and brief function description |
|------------|---|
| VERSION | Displays the overall firmware version (representative version) of the unit. |
| MODEL NAME | Displays the model name of the unit. |
| SERIAL NO. | Displays the serial number of the unit. |
| NETWORK ID | Displays the network ID of the unit. |
| UID | Displays the unique ID of the unit. |

OPTION MENU

SYSTEM > OPTION MENU

The option menu can be displayed by pressing the [MENU] button while pressing the [DISPLAY] button.

_ is the factory default setting.

| Item | Settings and brief function description |
|---------------|--|
| INT LOCK MODE | Sets whether to use the function that switches the signal reference for the LCD display and output signals from the input signals to the internal free signals. This functions only for HDMI input. This can be used if there is a discrepancy in the frequency of the HDMI input signal and reception is not possible with the unit. ON: Enables free signal reference mode. OFF: Enables standard mode. Note: <ul style="list-style-type: none"> Dropped frames, identical continuous frames, image overlap, and other problems may occur in the LCD display, output signals, and recorded video. When the INT LOCK MODE function is operating, "INT LOCK" is displayed in the additional information display area on the LCD monitor. |
| AREA SETTING | Selects the area of use for the unit. The following settings can be set in the "AREA SELECT" screen. NTSC: Selects an NTSC area other than Japan. NTSC (J): Selects Japan. PAL: Selects a PAL area. |

List of Compatible Input and Output Formats

The following shows the compatible input/output formats that can be set in the “LINE&FREQ”, “REC FORMAT”, and other menu items.

| Compression formats “REC FORMAT” | Sampling | Quantization | Video formats “LINE&FREQ” | | |
|-------------------------------------|----------|--------------|---------------------------|-----------------------|--------------------------------|
| | | | 1080-59.94i 1080-50i | 720-59.94p 720-50p | 1080-59.94p 1080-50p |
| AVC-Intra200 | 4:2:2 | 10 bit | Recording/playback | Recording/playback | |
| AVC-Intra100 | 4:2:2 | 10 bit | Recording/playback | Recording/playback | Recording/playback <3G-SDI> |
| AVC-Intra50 | 4:2:0 | 10 bit | Recording/playback | Recording/playback | |
| AVC-LongG50 | 4:2:2 | 10 bit | Recording/playback | Recording/playback | |
| AVC-LongG25 | 4:2:2 | 10 bit | Recording/playback | Recording/playback | Recording/playback <3G-SDI> |
| AVC-LongG12 | 4:2:0 | 8 bit | Recording/playback | Recording/playback | Recording/playback <3G-SDI> |
| DVCPRO HD | 4:2:2 | 8 bit | Recording/playback | Recording/playback | |

| Compression formats “REC FORMAT” | Sampling | Quantization | 480-59.94i 576-50i |
|-------------------------------------|----------|--------------|-----------------------|
| DVCPRO50 | 4:2:2 | 8 bit | Recording/playback |
| DVCPRO | 4:1:1 | 8 bit | Recording/playback |
| DV | --- | 8 bit | Recording/playback |

Using a Keyboard

Full Keyboard

The full keyboard is displayed when metadata input or other alphanumeric input is required.

Move the cursor to the character you want to enter and press the [SET] button.

Use the cursor buttons to move the cursor.

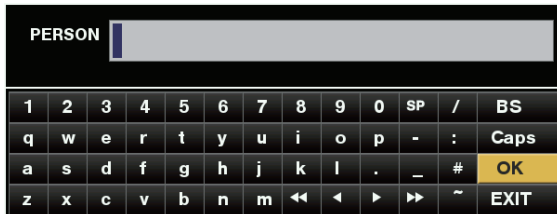

The keys on the keyboard have the functions listed below.

| Key | Function |
|------|---|
| BS | Deletes one character. |
| Caps | Toggles between upper and lower case. |
| OK | Saves the entered characters and closes the software keyboard. |
| EXIT | Discards the entered characters and closes the software keyboard. |
| ◀◀ | Moves the cursor to the first character. |
| ◀ | Moves the cursor 1 character space back |
| ▶ | Moves the cursor 1 character space forward |
| ▶▶ | Moves the cursor to the location after the last character |

◆ Note:

- Pressing the [RESET] button deletes all entered characters.
- Pressing the [EXIT] button displays a confirmation message before exiting the keyboard. Select "YES" and press the [SET] button to close the software keyboard.
- Switching Caps also changes the symbols on the keyboard.

Numeric Keyboard

The numeric keyboard is displayed when you only need to enter numbers.

Move the cursor to the number you want to enter and press the [SET] button.

Use the cursor buttons to move the cursor.



The keys on the keyboard have the functions listed below.

| Key | Function |
|------|--|
| BS | Deletes one character. |
| OK | Saves the entered characters and closes the software keyboard. |
| EXIT | Discards the entered characters and closes the software keyboard. |
| ◀ | <When entering decimals> Moves the cursor 1 character space back <When entering a time code> Moves the cursor 1 item space back |
| ▶ | <When entering decimals> Moves the cursor 1 character space forward <When entering a time code> Moves the cursor 1 item space forward |

USB Keyboard

To use a USB keyboard for input, connect it to the USB 3.0 connector when a menu that displays the full keyboard or numeric keyboard is selected.

The type of keyboard must first be set in the menu. (→ "KEYBOARD" page 102 menu item)

◆ Note:

- Input is limited to alphanumeric characters and symbols.
- Some keyboards may not work properly.

For Long and Trouble-Free Operation

Maintenance

Do not use benzine or thinner for cleaning.

- Benzine and thinner may deform the unit and cause the paint to peel off.
- Remove any DC input and disconnect the power cable from the outlet before cleaning.
- Wipe the unit using a soft clean cloth. In the case of stubborn dirt, wipe off the dirt using a cloth dampened with a solution of a neutral detergent and water and then wipe with a dry cloth.

Condensation

Condensation occurs due to the same principle involved when droplets of water form on a window pane of a heated room. It occurs when the unit or a card is moved between places where the temperature or humidity varies greatly or when, for instance:

- It is moved to a very humid place full of steam or to a room immediately after heating of the room.
- It is suddenly moved from a cold location to a very hot or humid location.

When moving the unit to locations such as these, leave it standing for about 10 minutes rather than switching on the power immediately.

Storage Precautions

Store the unit in a location where the humidity is low and the temperature is relatively constant.

Recommended ambient temperature: 15 °C to 25 °C (59 °F to 77 °F)

Recommended relative humidity: 40% to 60%

■ Unit

- Wrap the unit in a soft cloth to protect it from dust.
- Do not place the unit in a location exposed to direct sunlight, as the finish and LCD screen may be damaged.

■ P2 cards and SD memory cards

- After removing a P2 memory card from the unit, be sure to attach the card cap to protect the card connector from sand and dust. Then, place the card in its case before storing or transporting it.
- After removing a microP2 memory card or SD memory card from the unit, be sure to place it in its case.
- Do not leave cards in locations where corrosive gases are present.
- Do not leave cards in automobiles, locations exposed to direct sunlight, or other locations where the temperature will become high.
- Do not leave cards in high humidity or excessively dusty locations.

Warning System

Warning Details

When an error is detected after the power is turned on or during operation, the  (POWER) lamp and a beep sound notify you that an error has occurred.

◆ **Note:**

If multiple errors occur simultaneously, the one with the highest priority is displayed.

1. System error

| | |
|--|---|
| Monitor display | Displays the error code. |
|  (power) lamp | Flashes 4 times per second. |
| Card Access Lamp | |
| Beep sound | Repeats rapidly. |
| Warning description | A reference signal error or communication error occurred. |
| Recording/playback operation | Stops. |
| Measure | Check the error code table and consult with your dealer. |

2. Format inconsistency

| | |
|--|--|
| Monitor display | Displays the error code. |
|  (power) lamp | Flashes 4 times per second. |
| Card Access Lamp | |
| Beep sound | Repeats rapidly. |
| Warning description | SYSTEM mode is internally inconsistent and a restart is required. |
| Recording/playback operation | Not possible |
| Measure | Turn the power off and then back on as described in the message and then check that an error is not displayed. |

3. Card eject error

| | |
|--|---|
| Monitor display | Displays the error code. |
|  (power) lamp | Flashes 4 times per second. |
| Card Access Lamp | |
| Beep sound | Repeats rapidly. |
| Warning description | An error occurred in the internal memory of the unit because a P2 card was removed during access. |
| Recording/playback operation | Not possible |
| Measure | Turn the power off and then back on as described in the message. Check that there is no problem with the clips on the removed card and repair the clips if necessary. |

4. Recording error / recording stopped

| | |
|--|--|
| Monitor display | Displays "REC WARNING." |
|  (power) lamp | Flashes 4 times per second. |
| Card Access Lamp | |
| Beep sound | Repeats rapidly. |
| Warning description | <ul style="list-style-type: none"> • An error has occurred with the recording circuit settings. • Recording cannot continue due to an error. |
| Recording/playback operation | Recording may continue or may stop. |
| Measure | Refer to "Display of warning information" (→ page 120). |

Error Codes

| Code No. | Displayed message | Description | Operation |
|----------|---------------------------------|---|----------------------|
| E-30 | TURN POWER OFF <P2 CARD> | Displayed when an error occurs in reading and writing card data. To continue operation, turn the power off and then back on. | Card removal error |
| E-31 | TURN POWER OFF <SYSTEM MODE> | System mode error To continue operation, turn the power off and then back on. | Format inconsistency |
| E-35 | SYSTEM ERROR <CODEC> | CODEC microprocessor error To continue operation, turn the power off and then back on. | System error |
| E-36 | SYSTEM ERROR <P2 SYSTEM> | P2CS microprocessor error (error notification) To continue operation, turn the power off and then back on. | System error |
| E-37 | SYSTEM ERROR <P2CS> | P2CS microprocessor error (communication disconnected) To continue operation, turn the power off and then back on. | System error |
| E-39 | SYSTEM ERROR <INITIALIZE> | Video initialization error To continue operation, turn the power off and then back on. | System error |
| E-50 | BATTERY TOO LOW | Displayed when the battery voltage is below the undercut voltage. | Low voltage |

Display of warning information

When a warning occurs, a message is displayed on the OSD display and information display.

| Displayed message | Description | Deck operation |
|-------------------|---|----------------|
| CANNOT REC | Displayed when data cannot be recorded on a P2 card. [Cause] <ul style="list-style-type: none"> • The card is write protected. • No more free space on the card. • Recording was attempted on a card that cannot be used. • Card status changed during recording. • Recording was attempted when the unit was BUSY. | STOP |
| CANNOT LOOP REC | Displayed when data cannot be recorded to a P2 card while the "RECORDING" (→ page 97) menu item is "LOOP." [Cause] <ul style="list-style-type: none"> • The card is write protected. • No more free space on the card. • Recording was attempted on a card that cannot be used. • Card status changed during recording. • Recording was attempted when the unit was BUSY. | STOP |
| CANNOT PLAY | Displayed when playback was interrupted due to a clip error or other factor. [Cause] <ul style="list-style-type: none"> • Playback was attempted when there were no clips. • Playback was attempted for a card that cannot be used. • Other causes that prevent playback or stop playback. • Playback was attempted when the unit was BUSY. | STOP |

| Displayed message | Description | Deck operation |
|----------------------------------|---|---------------------|
| BATTERY NEAR END | The voltage of the battery is low. Replace the battery. | Operation continues |
| SLOT SEL INVALID | Displayed if the [SLOT SEL] button (when assigned to a [USER] button) is pressed when it is not possible to switch the P2 card recording slot. | Operation continues |
| BUSY | Displayed while the clip information is being read or when the clip configuration has changed. No operations can be performed while BUSY is on the screen. [Cause] <ul style="list-style-type: none"> • A card has been inserted or removed. • Updating is in progress • Recording post processing is in progress • Other causes | Operation continues |
| FAN STOPPED | Displayed when the fan motor is stopped. The power turns off automatically 30 seconds after the message appears. Also a beep sound is output for 30 seconds. Immediately stop using the unit and then turn off the power and contact your dealer. | Operation continues |
| BACKUP BATT EMPTY | Displayed when a drop in the backup battery voltage for the internal clock is detected at power-on. Refer to "About the battery of the internal clock" (→ page 25). | Operation continues |
| REC WARNING <FRAME SIGNAL> | Displayed when a video or audio error occurs during recording. To continue operation, turn the power off and then back on. If the input signal becomes disrupted during recording, recording will continue but disrupted video will be recorded. Check the signal input to the unit. Even if recording is continued, video and sound will be recorded correctly when the signal returns to normal. | Continues |
| TEMPORARY PAUSE IRREGULAR SIG | Displayed when a video or audio error occurs during recording, and recording is paused. Recording will be resumed automatically when the signal returns to normal. The clip will be divided. The time code may become non-continuous. When recording in AVC-G format, remove and reinsert the card after recording is complete, and repair the clips for which "NG" (yellow) is displayed. | Recording pauses |
| REC WARNING <OVER MAX# CLIPS> | Displayed when an attempt was made to record a clip that would result in the upper limit for the total number of clips being exceeded on one P2 card. Replace the P2 card or delete unnecessary clips. It is displayed after approximately 3.5 hours have elapsed from the time when operation to start a single recording is executed when [SHORT SPLIT] is selected in the [FILE SPLIT] menu (→ page 98). The recording is stopped. | STOP |

| Displayed message | Description | Deck operation |
|------------------------|--|------------------------------|
| CARD ERROR <****> | Displayed when a data error caused by the P2 card occurred during recording. It remains displayed after recording stops until the following operation is performed. Furthermore, it is displayed for 3 seconds when playback is stopped due to a P2 card error during playback. (** is the slot number mark for indicating where the error occurred.) Replace the P2 card in the slot where the error occurred. | STOP |
| REC WARNING <REC DATA> | Displayed when an error occurs with the recording data during recording. Turn the power off and then back on, then try again. | Operations continues or STOP |
| DIR NG CARD <****> | The directory configuration is incorrect. Immediately back up the card data and format the card before using it again. (** is the slot number mark for indicating where the error occurred.) | Operation continues |
| RUNDOWN CARD <****> | The card has been rewritten the maximum number of times. Replacing the P2 card is recommended. (** is the slot number mark for indicating where the error occurred.) | Operation continues |
| SD CARD <*> | An SDHC/SDXC memory card is inserted in a microP2 memory card slot. (** is the slot number mark for indicating where the error occurred.) Operation will continue but recording to a microP2 memory card or P2 memory card is recommended. | Operation continues |
| REC IMPOSSIBLE <*> | An SDHC/SDXC memory card is inserted in a P2 card slot, and recording is not possible in the current system mode. (** is the slot number mark for indicating where the error occurred.) Change the system mode (→ page 114) or record to a microP2 memory card or P2 memory card. | Operation continues |
| AUTH NG CARD <*> | CPS authentication of the microP2 memory card failed. (** is the slot number mark for indicating where the error occurred.) Recording and playback are not possible with a microP2 memory card for which CPS authentication has failed. Refer to “Manual and Automatic CPS Authentication” (→ page 55) and then change the settings. | Operation continues |
| STORAGE INTERMITTENT | When playing a clip from a storage device, displayed for approx. 3 seconds when reduced storage device performance or another factor has resulted in intermittent clip playback. Use a storage device with higher specifications. | Operation continues |
| PB INTERMITTENT | Intermittent playback occurs with an SDHC/SDXC memory card. A card for which playback performance cannot be guaranteed is inserted. Using a microP2 memory card or P2 memory card is recommended. | Operation continues |
| PROXY ERROR | Operation and cause: Proxy data recording stops but the recording of this material continues. | Operation continues |
| PROXY REC WARNING | <ul style="list-style-type: none"> • Electric circuit error (PROXY ERROR) • Proxy data recording error (PROXY REC WARNING) • When a proxy data recording error occurs, the proxy data being recorded is processed as follows. <ul style="list-style-type: none"> - The proxy data being recorded to a P2 card is deleted. - The proxy data being recorded to an SD memory card is not deleted or repaired. | |

| Displayed message | Description | Deck operation |
|-------------------------|--|---------------------|
| SIMUL REC WARNING <***> | Displayed when an error occurs with one of the cards during simultaneous recording. (** is the slot number mark for indicating where the error occurred.) Recording will stop on the card on which the error occurred, but will continue on the other card. | Operation continues |
| CHECK SLOT <***> | The memory card may not be recognized correctly due to reasons such as the microP2 memory card being inserted slowly or dirt on the terminal of the memory card. - Recording cannot be performed on the inserted microP2 memory card. - Check the microP2 memory card that is inserted. (** is the slot number mark for indicating where the error occurred.) | Operation continues |
| LAN ERROR | Displayed when the LAN connection or disconnection failed. To continue operation, turn the power off and then back on. If the message is displayed again, consult with your dealer. | STOP |
| UP LIST #99/100 | The number of registrations in the upload list of the rec during upload function has reached 99. One more clip to the upload list can be registered. Delete unnecessary clips in the upload list. | Operation continues |
| UP LIST #100/100 | The number of registrations in the upload list of the rec during upload function has reached the upper limit. When more additional clips need to be registered, delete unnecessary clips in the upload list. | Operation continues |
| UP LIST OVER MAX | Clips cannot be added for registration because the number of registrations in the upload list of the rec during upload function has reached the upper limit. When additional clips need to be registered, delete unnecessary clips in the upload list. | Operation continues |
| INVALID TC MODE | Displayed during playback when the time code has been recorded in drop frame mode. The video output is distorted and audio output is muted at the drop point of the time code. Check the playback clip. Playing back a 24P frame-rate clip requires that the time code be recorded in non-drop frame mode. Displayed when the time code in an HD SDI input is in the drop frame mode during EE or recording. Normal recording will not be possible under these conditions. | Operation continues |
| INT SG | Displayed for the first two seconds when the [REC] button is pressed to switch to EE mode while "INT SG" is selected in the "INPUT SEL" (→ page 103) menu setting. | Operation continues |
| NO INPUT | If there is no input signal to the connector selected in "INPUT SEL" (excluding analog audio), this is displayed for 2 seconds after you press the [REC] button to switch to EE mode. | Operation continues |
| INVALID INPUT FORMAT | Displayed when the input signal of the connector selected by "INPUT SEL" is a signal that cannot be received. The input signal is muted. | Operation continues |
| HDCP EXISTED | Displayed when an HDCP signal is detected while the HDMI input is selected. Note that recording is not possible when an HDCP signal is detected. SDI/HDMI and streaming video outputs are also not possible. | Operation continues |

Display of thumbnail warning information

| Item | Message | Description | Measure |
|----------------|--------------------------------|---|---|
| Thumb- nail | CANNOT ACCESS! | The data cannot be accessed because, for example, the content is corrupted. | Restore the media and clips to their normal states before access. |
| | CANNOT CHANGE! | The thumbnail cannot be changed for a text memo that is indicated by a gray  because the thumbnail could not be generated. | Edit the settings or content to enable thumbnail display. |
| | CANNOT DELETE! | Deletion is not possible because the content versions do not match. | Match the device and content versions. |
| | CANNOT FORMAT! | Formatting is not possible because of a problem with the P2 card, etc. | Check the P2 card. |
| | CANNOT RE-CONNECT! | Clip reconnection is not possible because, for example, content that is not a clip spanning multiple cards is selected. | Check the selected content. |
| | CANNOT REPAIR IN SELECTION! | Some of the selected clip could not be repaired. | Check the selected content. |
| | CANNOT REPAIR! | Content that cannot be repaired is selected. | Check the selected content. |
| | CANNOT SAVE! FILE NAME IN USE | A configuration file with the same file name already exists on the SD memory card. | Save the file under a different name. |
| | CARD FULL! | The P2 card or SD memory card is full. | Insert media with sufficient free space. |
| | INVALID VALUE! | The entered data is invalid. | Enter data in a valid range. |
| | LACK OF CAPACITY! | There is not enough recording space left on the card. | Insert a card with sufficient recording space. |
| | MISSING CLIP! | A shot mark cannot be added to a clip that spans multiple P2 cards if all of the segments are not available. | Insert all of the P2 cards on which the clip was recorded. |
| | NO CARD! | No P2 card or SD memory card is inserted. | Insert compatible media. |
| | NO FILE! | The designated file does not exist. | Check the file. |
| | NO COPY TO SAME CARD! | Copying is not possible because the copy source and copy destination are the same. | Copy to a card that does not contain the selected clip. |
| | NO INPUT! | No data is input. | Input data and then set the setting. |
| NO SD CARD! | No SD memory card is inserted. | Insert an SD memory card. | |

| Item | Message | Description | Measure |
|------------|--|--|---|
| Thumb-nail | NOT SELECTED! | An attempt was made to delete when no clip was selected. | Select the clip you want to delete. |
| | SAME CLIP IS SELECTED! | The selected clips contain multiple copies of the same clip (duplicated by copying). | Multiple copies of the same clip (duplicated by copying) cannot be simultaneously copied. Deselect all of the selected clips that are identical copies. |
| | TOO MANY CLIPS! | Too many clips are selected. | Reduce the number of selected clips. |
| | UNKNOWN CONTENTS FORMAT! | This warning is for when the version of the content is not compatible with the unit. | Match the device and content versions. |
| | UNKNOWN DATA! | <ul style="list-style-type: none"> The metadata character code is invalid. There is a problem with the data in the file. | <ul style="list-style-type: none"> Use UTF-8 for the metadata character code. Use the viewer to enter the correct characters. Create the file again. |
| | USER CLIP NAME MODIFIED! | Characters need to be deleted when the counter value is added to the clip name. | Only up to 100 bytes can be saved for the combination of the user clip name and counter value so characters are deleted automatically when the total exceeds that amount. |
| | WRITE PROTECTED! | The P2 card or SD memory card is write protected. | Insert write-enabled media. |
| | CANNOT OPERATE THIS MENU, WHILE "REC DURING UPLOAD" ENABLED. | The menu cannot be executed. | Change the "REC DURING UPLOAD" menu item setting to "DISABLE" before executing. |
| Storage | CANNOT ACCESS CARD! | An error occurred during P2 card access. | Check the P2 card. |
| | CANNOT ACCESS TARGET! | An error occurred while attempting to access the connection target. | Check the storage device status and connection. |
| | CANNOT COPY! FORMAT STORAGE DEVICE TO FAT | The clips cannot be copied because there is no partition to which to copy clips on the storage device. | Reformat in FAT format or export the data from a P2 card to create a partition. |
| | CANNOT FORMAT! | The storage device cannot be formatted. | Connect a different storage device. |
| | CANNOT RECOGNIZE STORAGE DEVICE! | The storage device cannot be recognized properly. | Reboot the storage device or connect a different storage device. |
| | CANNOT SELECT! MAX.6 PARTITIONS | A storage device with more than six partitions cannot be selected (simultaneous mounting of partitions). | Cancel some of the selected partitions. |
| | CARD IS EMPTY! CANNOT COPY! | The P2 card to be copied is empty. | Copying will not be performed since the card is empty. |
| | FORMAT P2 CARD! | Importing to a P2 card containing clips is not possible. | Format the P2 card. |

| Item | Message | Description | Measure |
|-------------------|---------------------------|--|---|
| Storage | LACK OF CAPACITY! | Not enough free space left on the storage device. | Use a new storage device with enough free space or a formatted storage device. |
| | MISMATCH COMPONENT! | The model numbers of the copy source P2 card and copy destination P2 card do not match. Copying is not possible. | Use P2 cards of the same model number or import clips individually. |
| | TOO MANY PARTITIONS! | There are too many partitions. | The maximum number of partitions for a storage device is 23. Use a new storage device or reformat the storage device. |
| | UNKNOWN DEVICE CONNECTED! | An unsupported DVD drive or other device is connected. | Connect a supported storage device, and then turn the power off and then back on. |
| | VERIFICATION FAILED! | Verification after copying failed. | Copy the data again. |
| Software keyboard | CANNOT CHANGE! | An attempt was made to change PERSON when no text memo had been entered. | First enter a text memo. |
| | CANNOT SET! | The entered value is invalid. | Enter a valid value. |
| | INVALID VALUE! | | |
| | AUTHENTICATION ERROR! | Manual authentication failed. | Enter the correct password. |
| Network | CANNOT CONNECT! | A connection cannot be established to the network. | Check that the LAN settings are correct, LAN cable is connected properly, and network is working properly. |
| | CANNOT FIND FTP-SERVER! | The connection destination FTP server cannot be found. | Check whether the URL item of FTP CLIENT is correct. |
| | LOGIN FAILED! | Logging in to the connection destination FTP server failed. | Check whether the USER ID and USER PASSWORD items of FTP CLIENT are correct. |
| | PING FAILED! | The ping failed. | Check that the LAN settings and the URL item of FTP CLIENT are correct, LAN cable is connected properly, and network is working properly. |
| | CANNOT ACCESS GATEWAY! | The gateway server cannot be accessed. | Check that the LAN settings are correct. |
| | CHECK LAN SETTING | The gateway server cannot be accessed. | Check that the LAN settings are correct. |
| | IP ADDRESS IS USED! | The set IP ADDRESS is being used by another device. | Consult with the network administrator and then set another IP ADDRESS. |
| | INVALID VALUE! | The entered data is invalid. | Enter data in a valid range. |
| | UPLOAD LIST ERROR! | Addition to the upload list failed. | <ul style="list-style-type: none"> • Configure "REC DURING UPLOAD" (→ page 105) again. • Check whether the registration limit (100 entries) for the upload list has been reached. |

Updating the Firmware in This Unit

Check the firmware version of the unit in the "SYSTEM" - "VERSION" (→ page 115) menu item and then access the following website to check the most recent firmware information and download the firmware if necessary.

Download the update file, place the update file on an SD memory card, and then insert the SD memory card in the unit.

For how to update the firmware, visit the Panasonic website (→ "Website URL" page 9).

◆ **Note:**

Only use SD memory cards that comply with the SD, SDHC, or SDXC standards in this unit.

Be sure to format the SD memory cards with this unit.

Specifications

General

Power supply: 7.28 V DC (=) (during battery use)
 12 V DC (=) (during AC adaptor use)
 Power consumption: 21.4 W

 indicates safety information.

| | |
|----------------------------------|---|
| Ambient operating temperature: | 0 °C to 40 °C (32 °F to 104 °F) |
| Ambient operating humidity: | 10% to 80% (non-condensing) |
| Ambient storage temperature: | -20 °C to 50 °C (-4 °F to 122 °F) |
| Weight: | 1.1 kg (2.4 lbs) |
| Dimensions (W×H×D): | 108 mm × 85 mm × 217 mm (4-1/4 inches × 3-3/8 inches × 8-9/16 inches) (Excluding the foot parts and protrusions such as the cap) |
| Recording media: | P2 memory cards, microP2 memory cards |
| Recording formats: | AVC-Intra200/AVC-Intra100/AVC-Intra50/AVC-LongG50/AVC-LongG25/AVC-LongG12 DVCPRO HD/DVCPRO50/DVCPRO/DV formats are selectable. |
| Proxy file formats: | MOV (QuickTime format) |
| Proxy video compression formats: | H.264/AVC Baseline Profile, H.264/AVC High Profile |
| Proxy audio: | AAC-LC, Linear PCM |
| Video recording signals: | 1080/59.94p, 1080/50p, 1080/59.94i, 1080/50i, 720/59.94p, 720/50p, 480/59.94i, 576/50i |
| Audio recording signals: | AVC-Intra200/AVC-LongG50/AVC-LongG25: 48 kHz, 24 bit, 4 channels AVC-LongG12: 48 kHz, 16 bit, 4 channels AVC-Intra100/AVC-Intra50: 48 kHz, 16 bit, 4 channels 48 kHz, 24 bit, 4 channels DVCPRO HD: 48 kHz, 16 bit, 4 channels DVCPRO50: 48 kHz, 16 bit, 4 channels DVCPRO/DV: 48 kHz, 16 bit, 4 channels |

Recording times:

| Card | Recording Method (Compression Method) 59.94 Hz/50 Hz | | | | | |
|---------|--|----------------------------|--|------------------------|------------------------|------------------------|
| | AVC-Intra200 | AVC-Intra100/ DVCPRO HD | AVC-Intra50/ AVC-LongG50/ DVCPRO50 | DVCPRO | AVC-LongG25 | AVC-LongG12 |
| 16 GB×1 | Approx. 8 minutes | Approx. 16 minutes | Approx. 32 minutes | Approx. 64 minutes | Approx. 54 minutes | Approx. 108 minutes |
| 32 GB×1 | Approx. 16 minutes | Approx. 32 minutes | Approx. 64 minutes | Approx. 128 minutes | Approx. 110 minutes | Approx. 220 minutes |
| 64 GB×1 | Approx. 32 minutes | Approx. 64 minutes | Approx. 128 minutes | Approx. 256 minutes | Approx. 220 minutes | Approx. 440 minutes |

◆ Note:

- With 1080/59.94p and 1080/50p, the times are half of those shown above.
- All of the above times apply to the continuous recording of a single clip on a P2 card.
- Depending on the number of clips recorded, the recording times may be shorter than those listed above.

VIDEO

DIGITAL VIDEO

| | |
|----------------------------|---|
| Sampling frequencies: | AVC-Intra200/AVC-Intra100/AVC-LongG50/AVC-LongG25/DVCPRO HD: (59.94 Hz) Y: 74.1758 MHz, P _B /P _R : 37.0879 MHz (50 Hz) Y: 74.2500 MHz, P _B /P _R : 37.1250 MHz |
| | AVC-Intra100/AVC-LongG25: (1080/59.94p) Y: 148.3516 MHz, P _B /P _R : 74.1758 MHz (1080/50p) Y: 148.5000 MHz, P _B /P _R : 74.2500 MHz |
| | DVCPRO50: Y: 13.5 MHz, P _B /P _R : 6.75 MHz |
| | DVCPRO: Y: 13.5 MHz, P _B /P _R : 3.375 MHz |
| Quantization: | AVC-Intra200/AVC-Intra100/AVC-Intra50/AVC-LongG50/AVC-LongG25: 10 bit AVC-LongG12/DVCPRO HD/DVCPRO50/DVCPRO/DV: 8 bit |
| Video compression methods: | AVC-Intra200/AVC-Intra100/AVC-Intra50: MPEG-4 AVC/H.264 Intra Profile AVC-LongG50/AVC-LongG25/AVC-LongG12: MPEG-4 AVC/H.264 High Profile DVCPRO HD: DV-Based Compression (SMPTE ST 370) |
| Color sampling: | AVC-Intra200/AVC-Intra100/AVC-LongG50/AVC-LongG25: Y:P _B :P _R = 4:2:2 |
| Resolution: | AVC-Intra100/AVC-LongG25/AVC-LongG12: 1920 × 1080 (1080/59.94p, 1080/50p) AVC-Intra200/AVC-Intra100/AVC-LongG50/AVC-LongG25/AVC-LongG12: 1920 × 1080 (1080/59.94i, 1080/50i) 1280 × 720 (720/59.94p, 720/50p) AVC-Intra50: 1440 × 1080 (1080/59.94i, 1080/50i) 960 × 720 (720/59.94p, 720/50p) |

VIDEO INPUT

| | |
|-------------|---|
| SDI input: | BNC × 1 |
| HDMI input: | HDMI × 1 (HDMI TYPE A connector) (VIERA Link not supported, HDCP supported) |

VIDEO OUTPUT

| | |
|--------------------------------|---|
| SDI output (HD/SD selectable): | BNC × 1 |
| HDMI output: | HDMI × 1 (HDMI Type A connector) (VIERA link not supported) |

◆ Note:

When "VIDEO" – "INPUT SEL" is set to "HDMI", video, audio, and other signals from the HDMI output connector will not be output.

AUDIO

DIGITAL AUDIO

| | |
|---------------------|---|
| Sampling frequency: | 48 kHz (synchronized with video) |
| Quantization: | 16 bit (AVC-LongG12/DVCPRO HD/DVCPRO50/DVCPRO/DV) 16 bit/24 bit selectable (AVC-Intra 100/AVC-Intra 50) 24 bit (AVC-Intra200/AVC-LongG50/AVC-LongG25) |
| Headroom: | 12 dB/18 dB/20 dB (selectable) |
| De-emphasis: | T1=50 μ s, T2=15 μ s (ON/OFF auto select) |

AUDIO INPUT

| | |
|---------------------------|---------------------------------|
| Analog inputs (CH1, CH2): | XLR \times 2 |
| SDI input: | BNC \times 1 |
| HDMI input: | 2 channels (linear PCM), 16 bit |

AUDIO OUTPUT

| | |
|--------------------------------|---|
| SDI output: | BNC \times 1 |
| Analog output (monitor (L/R)): | Stereo mini jack (3.5 mm (1/8 inches) dia.) |
| Headphone output: | Stereo mini jack (3.5 mm (1/8 inches) dia.), variable level |
| HDMI output: | 2 channels (linear PCM), 16 bit |
| Internal speaker: | Round \times 1 (monaural) |

OTHER I/O

| | |
|------------------|---|
| Time code input: | BNC \times 1, 0.5 V[p-p] to 8.0 V[p-p], 10 k Ω |
| LAN: | RJ-45 \times 1, 100BASE-TX/10BASE-T |
| USB HOST: | USB 3.0 Host (Type A) \times 1 |
| USB device: | USB 2.0 Device (Type B) \times 1 |

AC adaptor

Power source: 100 V - 240 V AC (\sim), 50 Hz/60 Hz, 1.2 A
Power output: 12 V DC (\equiv), 3.0 A

 indicates safety information.

| | |
|---------------------------------------|---|
| Ambient operating temperature: | 0 $^{\circ}$ C to 40 $^{\circ}$ C (32 $^{\circ}$ F to 104 $^{\circ}$ F) |
| Ambient operating humidity: | 10% to 90% (relative humidity, no condensation) |
| Weight: | Approx. 225 g (0.496 lbs.) |
| Dimensions (W \times H \times D): | 115 mm \times 37 mm \times 57 mm (4-1/2 inches \times 1-7/16 inches \times 2-1/4 inches) (excluding the DC cable section) |

Battery charger

Input voltage: 12 V DC (---), 3.0 A
Output voltage: 8.4 V DC (---), 4.0 A

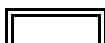
 indicates safety information.

| | |
|-----------------------------|---|
| Charging current: | Maximum 4,000 mA |
| Ambient operating humidity: | 10% to 80% (relative humidity, no condensation) |
| Weight: | Approx. 230 g (0.507 lbs.) |
| Dimensions (W×H×D): | 130 mm × 48 mm × 107 mm (5-1/8 inches × 1-7/8 inches × 4-3/16 inches) |

Battery pack

Voltage: 7.28 V DC (---)
Capacity: 5900 mAh, 43 Wh

 indicates safety information.

Inrush current, measured according to European standard
EN55103-1: 9 A

Index

| | |
|--|------------|
| Number | |
| 1 CLIP PLAY | 38, 46 |
| 3G-SDI OUT | 104 |
| 4:3 MARKER | 108 |
| 4G/LTE | 69 |
| 4G/LTE PROPERTY | 107 |
| A | |
| AC Adaptor | 12, 23 |
| Access lamp | |
| microP2 Memory Card | 16, 26 |
| P2 Memory Card | 16, 26 |
| SD/SDHC/SDXC memory card | 17 |
| Accessories | 13 |
| ACCOUNT LIST | 105 |
| Adjusting the playback audio levels | 37 |
| Adjusting the recording audio levels | 31 |
| ANALOG AUDIO IN jacks | 18 |
| APN | 107 |
| AREA SETTING | 115 |
| AUDIO | 104 |
| AUDIO LEVEL-PB button | 14 |
| AUDIO LEVEL-REC button | 14 |
| AUDIO OUT connector | 17 |
| AUDIO SMPL RES | 114 |
| AUTHENTICATE | 93 |
| AUTO POWER OFF | 24, 102 |
| AUTO REC | 32, 97 |
| AUTO UPLOAD | 105 |
| AV PHASE | 114 |
| B | |
| B CONTRAST | 109 |
| BACKLIGHT | 109 |
| Bad clip indicator | 42 |
| BAND | 106 |
| BASIC | 102 |
| Battery | 12, 22 |
| Battery attachment point | 18 |
| Battery level | 43, 85 |
| Battery lock release button | 18 |
| BEEP | 102 |
| BRIGHTNESS | 109 |
| C | |
| CANCEL button | 15 |
| CARD SERIAL | 101 |
| Card serial number | 52 |
| Card slots | 42 |
| microP2 memory cards | 16 |
| P2 memory card | 16 |
| SD/SDHC/SDXC memory card | 17 |
| CARD STATUS | 92 |
| CC REC | 98 |
| CC(F1) BLANK | 98 |
| CC(F2) BLANK | 98 |
| CHANGE PARTITION NAME | 94 |
| Changing the recording slot | 31 |
| CHANNEL (2.4GHz) | 107 |
| CHANNEL (5GHz) | 107 |
| CHARA V POSI | 108 |
| Charging the Battery | 20 |
| Charging time | 20, 21 |
| CLIP | 92 |
| Clip | |
| Copying | 48 |
| Deleting | 49, 63, 76 |
| Frame-by-frame playback | 38 |
| One clip playback | 38 |
| Playing back | 37, 45 |
| Reconnecting | 49 |
| Recording | 31 |
| Repairing | 49 |
| Repeat playback | 39 |
| Selecting | 47 |
| Variable speed playback | 37 |
| forward/rewind | 39 |
| Clip metadata | |
| Adding | 52 |
| Changing | 51 |
| Viewing | 50 |
| CLIP PROPERTY | 92 |
| CLOCK | 25, 102 |
| CODEC USAGE | 99 |
| COLOR LEVEL | 109 |
| Condensation | 118 |
| CONT. REC | 97 |
| Content protection system | 27 |
| CONTRAST | 109 |
| COPY | 93 |
| Copying | |
| Clips | 48 |
| Storage device | 60 |
| COUNTER button | 14 |
| Counter value | 52 |
| CPS | 27 |
| Automatic CPS authentication | 56 |
| Manual CPS authentication | 55 |
| CPS PASSWORD | 92 |
| CTL | 87 |
| CTL DISPLAY | 100 |
| Cursor control buttons | 15 |
| D | |
| Data | |
| Saving and loading | 112 |
| DATA DISPLAY | 94 |
| DC IN connector | 19 |
| Deck Information Display | 86 |
| DEFAULT GATEWAY | 107 |
| DELETE | 92 |
| DELETE FOLDER | 94 |
| DELETE LAST PARTITION | 94 |
| DF MODE | 100 |
| DHCP | 106, 107 |
| DHCP SERVER | 107 |
| DIAG button | 15 |
| DIAG display | 86 |
| DIAL NO. | 107 |
| DIRECT Mode | 67 |
| DISPLAY | 108 |
| DISPLAY button | 14 |
| Dividing | |
| Clips | 27 |
| DOWNCON MODE | 104 |
| Driver | 13 |
| Dual codec (proxy) recording | 33 |
| DUAL CODEC SETUP | 99 |
| E | |
| EDH(SD) | 103 |
| Edit copy indicator | 42 |
| EJECT buttons | 16 |
| ENCRYPT KEY | 107 |
| ENCRYPTION | 107 |

- Error codes 120
- EXCH. THUMBNAIL 93
- EXIT button 15
- EXPLORE 93
 - FTP server 74
 - Storage device 60
- EXPORT 93
 - Export
 - FTP server 78
 - Storage device 59
- EXT TC SEL 100
- External mode 88
- F**
 - FAN 19, 115
 - FF button 15
 - FF.REW MAX 98
 - FILE 111
 - FILE SPLIT 98
 - Firmware 127
 - FORMAT 93
 - Format
 - Storage device 58
 - FORMAT (STORAGE) 93
 - FORMAT SD CARD 111
 - Formatting
 - P2 cards 54
 - SD memory cards 54
 - Frame-by-frame playback 38, 46
 - FREE CAP. OF PARTITION 92
 - FTP client functions 74
 - FTP CLIENT SERVICE 105
 - FTP EXPLORE screen 74
 - FTP function 71
 - FTP server
 - Export 78
 - Folder list 74
 - Import 79
 - Transferring 76
 - Writing back from an FTP server 77
 - FTP thumbnail screen 75
 - Full Keyboard 117
- G**
 - G CONTRAST 109
 - GPS 114
 - GUI OUTPUT 108
- H**
 - HD EMBD LTC 101
 - HD EMBD VITC 101
 - HD/SD-SDI IN/OUT jacks 18
 - HDMI IN connector 17
 - HDMI OUT FORMAT 103
 - HDMI OUT port 17
 - Headphone jack 17
 - Hot swap recording 32
 - HOURS METER 115
 - HTTP SERVER 105
- I**
 - I/F SETUP 102
 - IMPORT 93
 - Import
 - FTP server 79
 - Storage device 64
 - Incomplete clip indicator 42
 - INDICATOR 94
 - INFORMATION SEL. 95
 - INFRA Mode 68
 - INITIALIZE 73, 101, 108, 112
 - Initializing
 - Network settings 73
 - Initializing the network settings 73
 - INPUT CH1 LEVEL 104
 - INPUT CH2 LEVEL 104
 - INPUT SEL 103, 104
 - INT LOCK MODE 115
 - INT SG 103
 - IP ADDRESS 107
- K**
 - KEYBOARD 102
 - Keyboard 117
- L**
 - LAN port 17
 - LAN PROPERTY 106
 - LCD 115
 - LCD MONITOR 109
 - LCD REVERSE 109
 - LINE&FREQ 114
 - List of compatible input and output formats 116
 - LOAD 101, 111
 - LOAD (SD CARD) 105, 106
 - LOAD FACTORY DATA 112
 - LOAD USER DATA 111
 - LOG DISPLAY 108
 - LOGIN PASSWORD 105
 - LOGIN USER 105
 - LOOP REC 32
- M**
 - MAC ADDRESS 106
 - Main Mode 31
 - Maintenance 118
 - Menu
 - Menu operations 89
 - Menu structure 90
 - MENU button 15
 - Metadata upload file 52, 53
 - microP2 memory card access lamps 16
 - microP2 memory card slots 16
 - Mode
 - P2 Playlist Editing Mode 83
 - USB Device Mode 82
 - MODE button 14
 - MODEL NAME 115
 - MONITOR CH 104
 - Monitor volume adjustment buttons 15
- N**
 - NETWORK 42, 105
 - Network Connection 65
 - NETWORK FUNC 105
 - Network Functions 72
 - NETWORK ID 115
 - NETWORK SEL 105
 - Network Settings 67
 - FTP function 71
 - Wired LAN 70
 - Wireless LAN 67
 - Network status 85
 - NETWORK TOOLS 108
 - NEXT button 15
 - Numeric Keyboard 117
- O**
 - One clip playback 38, 46
 - OPERATION 115
 - OPTION MENU 115
 - Optional Accessories 13

| | | | |
|-----------------------------------|---------|--|----------|
| OSD display | 84 | RTSP PORT | 106 |
| OSD GRADE | 108 | RUN MODE | 100 |
| OSD OUTPUT | 108 | S | |
| OSD TC SELECT | 108 | SAVE | 111 |
| OUTPUT FORMAT | 103 | SAVE (SD CARD) | 105, 106 |
| P | | SAVE AS | 111 |
| P.OFF GPS DATA | 115 | SAVE LOG (SD CARD) | 105 |
| P.ON TIMES | 115 | SAVE USER DATA | 112 |
| P2 Browser | 72 | SD CARD | 92 |
| P2 Card | 26 | SD CARD PROPERTY | 111 |
| Access Lamp | 26 | SD Memory Card | 78 |
| Checking the card status | 54 | SD memory card | 29 |
| Formatting | 54 | Formatting | 54 |
| Handling of recording data | 28 | SD/SDHC/SDXC memory card access lamp | 17 |
| Recording times | 26 | SD/SDHC/SDXC memory card slot | 17 |
| P2 memory card access lamps | 16 | SDHC memory card | 29 |
| P2 memory card slots | 16 | SDXC memory card | 29 |
| P2 Playlist | 83 | SECONDARY DNS | 107 |
| PASSWORD | 107 | SEEK POS SEL | 98 |
| PAUSE button | 15 | SERIAL NO. | 115 |
| PB POSITION | 94 | SERVER ADDR. | 106 |
| PHONES (Headphone) jack | 17 | SERVER URL | 105 |
| PING | 73, 108 | SET button | 15 |
| PLAY button | 15 | SETTING DATA | 105, 106 |
| Playback time | 20, 21 | SETUP DATA (SD CARD) | 111 |
| Playing back | | SG MOVE | 103 |
| Clips | 37, 45 | SHIFT button | 15 |
| Text memo | 46 | Shot mark | 48 |
| Power | 20, 24 | Shot mark indicator | 42 |
| Power button | 14 | SHUTTLE MAX | 98 |
| Power lamp | 14 | SIMUL REC | 32, 97 |
| POWER ON GUI | 102 | SORT | 94 |
| PREV button | 15 | Speaker | 16 |
| PRIMARY DNS | 107 | SPEAKER OUT | 104 |
| PROPERTY | 92, 101 | Specifications | 128 |
| PROPERTY DISP. | 95 | SSH | 105 |
| Proxy data | 33 | SSH PORT | 105 |
| Proxy indicator | 42 | SSID | 106 |
| PROXY REC MODE | 99 | SSID INPUT MODE | 106 |
| Q | | START TRIGGER | 106 |
| QoS MAX RATE | 99 | STATUS DISPLAY | 108 |
| QoS MIN RATE | 99 | STOP button | 15 |
| R | | STORAGE COPY SETUP | 96 |
| R CONTRAST | 109 | Storage device | 42, 57 |
| REC button | 15 | Connecting | 58 |
| REC DURING UPLOAD | 105 | Copy | 60 |
| Rec during upload function | 79 | Export | 59 |
| REC FORMAT | 114 | Format | 58 |
| REC MEDIA | 98 | Import | 64 |
| REC META DATA | 101 | Information display | 60 |
| REC/PB | 97 | Storage Precautions | 118 |
| REC/PB FUNCTION | 97 | STREAMING | 106 |
| REC/PB SETUP | 98 | Streaming function | 34 |
| RE-CONNECT | 93 | STREAMING LATENCY | 99 |
| RECORD | 101 | STREAMING MODE | 99 |
| RECORDING | 97 | STREAMING SETTING | 106 |
| Recording times | 26 | SUBNET MASK | 107 |
| Recording/playback screen | 31 | SYSTEM | 114 |
| REF LEVEL | 104 | SYSTEM MODE | 114 |
| REMAIN SETUP | 92 | SYSTEM SETUP | 114 |
| Remaining space on the card | 55, 84 | T | |
| REPAIR | 93 | TC PRESET button | 15 |
| REPEAT PLAY | 97 | TC/UB/CTL | 100 |
| Repeat playback | 39 | TCG MODE | 100 |
| REPOSITION | 92 | Text memo | 47 |
| RESET button | 14 | Deleting | 47 |
| REW button | 15 | forward/rewind | 39 |
| | | TEXT MEMO IND | 95 |

| | |
|--|---------|
| Text memo indicator | 42 |
| Thumbnail | 40 |
| Changing the thumbnail display | 44 |
| Changing | 51 |
| Displaying | 40 |
| FTP server | 75 |
| Names and functions of the parts | 41 |
| Storage device | 62 |
| Warning information | 124 |
| THUMBNAIL button | 15 |
| THUMBNAIL INFO | 95 |
| THUMBNAIL SETUP | 94 |
| THUMBNAIL SIZE | 94 |
| Time | 25 |
| Time code | 87 |
| TIME CODE IN jacks | 18 |
| TIME OUT | 109 |
| Time zone | 25 |
| TOP/BOTTOM buttons | 15 |
| TYPE | 106 |
| U | |
| UBG MODE | 100 |
| UID | 115 |
| Unknown clip indicator | 42 |
| Unplayable indicator | 43 |
| Update | 127 |
| UPLOAD LIST | 105 |
| USB 2.0 device port | 17 |
| USB 3.0 HOST port | 17 |
| USB 3.0 Type A | 17 |
| USB Device Mode | 82 |
| USB HOST port | 57 |
| USB Keyboard | 117 |
| USER | 110 |
| USER 1-3, 4-6 buttons | 15 |
| USER ACCOUNT | 105 |
| User bits | 87 |
| USER BUTTON | 110 |
| USER CLIP NAME | 52, 101 |
| USER ID | 107 |
| V | |
| Variable speed playback | 37 |
| VERIFY | 96 |
| VERSION | 115 |
| VIDEO | 103 |
| Viewing the connection log | 73 |
| VITC BLANK | 100 |
| VITC GEN | 100 |
| VITC POS-1 | 101 |
| VITC POS-2 | 101 |
| W | |
| Warning information | 120 |
| Thumbnail | 124 |
| Warnings | 119 |
| Waveform monitor display | 86 |
| WFM | 86 |
| WFM POS1 | 108 |
| WFM TYPE | 108 |
| Wide indicator | 42 |
| WIDE SEL | 103 |
| Wired LAN | 66, 70 |
| Wireless LAN | 67 |
| WIRELESS PROPERTY | 106 |
| Y | |
| Year, Month, Day | 25 |



Disposal of Old Equipment and Batteries

Only for European Union and countries with recycling systems

These symbols on the products, packaging, and/or accompanying documents mean that used electrical and electronic products and batteries must not be mixed with general household waste.

For proper treatment, recovery and recycling of old products and used batteries, please take them to applicable collection points in accordance with your national legislation.

By disposing of them correctly, you will help to save valuable resources and prevent any potential negative effects on human health and the environment.



For more information about collection and recycling, please contact your local authority, dealer or supplier.

Penalties may be applicable for incorrect disposal of this waste, in accordance with national legislation.

Note for the battery symbol (bottom symbol)

This symbol might be used in combination with a chemical symbol. In this case it complies with the requirement set by the Directive for the chemical involved.