

Panasonic®

Operating Instructions

HD Integrated Camera

Model No. **AW-HE42WP**

Model No. **AW-HE42KP**

Model No. **AW-HE42WE**

Model No. **AW-HE42KE**

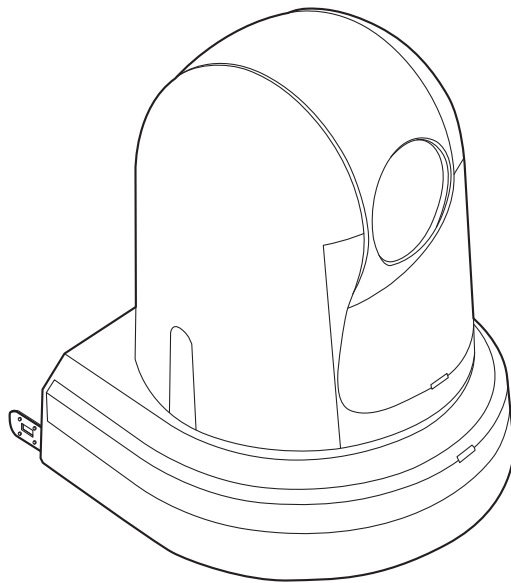

microTM
SD
XC HDMITM

Before operating this product, please read the instructions carefully and save this manual for future use. Please carefully read the "Read this first!" (pages 2 to 8) of this Manual before use.



PJ EJ

W0519RA1031 -FJ

ENGLISH
DVQP1997YA

Read this first!

(For AW-HE42WP, AW-HE42KP)

	CAUTION RISK OF ELECTRIC SHOCK DO NOT OPEN	
CAUTION: TO REDUCE THE RISK OF ELECTRIC SHOCK, DO NOT REMOVE COVER (OR BACK). NO USER SERVICEABLE PARTS INSIDE. REFER TO SERVICING TO QUALIFIED SERVICE PERSONNEL.		



The lightning flash with arrowhead symbol, within an equilateral triangle, is intended to alert the user to the presence of uninsulated “dangerous voltage” within the product’s enclosure that may be of sufficient magnitude to constitute a risk of electric shock to persons.



The exclamation point within an equilateral triangle is intended to alert the user to the presence of important operating and maintenance (servicing) instructions in the literature accompanying the appliance.

WARNING:

- To reduce the risk of fire or electric shock, do not expose this equipment to rain or moisture.
- To reduce the risk of fire or electric shock, keep this equipment away from all liquids. Use and store only in locations which are not exposed to the risk of dripping or splashing liquids, and do not place any liquid containers on top of the equipment.

WARNING:

Always keep memory cards (optional accessory) or accessories (mounting screws) out of the reach of babies and small children.

CAUTION:

This apparatus can be operated at a voltage in the range of 100 – 240 V AC. Voltages other than 120 V are not intended for U.S.A. and Canada. Operation at a voltage other than 120 V AC may require the use of a different AC plug. Please contact either a local or foreign Panasonic authorized service center for assistance in selecting an alternate AC plug.

CAUTION:

The mains plug of the power supply cord shall remain readily operable. The AC receptacle (mains socket outlet) shall be installed near the equipment and shall be easily accessible. To completely disconnect this equipment from the AC mains, disconnect the power cord plug from the AC receptacle.

CAUTION:

In order to maintain adequate ventilation, do not install or place this unit in a bookcase, built-in cabinet or any other confined space. To prevent risk of electric shock or fire hazard due to overheating, ensure that curtains and any other materials do not obstruct the ventilation.

CAUTION:

To reduce the risk of fire or electric shock and annoying interference, use the recommended accessories only.

CAUTION:

Check the installation at least once a year. An improper installation could cause the unit to fall off resulting in personal injury.

CAUTION:

Do not pick up and move the unit while the tripod is attached. The fitting may break under the weight of the tripod, which may result in injury.

CAUTION:

A coin type battery is installed inside of the unit. Do not expose the unit to excessive heat such as sunshine, fire or the like.

 indicates safety information.

Conforms to UL STD 60065.
Certified to CAN/CSA STD C22.2 No.60065.



廢電池請回收

Read this first!

(For AW-HE42WP, AW-HE42KP) (continued)

FCC NOTICE (USA)

Supplier's Declaration of Conformity

Model Number: AW-HE42WP/AW-HE42KP
Trade Name: Panasonic
Responsible Party: Panasonic Corporation of North America
Two Riverfront Plaza, Newark, NJ 07102
Support contact: 1-800-524-1448

This device complies with part 15 of the FCC Rules.
Operation is subject to the following two conditions:
(1) This device may not cause harmful interference, and (2) this device must accept any interference received, including interference that may cause undesired operation.

FCC Note:

This equipment has been tested and found to comply with the limits for a class A digital device, pursuant to Part 15 of the FCC Rules. These limits are designed to provide reasonable protection against harmful interference when the equipment is operated in a commercial environment. This equipment generates, uses, and can radiate radio frequency energy, and if not installed and used in accordance with the instruction manual, may cause harmful interference to radio communications. Operation of this equipment in a residential area is likely to cause harmful interference in which case the user will be required to correct the interference at his own expense.

Warning:

To assure continued FCC emission limit compliance, the user must use only shielded interface cables when connecting to external units. Also, any unauthorized changes or modifications to this equipment could void the user's authority to operate it.

 indicates safety information.

NOTIFICATION (Canada)

CAN ICES-3 (A)/NMB-3(A)

IMPORTANT SAFETY INSTRUCTIONS

- 1) Read these instructions.
- 2) Keep these instructions.
- 3) Heed all warnings.
- 4) Follow all instructions.
- 5) Do not use this apparatus near water.
- 6) Clean only with dry cloth.
- 7) Do not block any ventilation openings. Install in accordance with the manufacturer's instructions.
- 8) Do not install near any heat sources such as radiators, heat registers, stoves, or other apparatus (including amplifiers) that produce heat.
- 9) Do not defeat the safety purpose of the polarized or grounding-type plug. A polarized plug has two blades with one wider than the other. A grounding-type plug has two blades and a third grounding prong. The wide blade or the third prong are provided for your safety. If the provided plug does not fit into your outlet, consult an electrician for replacement of the obsolete outlet.
- 10) Protect the power cord from being walked on or pinched particularly at plugs, convenience receptacles, and the point where they exit from the apparatus.
- 11) Only use attachments/accessories specified by the manufacturer.
- 12) Use only with the cart, stand, tripod, bracket, or table specified by the manufacturer, or sold with the apparatus. When a cart is used, use caution when moving the cart/apparatus combination to avoid injury from tip-over.
- 13) Unplug this apparatus during lightning storms or when unused for long periods of time.
- 14) Refer all servicing to qualified service personnel. Servicing is required when the apparatus has been damaged in any way, such as power-supply cord or plug is damaged, liquid has been spilled or objects have fallen into the apparatus, the apparatus has been exposed to rain or moisture, does not operate normally, or has been dropped.



Read this first!

(For AW-HE42WP, AW-HE42KP) (continued)

Information on Disposal in other Countries outside the European Union



These symbols are only valid in the European Union.
If you wish to discard the item(s), please contact your local authorities or dealer and ask for the correct method of disposal.

The symbols on this product (including the accessories) represent the following.

- ~ AC
- == DC
- Class II equipment (The construction of the product is double-insulated.)

Read this first!

(For AW-HE42WE, AW-HE42KE)

WARNING:

- To reduce the risk of fire or electric shock, do not expose this equipment to rain or moisture.
- To reduce the risk of fire or electric shock, keep this equipment away from all liquids. Use and store only in locations which are not exposed to the risk of dripping or splashing liquids, and do not place any liquid containers on top of the equipment.

WARNING:

Always keep memory cards (optional accessory) or accessories (mounting screws) out of the reach of babies and small children.

WARNING:

This equipment is compliant with Class A of CISPR 32. In a residential environment this equipment may cause radio interference.

CAUTION:

Do not remove panel covers by unscrewing. To reduce the risk of electric shock, do not remove the covers. No user serviceable parts inside. Refer servicing to qualified service personnel.

CAUTION:

The mains plug of the power supply cord shall remain readily operable.
The AC receptacle (mains socket outlet) shall be installed near the equipment and shall be easily accessible. To completely disconnect this equipment from the AC mains, disconnect the power cord plug from the AC receptacle.

CAUTION:

In order to maintain adequate ventilation, do not install or place this unit in a bookcase, built-in cabinet or any other confined space. To prevent risk of electric shock or fire hazard due to overheating, ensure that curtains and any other materials do not obstruct the ventilation.

CAUTION:

To reduce the risk of fire or electric shock and annoying interference, use the recommended accessories only.

CAUTION:

Check the installation at least once a year. An improper installation could cause the unit to fall off resulting in personal injury.

CAUTION:

Do not pick up and move the unit while the tripod is attached.
The fitting may break under the weight of the tripod, which may result in injury.

CAUTION:

A coin type battery is installed inside of the unit. Do not expose the unit to excessive heat such as sunshine, fire or the like.

 indicates safety information.

AEEE Yönetmeliğine Uygundur
AEEE Complies with Directive of Turkey.

Read this first!

(For AW-HE42WE, AW-HE42KE) (continued)

EMC NOTICE FOR THE PURCHASER/USER OF THE APPARATUS

1. Pre-requisite conditions to achieving compliance with the above standards

<1> Peripheral equipment to be connected to the apparatus and special connecting cables

- The purchaser/user is urged to use only equipment which has been recommended by us as peripheral equipment to be connected to the apparatus.
- The purchaser/user is urged to use only the connecting cables described below.

<2> For the connecting cables, use shielded cables which suit the intended purpose of the apparatus.

- Video signal connecting cables
Use double shielded coaxial cables, which are designed for 75-ohm type high-frequency applications, for SDI (Serial Digital Interface).
Coaxial cables, which are designed for 75-ohm type high-frequency applications, are recommended for analog video signals.
- Audio signal connecting cables
If your apparatus supports AES/EBU serial digital audio signals, use cables designed for AES/EBU.
Use shielded cables, which provide quality performance for high-frequency transmission applications, for analog audio signals.
- Other connecting cables
Use double shielded cables, which provide quality performance for high-frequency applications, as connecting cables for IEEE1394 and USB.
- When connecting to the HDMI signal terminal, use multilayer shielded cables, which provide quality performance for high-frequency applications.
- If your apparatus is supplied with ferrite core(s), they must be attached on cable(s) following instructions in this manual.

2. Performance level

The performance level of the apparatus is equivalent to or better than the performance level required by these standards. However, the apparatus may be adversely affected by interference if it is being used in an EMC environment, such as an area where strong electromagnetic fields are generated (by the presence of signal transmission towers, cellular phones, etc.). In order to minimize the adverse effects of the interference on the apparatus in cases like this, it is recommended that the following steps be taken with the apparatus being affected and with its operating environment:



1. Place the apparatus at a distance from the source of the interference.
2. Change the direction of the apparatus.
3. Change the connection method used for the apparatus.
4. Connect the apparatus to another power outlet where the power is not shared by any other appliances.

Read this first!

(For AW-HE42WE, AW-HE42KE) (continued)

For the AC mains plug of three pins ■ Caution for AC mains lead

For your safety, please read the following text carefully.

This appliance is supplied with a moulded three pin mains plug for your safety and convenience. A 5-ampere fuse is fitted in this plug. Should the fuse need to be replaced please ensure that the replacement fuse has a rating of 5-ampere and that it is approved by ASTA or BSI to BS1362. Check for the ASTA mark  or the BSI mark  on the body of the fuse.

If the plug contains a removable fuse cover you must ensure that it is refitted when the fuse is replaced.

If you lose the fuse cover the plug must not be used until a replacement cover is obtained. A replacement fuse cover can be purchased from your local dealer.

Before use

Remove the connector cover.

How to replace the fuse

The location of the fuse differ according to the type of AC mains plug (figures A and B). Confirm the AC mains plug fitted and follow the instructions below. Illustrations may differ from actual AC mains plug.

1. Open the fuse cover with a screwdriver.

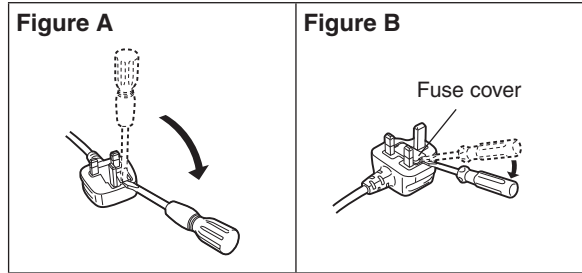

2. Replace the fuse and close or attach the fuse cover.

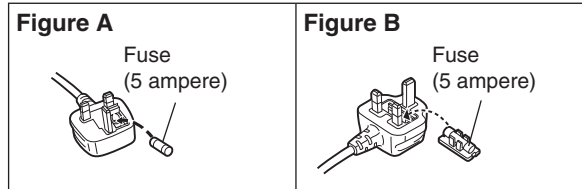

 indicates safety information.

Read this first!

(For AW-HE42WE, AW-HE42KE) (continued)



Disposal of Old Equipment and Batteries

Only for European Union and countries with recycling systems

These symbols on the products, packaging, and/or accompanying documents mean that used electrical and electronic products and batteries must not be mixed with general household waste.

For proper treatment, recovery and recycling of old products and used batteries, please take them to applicable collection points in accordance with your national legislation.

By disposing of them correctly, you will help to save valuable resources and prevent any potential negative effects on human health and the environment.

For more information about collection and recycling, please contact your local municipality.

Penalties may be applicable for incorrect disposal of this waste, in accordance with national legislation.

EU



Note for the battery symbol (bottom symbol):

This symbol might be used in combination with a chemical symbol. In this case it complies with the requirement set by the Directive for the chemical involved.

Back-up Battery (Lithium Battery)

For the removal of the battery for disposal at the end of its service life, please consult your dealer.

The symbols on this product (including the accessories) represent the following.

~ AC

== DC

□ Class II equipment (The construction of the product is double-insulated.)

Manufactured by: Panasonic Corporation, Osaka, Japan
Importer's name and address of pursuant to EU rules:
Panasonic Marketing Europe GmbH
Panasonic Testing Centre
Winsbergring 15, 22525 Hamburg, Germany

Contents

Read this first! (For AW-HE42WP, AW-HE42KP).....	2	Contrast 2/2 screen	48
Read this first! (For AW-HE42WE, AW-HE42KE).....	5	Picture 1/3 screen	50
Before use	10	Picture 2/3 screen	51
Overview	11	Picture 3/3 screen	52
Required personal computer environment	11	16-axis color matrix	53
Disclaimer of warranty	12	System screen	54
Network security	12	Genlock screen	54
Characteristics	13	Output screen	55
Accessories	15	Others 1/4 screen	58
Optional accessories	15	Others 2/4 screen	59
Operating precautions	16	Others 3/4 screen	60
Concerning the wireless remote control (optional accessory).....	18	Others 4/4 screen	61
Parts and their functions	19	Maintenance screen	62
Camera unit	19	Firmware Version screen	62
Wireless remote controller (optional accessory)	22	IP Network screen	63
Setting the remote control IDs	24	Camera menu item table	64
Network settings [When using Windows]	25	Displaying the web screen	67
Use the Easy IP Setup Software to establish the unit's settings	25	Displaying the web screen using a personal computer	67
Installing the plug-in viewer software	26	Switching between the Live screen [Live] and Web setup screen [Setup]	68
User authentication	27	Web screen operations	69
Basic shooting operations	28	Live screen [Live] : Single display mode	69
How to turn the power on and off	29	Live screen [Live] : Multi display mode	74
Turning the power on	29	Web screen configurations	75
Turning the power off	29	Logging into the Web setup screen [Setup]	75
Priority mode (Priority Mode)	30	Web setup screen [Setup]	76
Selecting the units	31	Basic screen [Basic]	77
Selecting the shooting modes (scene files)	31	Image screen [Image/Audio]	80
Types of shooting modes	31	Multi screen setup screen [Multi-screen]	100
How to select the shooting mode	32	User management screen [User mng.]	101
Shooting	33	Network setup screen [Network]	103
What to do when encountering problems in the basic shooting operations	34	Maintenance screen [Maintenance]	119
More advanced operations	35	Recording to and playing back from a memory card	124
Manual shooting	36	Web camera functions	128
Manually adjusting the focus	36	Controllable functions	128
Manually adjusting the iris	36	Displaying the web screen using a mobile terminal	131
Manually adjusting the shutter speed	37	Limiters	135
Manually adjusting the gain	37	Basic limiter operations	135
Preset memories	38	Setting the limiters	136
White balance adjustment	39	Releasing the limiters	136
White balance adjustment	39	Resetting the limiters	136
Black level (master pedestal) adjustment	43	Activation	137
Black level (master pedestal) adjustment	43	Troubleshooting	139
Basic setup operations	44	Specifications	151
Wireless remote control operations	44	Index	156
When performing the operations using the wireless remote control	44		
Camera menu items	45		
Setting the camera menu items	45		
Top Menu screen	45		
Camera screen (when Full Auto is selected)	46		
Camera screen (when Manual1 to 3 is selected)	47		
Contrast 1/2 screen	47		

Before use

Trademarks and registered trademarks

- Microsoft®, Windows®, Windows® 7, Windows® 8, Windows® 8.1, Internet Explorer® and ActiveX® are either registered trademarks or trademarks of Microsoft Corporation in the United States and other countries.
- Intel® and Intel® Core™ are trademarks or registered trademarks of Intel Corporation in the United States and other countries.
- Adobe® and Reader® are either registered trademarks or trademarks of Adobe Systems Incorporated in the United States and/or other countries.
- The terms HDMI and HDMI High-Definition Multimedia Interface, and the HDMI Logo are trademarks or registered trademarks of HDMI Licensing Administrator, Inc. in the United States and other countries.
- microSDXC Logo is a trademark of SD-3C, LLC.
- Apple, Mac, OS X, iPhone, iPod Touch, iPad, and Safari are registered trademarks of Apple Inc., in the United States and other countries.
- Android™ is a trademark of Google LLC.
- Other names of companies and products contained in these Operating Instructions may be trademarks or registered trademarks of their respective owners.

About copyright and licence

Distributing, copying, disassembling, reverse compiling, reverse engineering, and also exporting in violation of export laws of the software provided with the unit are expressly prohibited.

Abbreviations

The following abbreviations are used in this manual.

- Microsoft® Windows® 7 Professional SP1 32/64-bit is abbreviated to “Windows 7”.
- Microsoft® Windows® 8 Pro 32/64-bit is abbreviated to “Windows 8”.
- Microsoft® Windows® 8.1 Pro 32/64-bit is abbreviated to “Windows 8.1”.
- Windows® Internet Explorer® 8.0, Windows® Internet Explorer® 9.0, Windows® Internet Explorer® 10.0 and Windows® Internet Explorer® 11.0 are abbreviated to “Internet Explorer”.
- microSDHC memory cards and microSDXC memory cards are abbreviated to “SD cards”.

For the purposes of this manual, the model numbers of the units are given as listed in the table below.

Model number of unit	Model number given in manual
AW-HE42WP, AW-HE42KP, AW-HE42WE, AW-HE42KE	AW-HE42
AW-HS50N	AW-HS50
AW-HS50E	
AW-RP50N	AW-RP50
AW-RP50E	

Illustrations and screen displays featured in the manual

- What is shown in the manual's illustrations and screen displays may differ from how it is actually appears.
- The screenshots are used in accordance with the guidelines of Microsoft Corporation.
- Functions which can be used by Windows only are indicated using the  mark.

Before use (continued)

Overview

- The unit is a full HD camera integrated with a pan-tilt head and featuring a 1/2.3-type MOS sensor and digital signal processor (DSP).
- In addition to its optical 20x zoom lens, the unit comes with a 12x digital zoom allowing you to capture high-quality images that overflow with ambience. With built-in image stabilization, Night mode function, and ND filter, it can record in a wide range of environments. Further, its i.Zoom function allows up to 30x zoom while maintaining HD quality.
- This product is compatible with NDI|HX technology of NewTek, Inc.
- The unit supports transmission of video to NewTek NDI|HX compatible software applications and hardware devices over a network.
- When a controller is connected, camera operations can be performed smoothly via IP control or serial control.
- The unit features a Night mode, making it possible to shoot even under very-low-brightness conditions by exposing subjects to infrared rays.
- When the unit is connected to a computer via an IP network, it can be operated via a web browser while viewing the camera images on the screen.
- Connection with a Panasonic camera controller is also possible via Panasonic's proprietary serial communication format.
- The unit supports standard serial communication formats, allowing connection to commercially available controllers.
- The unit is available in two color variations (white or black) to suit your intended application and environment.
- Equipped with a codec engine, the unit can output Full HD images at up to 60 fps via a network.
- Changing the Priority Mode enables operation for various applications.

Required personal computer environment

CPU	When using 1080/60p [59.94Hz] and 1080/50p [50Hz] Intel® Core™ i7 3.4 GHz or higher recommended Other than above Intel® Core™2 Duo 2.4 GHz or higher recommended
Memory	For Windows: 1 GB or more (2 GB or more for Microsoft® Windows® 8.1, Microsoft® Windows® 8, Microsoft® Windows® 7 64-bit edition) For Mac: 2 GB or more
Network function	10BASE-T or 100BASE-TX port × 1
Image display function	Resolution: 1024 × 768 pixels or more Color generation: True Color 24-bit or more
Supported operating system and Web browser	Windows Microsoft® Windows® 8.1 Pro 64-bit/32-bit *1 Windows® Internet Explorer® 11.0 Microsoft® Windows® 8 Pro 64-bit/32-bit *1 Windows® Internet Explorer® 10.0 *1 Microsoft® Windows® 7 Professional SP1 64-bit/32-bit *2 Windows® Internet Explorer® 8.0 / 9.0 / 10.0 / 11.0 *3
	Mac OS X v10.8 Safari 6.2 OS X v10.9 Safari 7.1 OS X v10.10 Safari 8.0
	iPhone / iPad / iPod touch iOS 8.3 Standard browser
	Android Android OS 4.4 Standard browser
Other	Adobe® Reader® (for viewing the operating instructions available on the website)

*1: Use the desktop version of Internet Explorer. (Internet Explorer for Windows UI is not supported.)

*2: Windows® XP compatibility mode is not supported.

*3: The 64-bit version of Internet Explorer® is not supported.

IMPORTANT

- Failure to provide the required personal computer environment may slow down the delineation of the images on the screen, make it impossible for the web browser to work and cause other kinds of problems.

Memo

- Use the desktop version of Internet Explorer. (Internet Explorer for Windows UI is not supported.)
 - For the most recent information on compatible operating systems and web browsers, visit the support desk at the following web site.
<https://pro-av.panasonic.net/>
-

■ Disclaimer of warranty

IN NO EVENT SHALL Panasonic Corporation BE LIABLE TO ANY PARTY OR ANY PERSON, EXCEPT FOR REPLACEMENT OR REASONABLE MAINTENANCE OF THE PRODUCT, FOR THE CASES, INCLUDING BUT NOT LIMITED TO BELOW:

- ① ANY DAMAGE AND LOSS, INCLUDING WITHOUT LIMITATION, DIRECT OR INDIRECT, SPECIAL, CONSEQUENTIAL OR EXEMPLARY, ARISING OUT OF OR RELATING TO THE PRODUCT;
- ② PERSONAL INJURY OR ANY DAMAGE CAUSED BY INAPPROPRIATE USE OR NEGLIGENT OPERATION OF THE USER;
- ③ UNAUTHORIZED DISASSEMBLE, REPAIR OR MODIFICATION OF THE PRODUCT BY THE USER;
- ④ INCONVENIENCE OR ANY LOSS ARISING WHEN IMAGES ARE NOT DISPLAYED, DUE TO ANY REASON OR CAUSE INCLUDING ANY FAILURE OR PROBLEM OF THE PRODUCT;
- ⑤ ANY PROBLEM, CONSEQUENTIAL INCONVENIENCE, OR LOSS OR DAMAGE, ARISING OUT OF THE SYSTEM COMBINED BY THE DEVICES OF THIRD PARTY;
- ⑥ ANY DEMANDS FOR COMPENSATION, CLAIMS, ETC. OCCASIONED BY THE INFRINGEMENT OF PRIVACY BY INDIVIDUALS OR ORGANIZATIONS WHOSE IMAGES WERE SHOT BY THE USER BECAUSE THESE IMAGES (INCLUDING THE RECORDINGS MADE) WERE MADE AVAILABLE BY THE USER BECAUSE IN THE PUBLIC DOMAIN FOR SOME REASON OR OTHER OR BECAUSE THE IMAGES ENDED UP BEING USED FOR PURPOSES OTHER THAN THE ONE DESCRIBED ABOVE;
- ⑦ LOSS OF REGISTERED DATA CAUSED BY ANY FAILURE.
- ⑧ **Indemnity about recorded content**
Panasonic does not accept any responsibility for damages directly or indirectly due to any type of problems that result in loss of recording or edited content, and does not guarantee any content if recording or editing does not work properly. Likewise, the above also applies in a case where any type of repair is made to this unit.

■ Network security

As you will use the unit connected to a network, your attention is called to the following security risks.

- ① Leakage or theft of information through the unit
- ② Use of the unit for illegal operations by persons with malicious intent
- ③ Interference with or stoppage of the unit by persons with malicious intent

It is your responsibility to take precautions such as those described below to protect yourself against the above network security risks.

- Use the unit in a network secured by a firewall, etc.
- If the unit is connected to a network that includes personal computers, make sure that the system is not infected by computer viruses or other malicious entities (using a regularly updated antivirus program, anti-spyware program, etc.).
- Protect your network against unauthorized access by restricting users to those who log in with an authorized user name and password.
- After accessing the unit as an administrator, be sure to close all web browsers.
- Change the administrator password periodically.
- Restrict access to the unit by authenticating the users, for example, to prevent setting information stored on the unit from leaking over the network.
- Do not install the camera in locations where the camera or the cables can be destroyed or damaged by persons with malicious intent.
- Avoid connections that use public lines.

Memo

Concerning user authorization

User authentication on the unit can be performed via digest authentication or basic authentication. If basic authentication is used without using a dedicated line equipped with an authentication function, password leaks may occur.

Usage restrictions

Use of the same segment is recommended for the network in which the unit and the controller or personal computer are connected.

If the equipment uses connections with different segments, events based on the settings inherent to the network equipment, for instance, may occur so check this thoroughly prior to operation.

Characteristics

Multiple number of formats supported

- You can switch between the following formats via the camera menus or a web browser.

Supported formats:

1080/59.94p, 1080/59.94i, 1080/29.97p, 1080/29.97PsF, 720/59.94p, 1080/50p, 1080/50i, 1080/25p, 1080/25PsF, 720/50p

1/2.3-type MOS sensor and high-performance 20× zoom lens featured

- A 1/2.3-type MOS sensor and DSP (digital signal processor) are incorporated. High-quality pictures are obtained by video processing in many different kinds of ways.
- In addition to its optical 20× zoom lens, the unit comes with a 12× digital zoom to achieve high-quality images that overflow with ambiance. Further, its i.Zoom function allows up to 30× zoom while maintaining HD quality.
- The unit is equipped with functions that allow clean and clear reproduction of images in a wide range of applications, such as high dynamic range (HDR) and dynamic range stretch (DRS) functions that compensate for overexposure and loss of dark detail and a digital noise reduction (DNR) function that allows you to shoot scenes clearly by minimizing image lag even in dark locations.

Easy operation of unit enabled by its integration with a high-performance pan-tilt head unit

- High-speed operations with maximum speed of 300°/s during preset, and 90°/s during manual
- Wide rotational angles with a panning range of ±175° and a tilting range from -30° to +90°
- Quiet operation with noise levels of NC35 (normal speed) and NC40 (during preset)
- Storage of up to 100 positions in the preset memory (The number of preset memories that can be used varies from one controller to another.)

Night mode incorporated

- Infrared shooting is supported. The kind of shooting which is normally difficult under very-low-brightness conditions is now possible by exposing the subjects to infrared rays. (Black-and-white images are output in this case.)
- The iris will be fixed at open.

IP video output function featured

- The unit is equipped with image compression and IP transmission LSI capabilities. IP video transmission in SD format is possible. In addition, output at up to 60 fps is possible for Full HD images.
- Employing the functions of this chip together with IP control opens the door to uses in a wide range of applications including the control of the camera from a remote location.

High degree of compatibility with Panasonic's currently available controllers, enabling a flexible system to be put together

- A maximum of five units can be operated by serial control from one of Panasonic's currently available controllers (AW-RP50). The unit can also be used together with the cameras and pan-tilt head unit systems currently available from Panasonic Corporation so that an existing system can be used to advantage to put together a system that is even more flexible.

Notes

- It may be necessary to upgrade the version of the controllers in order to support the unit. For details on upgrading, visit the support page on the following website.
<https://pro-av.panasonic.net/>
- The maximum distances between the units and controller is 1000 meters (3280 ft). (when serial control is exercised)
Use of an external device or some other means must be provided separately in order to extend the video signal connections.

Standard serial communication support

- Connect up to seven cameras to a commercially available controller via RS-232C interface.

Integrated pan-tilt head unit, camera and lens to facilitate installation

- By designing the camera, lens and pan-tilt head as a single integrated unit, the time taken for the installation work has been drastically reduced.

Use of easy-to-operate wireless remote control (optional accessory) is possible

- A wireless remote control capable of operating up to four units can be used. It can easily be used to set the various functions or switch between them while viewing the menu screens.

Characteristics (continued)

Flexible camera layout enabled by simple connection and installation

- The unit features excellent connectivity and installability thanks to the IP control; a lightweight main unit, and the turn-lock mechanism, which enables the user to install it on his or her own (only when used indoors).

Note

- Bear in mind that the unit is designed to be used indoors only: It cannot be used outdoors.

Easy connections and settings courtesy of IP control

- Up to a hundred units can be operated by IP connection from a Panasonic controller (AW-RP50).
(The maximum length of the LAN cables is 100 meters [328 ft].)
- By automatically recognizing the IP addresses and changing their allocation, the previous restrictions on the connections between the cameras and controllers using serial interfaces and the time and trouble taken to establish the various settings can be significantly reduced, and by configuring a network, flexible camera control can be implemented anywhere with any of the cameras.

PoE+ *1 eliminates need for camera power configurations

- Configurations for camera's power supply are not necessary when the unit is connected to a network device that supports the PoE+ standard (IEEE802.3at compliant)*2.

Notes

- If the AC adaptor and a PoE+ power supply are connected simultaneously, the AC adaptor will have priority.
- Use a category 5e cable or higher when using a PoE+ power supply.
The maximum length of the cable between the power supply unit and the unit is 100 meters (328 ft).
Using a cable that is lower than category 5e may result in reduced power supply capabilities.

*1: Power over Ethernet Plus.

Referred to as "PoE+" in this manual.

*2: For details on PoE+ power supply devices for which operation has been verified, consult your local dealer.

Equipped with a high dynamic range (HDR) imaging function

- This reduces overexposure and loss of dark detail in images with high light-dark contrast between the background and the subject.

Built-in ND filter

- Built-in ND filter with 4 positions (Through, 1/4, 1/16, 1/64). This makes it easy to select the most suitable shutter speed and aperture under varying levels of illumination.

When "Full Auto" is selected as the setting for shooting mode (Scene), you can select ND filter auto selection function according to ambient light conditions.







Equipped with optical image stabilization (OIS)

- This function detects and compensates for camera shake to reduce image blurring due to camera jitter. High-precision camera shake compensation is provided through an optical image stabilization with low image degradation.

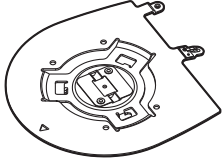
Accessories

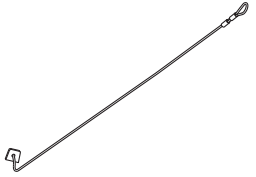
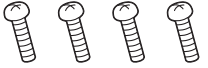
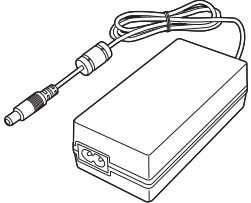
Check that the following accessories are present and accounted for.

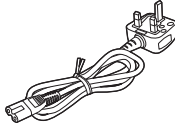
- After removing the product from its container, dispose of the power cable cap and packing materials in an appropriate manner.

<p>■ Mount bracket for installation surface (Hanging / Desktop)..... 1</p> 	<p>■ Main unit mounting screw (with flat washer, spring washer) M3 x 6 mm..... 1</p> 	<p>■ Drop-prevention wire..... 1 (already attached to the unit)</p> 	<p>■ Bracket mounting screws (bind-head) M4 x 10 mm..... 4</p> 
<p>■ AC adaptor 1</p> 	<p>■ Power cable for AW-HE42WP, AW-HE42KP 1</p>  <p>for AW-HE42WE, AW-HE42KE 3</p> <ul style="list-style-type: none"> • For U.K. and Saudi Arabia • For India only • For Continental Europe, etc.   <p>• This product is equipped with 3 types of AC mains cable. Appropriate mains cable must be used in each local area, since the other type of mains cable is not suitable.</p>		

Optional accessories

- Wireless remote controller AW-RM50G (Size “AA”, “R6” or “LR6” dry battery x 2, obtained separately)
- Direct ceiling mount bracket WV-Q105A

Operating precautions

Shoot under the proper lighting conditions.

To produce pictures with eye-pleasing colors, shoot under the proper lighting conditions.

The pictures may not appear with their proper colors when shooting under fluorescent lights. Select the proper lighting as required.

To ensure a stable performance in the long term

Using the unit for prolonged periods in locations where the temperature and humidity levels are high will cause its parts to deteriorate, resulting in a reduction of its service life. (Recommended temperature: Max. 35 °C [95 °F]) Ensure that a cooling unit or heating unit will not blow any air directly toward the installation location.

Image persistence on the MOS sensor color filters

If parts of the MOS sensor are exposed continuously to spotlights or other bright lights, the color filters inside the MOS sensor will deteriorate, and the parts concerned may become discolored. The discoloration may be noticeable when the direction of fixed monitoring is changed.

Do not point the camera at strong lights.

When parts of the MOS sensor are exposed to spotlights or other strong lights, blooming (a phenomenon where the edges of strong lights become blurred) may occur.

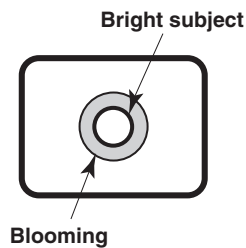

Concerning the color reproduction of MOS sensors

Depending on the color tones of the subjects, the color reproduction may deteriorate: This is normal and not indicative of any trouble.

What happens with high-brightness subjects

Flare may occur if an extremely bright light source is pointed at the lens. In a case like this, change the angle or take some other remedial action.

When using the automatic functions

- If "Full Auto" has been selected as the setting for Scene on the camera menu, for example, all the auto settings will be turned on, and manual operations will no longer be possible for some of the items.
- When using the ATW (auto tracking white adjustment) function under fluorescent lights, the white balance may vary.
- In some situations, it may be hard to focus at the auto setting. In cases like this, select the manual setting, and focus manually.
- The appropriate brightness may not be obtained when shooting bright objects using the auto settings for the gain and iris. In cases like this, set the shutter speed to manual, and adjust.

Zooming and focusing

When the focus is set manually, out-of-focusing may occur during zooming.

After zooming, if necessary, either adjust the focus or set the focus to auto.

When using the focus at the manual setting, proceed with zooming after setting the focus position at the Tele end where the focusing accuracy is higher.

(However, if the distance from the unit to the subject is less than 1.0 meter [3.28 ft], the subject may shift out of focus at the Wide end.)

If zooming is performed to the Tele end after having adjusted the focus at the Wide end, out-of-focusing may occur.

Concerning the zoom position when the power is turned on

When the unit is turned on, the zoom, focus, and iris return to their positions from before the unit entered standby mode. (This happens for the focus and iris when they were set manually.)

The operation will be performed with the [Preset Scope] settings applied in such cases.

However, this position may not be restored if, for instance, the power cable was disconnected during operation.

Operating temperature range

Avoid using the unit in cold locations where the temperature drops below 0 °C (32 °F) or hot locations where the temperature rises above 40 °C (104 °F) since these temperatures downgrade the picture quality and adversely affect the internal parts.

Concerning the HDMI interface standard

The unit has been certified as HDMI-compatible, but on rare occasions images may not be displayed depending on the HDMI device which has been connected to the unit.

Operating precautions (continued)

Color bars

Color bars are used to adjust the color phase, and the widths and positions of these bars may differ from other models.

Concerning IP video refresh speed and operations from the web screen

The IP video refresh speed may be reduced and operations from the web screen may be slower, depending on the network environment used, performance of the personal computer or the mobile terminal, subjects and access count.

H.264 patent pool licensing

This product is licensed based on the AVC Patent Portfolio License, and the license does not extend beyond uses by users, who engage in the acts described below, for their own personal and non-profit applications.

- (i) Recording of image information in compliance with the AVC standard (hereafter, "AVC videos")
- (ii) Playing of AVC videos recorded by consumers engaging in personal activities or AVC videos acquired from licensed providers

For details, visit MPEG LA, LLC website (<http://www.mpegla.com>).

Concerning PoE+ power supply

The unit complies with the IEEE802.3at standard.

Use a PoE+ compatible Ethernet hub and injector when using a PoE+ power supply.

For details on recommended Ethernet hubs and injectors, consult your local dealer.

Turn off the power before connecting or disconnecting the cables.

Always disconnect the power supply before connecting or disconnecting cables.

Handle the unit carefully.

Do not drop the unit or subject it to strong impact or vibration. Doing so may cause the unit to malfunction.

When the unit is not in use

Turn off the unit's power when it is not in use.

When the unit is no longer going to be used, do not leave it lying around, but be absolutely sure to remove it properly.

Do not touch the optical system parts.

The optical system parts are the very heart of the camera. Under no circumstances must they be touched.

In the unlikely event that they have become dusty, remove the dust by using a camera blower or by wiping them gently with a lens cleaning paper.

Do not point the camera directly at the sun or a laser beam no matter whether it is turned on or not.

Taking images of the sun, laser beams, or other brightly lit subjects for prolonged periods of time may damage the MOS sensor.

Personal computer used

If the same image is displayed for a prolonged period on a PC monitor, the monitor may be damaged. Use of a screen saver is recommended.

Concerning the IP address setting

Do not run the Easy IP Setup Software on a multiple number of personal computers for a single camera and set the IP address at the same time.

Otherwise, you will be unable to complete the proper procedure and set the IP address correctly.

Do not allow foreign matter to make contact with the rotating parts.

Otherwise, trouble may be caused.

Keep the unit away from water.

Avoid all direct contact with water. Otherwise, problems may occur.

Maintenance

Disconnect the power supply before proceeding with maintenance.

Otherwise, you may injure yourself.

Wipe the surfaces using a soft dry cloth. Avoid all contact with benzine, paint thinners and other volatile substances, and avoid using these substances. Otherwise, the casing may become discolored.

Do not turn the camera head by hand.

Turning the camera head by hand may cause the unit to malfunction.

Use the unit in an environment with minimal moisture and dust.

Avoid using the unit in an environment with high concentration of moisture or dust since these conditions will damage the internal parts.

Disposal of the unit

When the unit has reached the end of its service life and is to be disposed of, ask a qualified contractor to dispose of the unit properly in order to protect the environment.

Concerning the wireless remote control (optional accessory)

The unit can be operated by remote control using a wireless remote control (model number: AW-RM50G) purchased separately.

Check out the following points before using the wireless remote control.

- Point the wireless remote control at the unit's wireless remote control signal light-sensing area (front panel or side panel), and operate it within a range of 10 meters (32.8 ft) from these areas.
Refer to <Layout of wireless remote control signal light-sensing areas> shown below.

- If the unit is installed near fluorescent lights, plasma monitors or other such products or if the unit is exposed to sunlight, the effects of the light may make it impossible for the unit to be operated using the wireless remote control.

Be sure to follow the steps below for installation and use.

- Take steps to ensure that the wireless remote control signal light-sensing area will not be exposed to the light from fluorescent lights, plasma monitors or other such products or from the sun.
- Install the unit away from fluorescent lights, plasma monitors and other such products.
- For about 10 minutes even after the batteries have been removed from the wireless remote control, the selection of the operation to be performed (the [CAM1], [CAM2], [CAM3] or [CAM4] button which was pressed last) will remain stored in the memory. When a longer period of time elapses, however, the selection is reset to the status established when the [CAM1] button was pressed.

<Layout of wireless remote control signal light-sensing areas>

Note

- The arrows in the figure below show the light-sensing directions in which the wireless remote control signals travel.

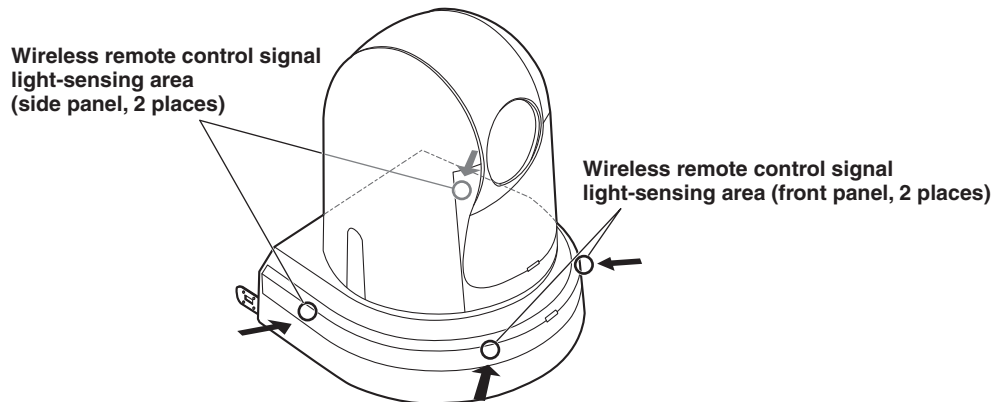

- Top view

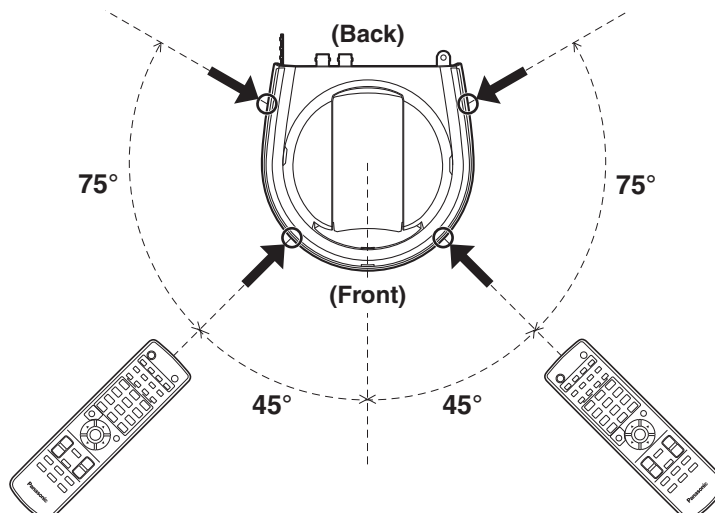

Parts and their functions

■ Camera unit

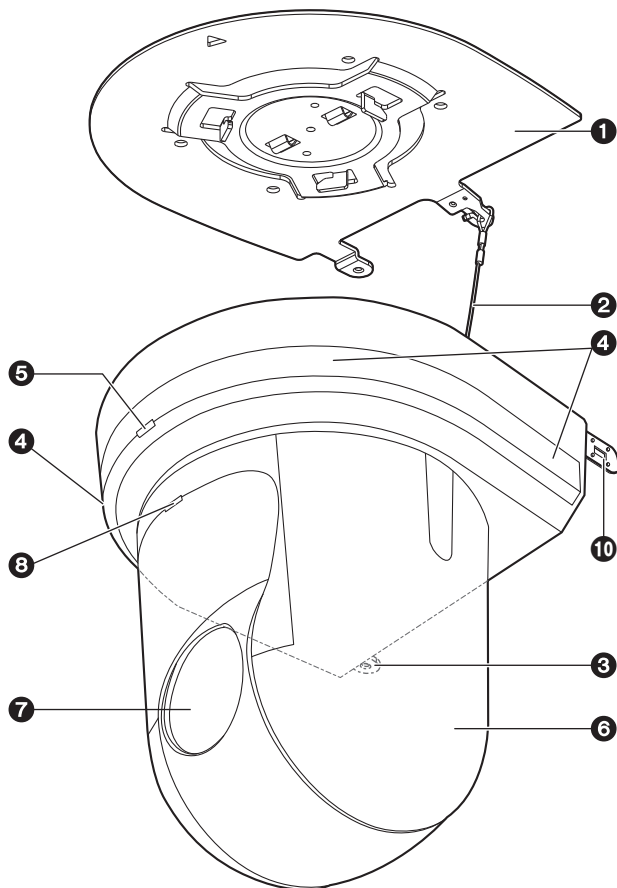

<Rear panel>

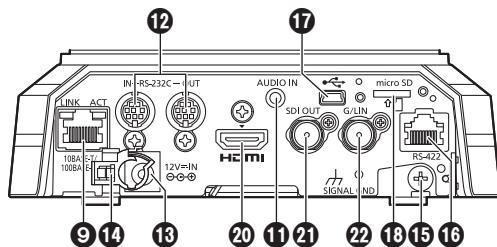

<Bottom panel>

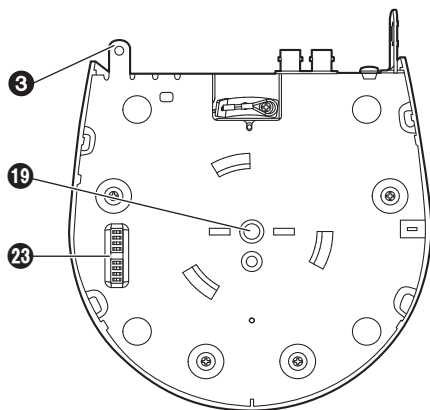

① Mount bracket for installation surface (supplied accessory)

Mount this bracket onto the installation surface, and then attach the camera main unit to the bracket.

② Drop-prevention wire

Pull out the wire from the bottom panel of the camera main unit, and attach it to the hook of the mount bracket.

③ Hole for securing the camera pedestal

This hole is provided in the bottom panel of the camera pedestal.

④ Wireless remote control signal light-sensing area

Light sensors are located in four places; at the front of the camera pedestal and on either side.

⑤ Status display lamp

This lights in the following way depending on the status of the unit.

Orange: When the standby status is established

Green: When the power is on

Red: When trouble has occurred in the unit

Green and blinks twice:

When a signal matched by the remote control ID has been received from the wireless remote control (optional accessory) while the power is on

Orange and blinks twice:

When a signal which is not matched by the remote control ID has been received from the wireless remote control (optional accessory) while the power is on

⑥ Camera head

This rotates in the horizontal direction.

⑦ Lens unit

This rotates in the up and down direction.

⑧ Tally lamp

This comes on or goes off in response to the control from the controller but only when "On" has been selected as the tally lamp use setting.

Parts and their functions (continued)

9 LAN connector for IP control [LINK/ACT]

This LAN connector (RJ-45) is connected when exercising IP control over the unit from an external device. Use a cable with the following specifications for the connection to the LAN connector:

When connecting through a hub:

LAN cable* (category 5 or above), max. 100 meters [328 ft]

When using a PoE+ compatible hub:

LAN cable* (category 5e or above), max. 100 meters [328 ft]

When a hub is not used:

LAN cable* (category 5 or above), max. 100 meters [328 ft]

*: Use of an STP (shielded twisted pair) cable is recommended.

16 RS-422 connector [RS-422]

This RS-422 connector (RJ-45) is connected when exercising serial control over the unit from an external device.

Use a cable with the following specifications for the connection to this connector.

The tally lamp can be lit by shorting the TALLY signal (pin 2) with GND (pin 1).

Note

- Do not apply a voltage to the TALLY signal pin.

LAN cable* (category 5 or above, straight cable), max. 1000 meters [3280 ft]

*: Use of an STP (shielded twisted pair) cable is recommended.

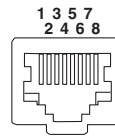

Pin No.	Signal	Pin No.	Signal
1	GND	5	TXD +
2	TALLY	6	RXD +
3	RXD -	7	—
4	TXD -	8	—

10 Anti-theft wire mounting hole

Use this hole to attach the wire bracket (commercially available).

11 Audio input connector [AUDIO IN]

Inputs external audio (microphone, line).

12 RS-232C connectors [RS-232C IN/OUT]

Connect to RS-232C cables.

RS-232C IN/OUT connector

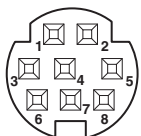

• Mini DIN 8-pin (JST)

RS-232C IN		RS-232C OUT	
Pin No.	Signal	Pin No.	Signal
1	DTR_IN	1	DTR_OUT
2	DSR_IN	2	DSR_OUT
3	TXD_IN	3	TXD_OUT
4	GND	4	GND
5	RXD_IN	5	RXD_OUT
6	GND	6	GND
7	IR OUT R	7	NC
8	IR OUT L	8	NC

Note

- Be aware that the polarities (+/-) of the serial data may be different depending on the specifications of the device to be connected.

13 DC IN connector [12V $\overline{=}$ IN \ominus \oplus]

Connect the AC adaptor supplied with the unit to this connector to supply the DC 12 V voltage to the unit.

14 Cable clamp

This is used to hold the cable connection to the DC IN connector and prevent it from becoming disconnected.

15 Ground connector

Connects to the ground connector on a wall outlet, ground bar, etc. for grounding. (Installation Instructions → "Connections" → "Note on grounding")

17 USB port

The unit can be used as a Web camera by connecting the unit and a personal computer with USB Video Class.

18 microSD card slot

The video and audio of the camera can be recorded to a microSD card in MP4 format.

19 Threaded hole (thread: 1/4-20UNC, ISO1222 [6.35 mm]) for mounting the camera

Use this hole when mounting the camera on a tripod, etc.

20 HDMI connector [HDMI]

This is the HDMI video signal output connector.

For limitations that pertain when simultaneously outputting HDMI and SDI signals, refer to page 55.

21 SDI OUT connector [SDI OUT]

This is the SDI video signal output connector.

For limitations that pertain when simultaneously outputting HDMI and SDI signals, refer to page 55.

Parts and their functions (continued)

22 G/L IN connector [G/L IN]

This is the external sync signal input connector.

This unit supports BBS (Black Burst Sync) and tri-level synchronization.

External synchronization (genlock) can be applied to achieve phase alignment when multiple cameras are to be used or when the unit is to be used in combination with other devices.

Supply to this connector the sync signals that correspond to the video signal format which has been set.

Format	External sync signal input format	
	BBS	Tri-level sync
1080/59.94p	480/59.94i	1080/59.94i
1080/29.97p	480/59.94i	—
1080/59.94i	480/59.94i	1080/59.94i
1080/29.97PsF	480/59.94i	1080/59.94i
720/59.94p	480/59.94i	720/59.94p
1080/50p	576/50i	1080/50i
1080/25p	576/50i	—
1080/50i	576/50i	1080/50i
1080/25PsF	576/50i	1080/50i
720/50p	576/50i	720/50p

- External synchronization is performed using the SDI video signal. Synchronization is not possible using the HDMI video signal or the IP video signal.
For horizontal phase adjustment, refer to “Genlock screen” (page 54).

23 Service switches

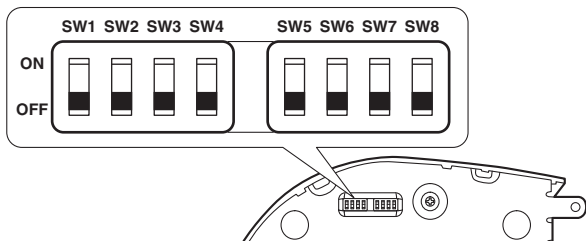

Function	OFF	ON	Factory setting
SW1	See descriptions for SW1 to SW3		OFF
SW2			OFF
SW3			OFF
SW4	Panasonic proprietary serial communication	Standard serial communication	OFF
SW5	Always leave at OFF (used for factory adjustments)		OFF
SW6	Disable	Enable	OFF
SW7	9600 bps	38400 bps	OFF
SW8	RS-422	RS-232C	OFF

Notes

- Perform switch settings before turning the unit on.
- Cameras whose camera address setting switches are set to AUTO cannot coexist with cameras whose switches are set to 1 to 7.
- Manually setting multiple cameras to the same address will not allow you to control multiple cameras from a single controller simultaneously.

Service switch settings

- SW1 to SW3: Camera address setting switches
Configure the camera address.
Set this to AUTO under normal circumstances. When cameras are set to AUTO, addresses will be assigned to the cameras automatically in response operation from the controller in the order in which the cameras were connected.
To manually configure the address, set the switches as follows.

Address	AUTO	1	2	3	4	5	6	7
SW1	OFF	ON	OFF	ON	OFF	ON	OFF	ON
SW2	OFF	ON	ON	OFF	OFF	ON	ON	OFF
SW3	OFF	ON	ON	ON	ON	OFF	OFF	OFF
- SW4: Communication format selection switch
Selects the communication format.
When this is set to ON, standard serial communication is enabled.
When this is set to OFF, Panasonic’s proprietary serial communication is enabled.
- SW5: Maintenance switch
Fixed at OFF.
Do not change this switch setting.
- SW6: Infrared output switch
When this is set to ON, infrared output is enabled. The signal received via the remote control sensor is output from pins 7 and 8 of the RS-232C IN connector.
Signal output is disabled when this is set to OFF.
- SW7: Communication baud rate switch
When this is set to ON, the baud rate is 38400 bps.
When this is set to OFF, the baud rate is 9600 bps.
- SW8: Communication connector switch
When this is set to ON, RS-232C is enabled.
When this is set to OFF, RS-422 is enabled.

Parts and their functions (continued)

■ Wireless remote controller (optional accessory)

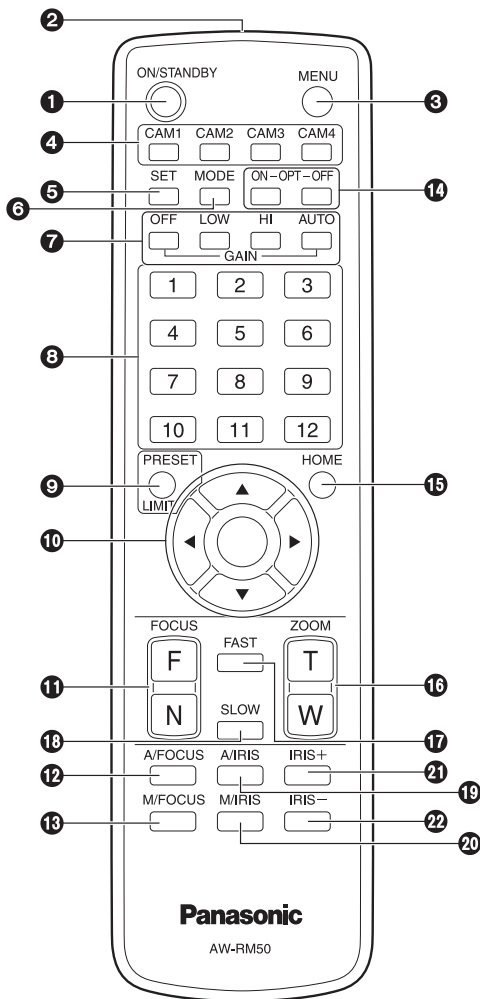

1 ON/STANDBY button

Each time this is pressed for 2 seconds, operation switches between turning on the unit's power and establishing the standby status.

Notes

- When operation is transferred to the standby mode: The current pan-tilt position is stored in the memory (as a POWER ON preset), and the panning/tilting moves so that the camera points in the backward-facing direction.
- When operation is transferred to the POWER ON mode: Panning/tilting moves to the position which was stored in the memory (as a POWER ON preset) when operation was transferred to the standby mode.

2 Signal transmission window

3 MENU button

Each time this is pressed for 2 seconds, operation switches between displaying the unit's camera menu and exiting the camera menu.

When it is pressed quickly (for less than 2 seconds) while a menu is displayed, the setting change is canceled. Furthermore, the pan and tilt movement range limits (limiters) are set and released by operating the MENU button, PRESET/LIMIT button and the pan-tilt buttons ([▲], [▼], [◀] and [▶]).

For details, refer to "Limiters" (page 135).

4 CAM1 to CAM4 buttons

These are used to select the units that are to be operated. Once a button has been selected, the unit corresponding to the selected button can be operated.

5 SET button

If this button is pressed when one of the "Manual1 to 3" settings has been selected for "Scene" on the camera menu and the AWB A memory or AWB B memory has been selected by the white balance adjustment, the white balance is automatically adjusted and registered in the selected memory.

6 MODE button

This is used to select the video signals which are output from the unit.

Each time it is pressed, the signals are switched between the color bar signals and camera video signals.

Note

- When the color bar is displayed, a test tone (1 kHz) is output according to the Audio setting in the camera menu. Be cautious of the volume on external devices.

7 GAIN buttons [OFF] [LOW] [HI] [AUTO]

These are used to set the gain.

The gain increase can be set in three steps using the [OFF], [LOW] and [HI] buttons.

[OFF] is set to 0 dB, [LOW] is set to 9 dB, and [HI] is set to 18 dB.

When the [AUTO] button is pressed, the AGC function is activated, and the gain is adjusted automatically depending on the light quantity.

The maximum gain of the AGC function can be set using the camera menu.

8 Preset memory call buttons [1] to [12]

These are used to call the information on the unit's directions and other settings, which have been registered in the unit's preset memories No.1 to No.12, and reproduce those settings.

Settings in preset memories No.13 and above cannot be called from the wireless remote control.

Parts and their functions (continued)

9 PRESET/LIMIT button

This is used to register the settings in the preset memories or set or release the limiters.

When a preset memory call button is pressed while the PRESET/LIMIT button is held down, the information on the unit's current direction and other settings is registered in the call button.

Preset memory call buttons [1] to [12] correspond to the unit's No.1 to No.12 preset memories.

Furthermore, the pan and tilt movement range limits (limiters) are set and released by operating the PRESET/LIMIT button, MENU button and the pan/tilt buttons ([▲], [▼], [◀] and [▶]).

For details, refer to "Limiters" (page 135).

10 Pan-tilt buttons and menu operation buttons

[▲] [▼] [◀] [▶] [○]

(1) These are used to change the unit's direction.

The unit is tilted in the up/down direction using the [▲] and [▼] buttons and panned in the left/right direction using the [◀] and [▶] buttons.

The [○] button does not work during tilting and panning.

When the [▲] or [▼] and [◀] or [▶] buttons are pressedd at the same time, the unit moves diagonally.

(2) The buttons are used for menu operations when the unit displays the camera menus.

Use the [▲], [▼], [◀] and [▶] buttons to select the menu items.

When a selected item has a sub-menu, the sub-menu will be displayed by pressing the [○] button.

When the cursor is aligned with a particular item and the [○] button is pressed on the setting menu at the bottom hierarchical level, the setting of the selected item blinks.

When the [○] button is pressed after the setting has been changed using the [▲], [▼], [◀] and [▶] buttons, the setting stops blinking, and the new setting is entered.

With a regular menu, the new setting is reflected immediately after it has been changed if the change was made from the setting in the blinking status, but there are some menus (Scene, Format and Initialize) where it is reflected only after the [○] button has been pressed, the blinking has stopped and the new setting has been entered.

If the MENU button is pressed quickly (for less than 2 seconds) while the setting is in the blinking status, the change will be canceled, and the setting selected prior to the change will be restored.

11 FOCUS buttons [F] [N]

These are used to adjust the lens focus manually when the manual setting is established for the lens focus.

The focus is adjusted in the far using the [F] button and in the near using the [N] button.

12 A/FOCUS button

This is used when automatically adjusting the lens focus.

13 M/FOCUS button

This is used when manually adjusting the lens focus. The FOCUS buttons ([F] and [N]) are used when performing the actual adjustment.

14 OPT buttons [ON] [OFF]

This is used to select the Day mode or Night mode.

[ON]: Night mode

[OFF]: Day mode (standard setting)

15 HOME button

When this is pressed for 2 seconds, the unit's direction (panning or tilting) returns to the reference position.

16 ZOOM buttons [T] [W]

These are used to adjust the lens zoom.

The zoom is adjusted in the wide-angle using the [W] button and in the telephoto using the [T] button.

17 FAST button

This is used to change the movement speed at which the panning, tilting, zooming and focusing operations are performed to the high speed.

When the button is tapped, the movement speed can be set to the normal high-speed operation. When the button is held down, it can be set to an even faster high-speed operation. Tap the button to return the movement speed to the normal high-speed operation.

Note

- The operating speed for panning and tilting when the preset memory settings have been called can be changed using the Preset Speed item and Preset Speed Table item of the camera menu.

18 SLOW button

This is used to change the movement speed at which the panning, tilting, zooming and focusing operations are performed to the low speed.

When the button is tapped, the movement speed can be set to the normal low-speed operation. When the button is held down, it can be set to an even slower low-speed operation. Tap the button to return the movement speed to the normal low-speed operation.

19 A/IRIS button

This establishes the setting for adjusting the lens iris automatically in line with the light quantity.

20 M/IRIS button

This establishes the setting for adjusting the lens iris manually.

The IRIS + and IRIS – buttons are used when performing the actual adjustment.

21 IRIS + button

This is used to adjust the lens iris in the opening direction.

22 IRIS – button

This is used to adjust the lens iris in the closing direction.

Setting the remote control IDs

The wireless remote control (optional accessory) is capable of operating up to four units.

IDs are used to set which units are selected when the [CAM1], [CAM2], [CAM3] and [CAM4] buttons on the wireless remote control have been pressed.

- When operating a multiple number of these units using wireless remote controls, set a different remote control ID for each control.
- When using one unit, set the remote control ID to “CAM1” unless the setting needs to be changed.

Setting procedure

Operate the unit's camera menu or the web screen to select a remote control ID ([CAM1] to [CAM4]).

The camera's [CAM1] to [CAM4] settings correspond to the [CAM1] to [CAM4] buttons on the wireless remote control. (The factory setting is “CAM1”.)

For details, refer to “IR ID” (page 60, page 99).

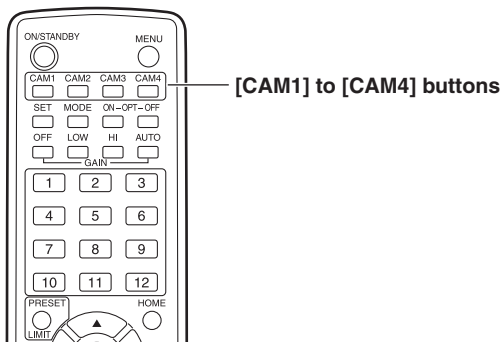

Network settings [When using Windows]

■ Use the Easy IP Setup Software to establish the unit's settings

The settings related to the unit's network can be established using the Easy IP Setup Software supplied.

You can obtain Easy IP Setup Software (EasyIPSetup.exe) by downloading it from the following website.

<https://pro-av.panasonic.net/>

To establish the settings for a multiple number of units, the settings must be selected for each camera involved. If the settings cannot be established using the Easy IP Setup Software, select the settings separately for the unit and personal computer on the Network setup screen [Network] of the setting menu. (page 103)

Notes

- If, after the network settings have been established, another device in the same network has the same IP address, the network operations will not be performed properly.
Set the IP address in such a way that it does not duplicate an existing IP address.
- Do not establish network settings from a multiple number of Easy IP Setup Software programs at the same time for a single camera.
Similarly, do not perform the "Auto IP setting" operation of the remote camera controller (AW-RP50) at the same time.
The IP address settings may no longer be recognized as a result.
- When you start the Easy IP Setup Software, you may be asked for the administrator account password.
- To enhance security, the Easy IP Setup Software is designed so that when around 20 or more minutes have passed after the power was turned on, the network settings of the target camera can no longer be configured. (When the [Easy IP Setup accommodate period] setting is [20min] → page 105)
- The Easy IP Setup Software cannot be used from a different subnet via a router.

1 Start the Easy IP Setup Software.

2 Click the [Search] button.

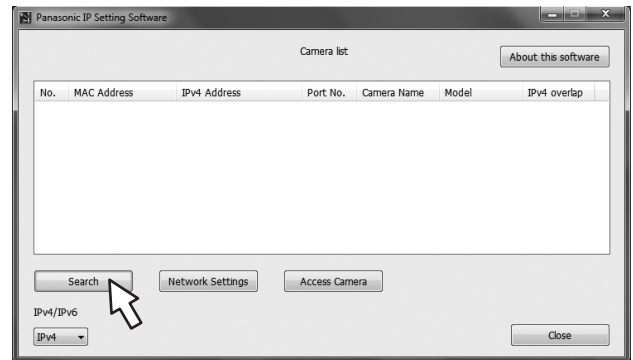

3 Click the MAC address/IPv4 address of the camera to be set, and click the [Network Settings] button.

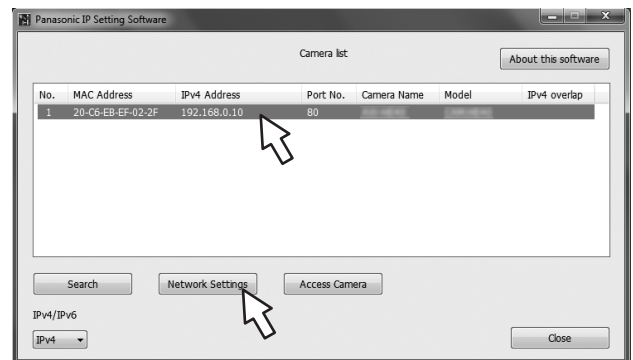

Notes

- When a DHCP server is being used, the IP address allocated to the unit can be checked by clicking the [Search] button of the Easy IP Setup Software.
- If the same IP address is used for any additional cameras, the numbers of the additional cameras will be displayed in the "IPv4 overlap" column of the cameras concerned.
- When the [Access Camera] button is clicked, the Live screen of the selected camera is displayed.

Network settings [When using Windows] (continued)

- 4 Input the network items, and click the [Save] button.

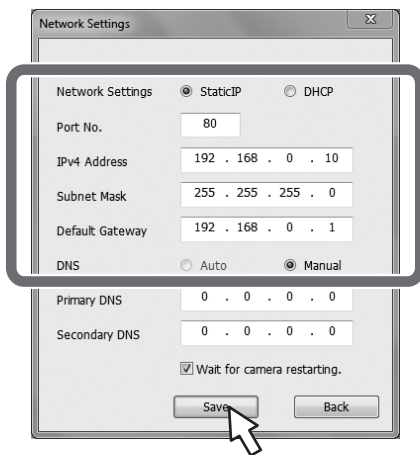

Notes

- When a DHCP server is being used, “DNS” of the Easy IP Setup Software can be set to “Auto”.
- After the [Save] button is clicked, it takes about 1 minute for the settings in the unit to be completed. If the AC adaptor or LAN cable is disconnected before the settings are completed, the settings will be canceled. In this case, repeat the steps to establish the settings.
- When a firewall (including software) has been introduced, enable access to all the UDP ports.
- When the Easy IP Setup Software is used for the first time, the [Program Compatibility Assistant] screen may appear after quitting the Easy IP Setup Software. Select [This program installed correctly] in the [Program Compatibility Assistant] screen.

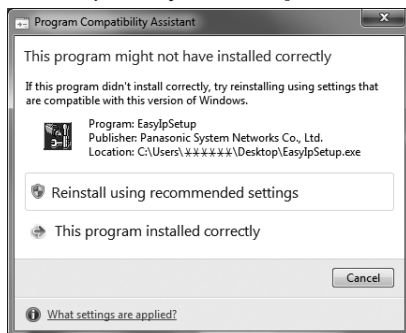

■ Installing the plug-in viewer software

To view IP images from the unit on a web browser, the “Network Camera View 4S” plug-in viewer software (ActiveX®) must be installed in your personal computer.

- When you display the Live screen [Live] on the personal computer for the first time, the installation screen for the plug-in viewer software (ActiveX) appears. Follow the instructions on the screen to perform installation.
- Depending on the operating environment of your computer, you may need to start Internet Explorer with an administrator account during installation. (Startup with an administrator account will not be required after installation is complete.)



Notes

- [Automatic installation of viewer software] is set to [On] at the time of purchase, allowing you to install directly from the unit. If a message appears in the web browser's information bar, refer to page 150.
- If the plug-in viewer software (ActiveX) installation screen continues to appear when switching screens, even after it is installed, restart the personal computer.
- To uninstall the plug-in viewer software, select [Control Panel] - [Programs] - [Uninstall a program] in Windows, and remove “Network Camera View 4S”.
- If installation of the plug-in viewer software fails, close Internet Explorer with [X] while the above screen is displayed and then click [Next].

■ User authentication

The unit can be configured to allow **access from the internet**. To prevent infringement of privacy and personality rights, information leaks, and other issues concerning **unauthorized access by third parties**, we recommend enabling the user authentication function upon installation. We also recommend using DIGEST authentication when connecting to a device that supports DIGEST authentication.

- The AW-RP50 supports DIGEST authentication.

Preparation:

1. Startup the web browser and display the “Live” page on a PC.
2. Click “Setup” button and then click “User mng.” button.

The user authentication window will be displayed.

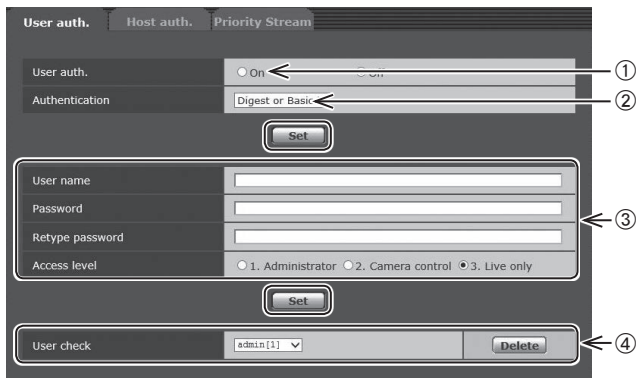

- ① **Select “On” for “User auth.”**
* Set to “Off” by default.
⇒ Then click “Set” button.
- ② (When using a device that supports DIGEST authentication)
Select “Digest” for “Authentication”.
⇒ Then click “Set” button.
- ③ **Register a new user name and password**
* Select “1. Administrator” for the access level.
⇒ Then click “Set” button.
- ④ **Delete the default user name.**
⇒ Click the “Delete” button after selecting the user name to be deleted (“admin[1]”).

* Depending on the model used, the screens shown in the explanations may differ to the actual camera screens.

User name and password management

- **Use a combination of characters and numbers that is difficult to guess.**
Avoid using a string of the same characters, such as “11111”, birth dates, or telephone numbers.
For details on valid characters and lengths, refer to “User authentication settings tab [User auth.]” (page 101).
- **Change user names and passwords periodically.**
- **Make sure to manage the configured user names and passwords.**
- **Delete all user names that do not have an assigned user.**

After changing the user name/password

Also change the user names and passwords registered to the following.

Refer to the operating instructions provided with your camera for further information about the settings used for your camera.

- Remote camera controller (AW-RP50)
- Browsers and applications on computers, tablets, and smartphones.

Basic shooting operations

1 Set the subject brightness to the appropriate level.

With the basic operations, it is assumed that the focus, iris and white balance will be adjusted automatically (as per the factory settings).

2 Turn on the power of all the units and devices in the system.

If the settings have already been changed and the original settings are to be restored, refer to the “What to do when encountering problems in the basic shooting operations” (page 34) and “Camera screen” (page 46) in “Camera menu items”.

3 Select the unit to be operated.

Even when using only one unit, it must still be selected from the wireless remote control or controller.

4 Select the shooting mode.

Select one of the four (Full Auto, Manual1, Manual2 and Manual3) preset shooting modes (scene files), each of which corresponds to a set of circumstances in which the subject will be shot.

Select the mode that satisfies the shooting conditions and suits your preferences.

When continuing to shoot in the same circumstances, there is no need to select another mode.

5 Start shooting. (After shooting, turn off the power of all the units and devices in the system.)

Note

- If “Full Auto” has been selected as the setting for Scene on the camera menu, for example, all the auto settings will be turned on, and manual operations will no longer be possible for some of the items.

How to turn the power on and off

■ Turning the power on

When performing the operations using the wireless remote control

- 1 Set all the power switches of the units and devices connected in the system to ON.**
 - The unit does not have a power switch. When power is supplied to it, the status display lamp will light up orange.
- 2 Press one of the [CAM1] to [CAM4] buttons on the wireless remote control to select the unit.**
- 3 Press the [ON/STANDBY] button on the wireless remote control for 2 seconds.**

The POWER ON mode is established, images are output, and control can be exercised.

 - The unit's status display lamp now lights up green.

Note

- When the camera is turned on for the first time after purchase, it enters the STANDBY mode.

Notes

- It takes about 30 seconds per unit for the initial settings operation to be completed. During this period, the unit cannot be operated.
- The unit stores its STANDBY / POWER ON mode status in the memory.
- If the power supply is cut off while the operation is in POWER ON mode, the operation will transferred to the POWER ON mode the next time power is supplied.
- When transferring to the STANDBY mode**
(Status display lamp: Orange)
The pan/tilt position is stored in the memory, and the pan/tilt unit is moved so that it points backwards.
- When transferring to the POWER ON mode**
(Status display lamp: Green (after the initial setting operation is completed))
The pan/tilt unit is moved to the position which was stored in the memory when the transition to the STANDBY mode was made.
- POWER ON preset**
The pan/tilt unit is moved to the setting, which was established immediately prior to the transition to the STANDBY mode, when the power has been turned on.
- If the power is turned off without transferring to the STANDBY mode, the pan/tilt unit position will not be stored in the memory or reflected in the POWER ON preset. The previous POWER ON preset will be applied.

- 4 If a multiple number of units are going to be used, repeat steps 2 and 3 as required.**

The unit's status display lamp blinks green when a signal matched by the remote control ID has been received, and it blinks orange when a signal that is not matched by the remote control ID has been received.

■ Turning the power off

When performing the operations using the wireless remote control

- 1 Press one of the [CAM1] to [CAM4] buttons on the wireless remote control to select the unit.**
- 2 Press the [ON/STANDBY] button on the wireless remote control for 2 seconds.**

The unit enters STANDBY mode.

 - The unit's status display lamp now lights up orange.
- 3 If a multiple number of units are used, repeat steps 1 and 2 as required.**
- 4 Set all the power switches of the units and devices connected in the system to OFF.**

When performing the operations using the controller

When using an AW-RP50:

Refer to the Operating Instructions of the controller.

Priority mode (Priority Mode)

Changing the priority mode enables the unit to perform operation for various applications. (page 56, page 77)

IP:

Enables IP image transmission over multiple channels. The IP transmission of H.264 images is also supported.

SD card:

Inserting an SD card (optional accessory) into the unit enables recording H.264 images to the SD card. The data recorded to the SD card can be played back on the Web screen, downloaded to a personal computer, and transferred to an FTP server.

USB:

Enables the unit to be used as a Web camera. The camera can also be controlled from a personal computer.

NDI|HX:

Transmits video to NewTek NDI compatible software applications and hardware devices over a network. The function supports H.264/IP transmission using NDI|HX.

Functions that can be and functions that cannot be controlled simultaneously

Priority Mode	MJPEG IP streaming	H.264 IP streaming	Recording MP4 to SD card	USB Video Class
IP	1920×1080 1280×720 640×360 320×180	1920×1080 1280×720 640×360 320×180	—	—
SD card	640×360 320×180	—	1920×1080 1280×720	—
USB	640×360 320×180	—	—	1920×1080 1280×720 640×360

- For the restrictions on IP streaming, refer to page 86.
- The OSD menu cannot be displayed for the IP image when the Priority Mode is set to [NDI|HX]. However, it can be displayed over video output to an external monitor.

Selecting the units

When performing the operations using the wireless remote control

1 Press the [CAM1], [CAM2], [CAM3] or [CAM4] button.

The unit's status display lamp blinks green when a signal matched by the remote control ID has been received, and it blinks orange when a signal that is not matched by the remote control ID has been received.

When performing the operations using the controller

When using an AW-RP50:

Refer to the Operating Instructions of the controller.

Selecting the shooting modes (scene files)

■ Types of shooting modes

The unit has four preset shooting modes, each of which corresponds to a set of circumstances in which the subject will be shot.

Select the mode that satisfies the shooting conditions and suits your preferences.

The settings can be changed by menu operations.

- The results of the white balance and other adjustments are stored in the memory separately by shooting mode. Be absolutely sure to select the shooting mode before making any adjustments.

Note

- If "Full Auto" has been selected as the setting for Scene on the camera menu, for example, all the auto settings will be turned on, and manual operations will no longer be possible for some of the items.

Full Auto

Adjust the shutter speed, aperture, and white balance automatically.

Manual1

The settings of your preferences can be established in line with the shooting scene, lighting and other conditions.

Manual2

The settings of your preferences can be established in line with the shooting scene, lighting and other conditions.

Manual3

The settings of your preferences can be established in line with the shooting scene, lighting and other conditions.

Selecting the shooting modes (scene files) (continued)

How to select the shooting mode

When performing the operations using the wireless remote control

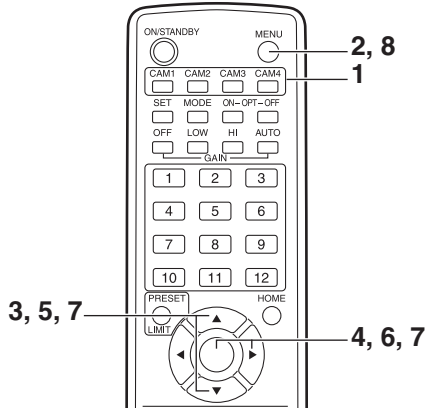

1 Press the [CAM1], [CAM2], [CAM3] or [CAM4] button to select the unit.

2 Press the [MENU] button for 2 seconds.
The Top Menu is displayed.

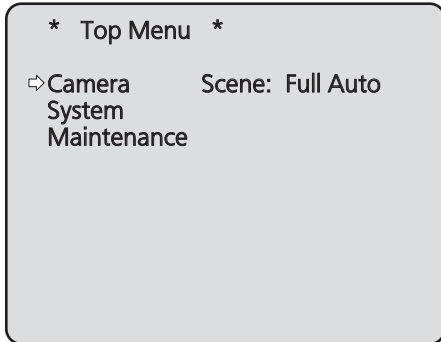

3 Press the [▲] or [▼] button to bring the cursor to "Camera".

4 Press the [○] button.
The "Camera" sub-menu is displayed on the monitor.

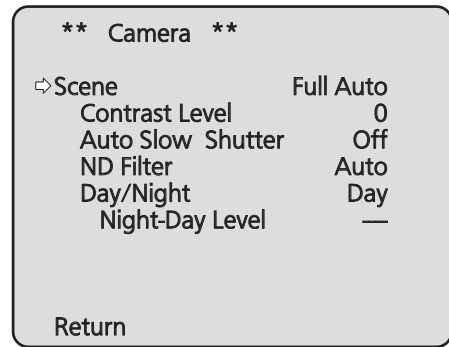

5 Press the [▲] or [▼] button to bring the cursor to "Scene".

6 Press the [○] button.
The shooting mode blinks.

7 Press the [▲] or [▼] button to select the shooting mode (Full Auto, Manual1, Manual2 or Manual3) to be used, and press the [○] button to enter the selection.

8 Press the [MENU] button for 2 seconds.
The camera menu display is exited.

When performing the operations using the controller

When using an AW-RP50:

Refer to the Operating Instructions of the controller.

Shooting

When performing the operations using the wireless remote control

● Changing the camera's direction

Moving the camera toward the left or right (panning):
Press the [◀] or [▶] button.

Moving the camera up or down (tilting):
Press the [▲] or [▼] button.

Moving the camera diagonally:
Press the [▲] or [▼] button and [◀] or [▶] button at the same time.

Returning the camera to the reference position:
Press the [HOME] button for 2 seconds.

● Using the zoom function

Zooming in (the subject becomes magnified in size):
Press the [T] button of [ZOOM].

Zooming out (the subject becomes reduced in size):
Press the [W] button of [ZOOM].

● Switching the direction or zoom speed

Changing the direction or zoom at high speed:
Press the [FAST] button.
When this button is held down, the speed can be set to an even higher speed.
When it is tapped, the normal speed (high speed) is restored.

Changing the direction or zoom at low speed:
Press the [SLOW] button.
When this button is held down, the speed can be set to an even lower speed.
When it is tapped, the normal speed (low speed) is restored.

The lens focus control speed is also changed at the same time.

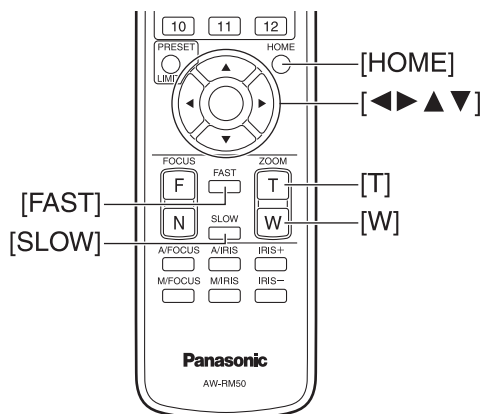

When performing the operations using the controller

● Changing the camera's direction

Moving the camera toward the left or right (panning):
Tilt the [PAN/TILT] lever toward L or R.

Moving the camera up or down (tilting):
Tilt the [PAN/TILT] lever toward UP or DOWN.

Moving the camera diagonally:
Tilt the [PAN/TILT] lever diagonally.

Returning the camera to the reference position:
If the controller has a [HOME] button, press the [HOME] button.

● Using the zoom function

Zooming in (the subject becomes magnified in size):
Tilt the [ZOOM] lever toward the TELE direction.

Zooming out (the subject becomes reduced in size):
Tilt the [ZOOM] lever toward the WIDE direction.

● Changing the pan/tilt direction and zoom speed

When using an AW-RP50:

Refer to the Operating Instructions of the controller.

What to do when encountering problems in the basic shooting operations

If the trouble is not resolved by taking the action suggested below, refer to “Troubleshooting” (page 139).

When performing the operations using the wireless remote control

The unit does not move.

- Press the [CAM1], [CAM2], [CAM3] or [CAM4] button to select the unit which is to be operated.
If only one unit is being used, it is normally selected using the [CAM1] button.
- Check that the IR ID has been set correctly. (page 60, page 99)
- If the unit’s status display lamp is off or lights up orange, it means that the unit’s power is not on.
Refer to “Turning the power on” (page 29), and turn on the power.
- If the unit’s status display lamp does not blink even when the wireless remote control is operated near the unit’s wireless remote control signal light-sensing area, it means that the wireless remote control’s batteries have run down. Replace the batteries.

Multiple color bands (color bars) are displayed.

Press the [MODE] button to switch to the camera picture.

The menu screen is displayed.

Press the [MENU] button for 2 seconds to exit the camera menu.

The lens focus is not adjusted automatically.

Press the [A/FOCUS] button to switch to auto focusing.

The camera picture is too light or too dark.

1. Press the [A/IRIS] button to switch the lens iris adjustment to auto.
2. Press the [AUTO] button of [GAIN] to switch the gain adjustment to auto.

Something is wrong with the coloring of the camera pictures.

Refer to “Auto tracking white adjustment (ATW)” (page 41), and switch to “ATW”.

When performing the operations using the controller

The unit does not move.

- Select the unit to be operated by following the procedure below.

When using an AW-RP50:

Refer to the Operating Instructions of the controller.

- If the unit’s status display lamp is off or lights up orange, it means that the unit’s power is not on.
Refer to “Turning the power on” (page 29), and turn on the power.

Multiple color bands (color bars) are displayed.

Press the [BARS] button to switch to the camera picture.

The menu screen is displayed.

Press the [CAMERA OSD] button to exit the camera menu.

The lens focus is not adjusted automatically.

Press the [AUTO] button for focus control to switch to auto focusing.

The camera picture is too light or too dark.

- Press the [AUTO] button for IRIS to switch to auto lens iris adjustment.
- Press the [AUTO] button for GAIN to switch to auto gain adjustment.

Something is wrong with the coloring of the camera pictures.

Refer to “Auto tracking white adjustment (ATW)” (page 41), and switch to “ATW”.

More advanced operations

Manual shooting (pages 36 to 37)

- Manual adjustment of focus
- Manual adjustment of iris
- Manual adjustment of shutter speed
- Manual adjustment of gain

Preset memories (page 38)

- Up to 100 settings for the camera direction (panning and tilting), zoom, focus, iris, gain up and white balance can be registered in the preset memories, and called.
- The number of settings that can be registered and called depends on the type of wireless remote control (12 settings) or controller that is used for operation.

White balance adjustment (pages 39 to 42)

- This adjustment is performed to express the white accurately. Its setting also has an effect on the color tones of the entire screen.
- It must be performed when using the unit for the first time or when the unit has not been used for a prolonged period.
- It must be performed when the lighting conditions or brightness has changed.
- Once the white balance has been attained, no further adjustment is required provided that the unit is going to be used under the same conditions.

Black level (master pedestal) adjustment (page 43)

- This adjustment is performed to align the black level (pedestal level) of a multiple number of cameras.

Genlock adjustment (page 54)

- This adjustment is performed to achieve phase alignment by applying external synchronization (genlock) when a multiple number of cameras will be used or when the unit will be used in combination with other devices.

Manual shooting

■ Manually adjusting the focus

The lens focus can be adjusted manually.

When performing the operations using the wireless remote control

- 1 Press the [M/FOCUS] button to switch the focus to manual adjustment.
- 2 Press the [F] or [N] button of [FOCUS] to adjust the focus.
When the [F] button is pressed, the focus moves further away (far); conversely, when the [N] button is pressed, it moves nearer (near).
The speed of focusing and other adjustments can be switched to fast or slow by pressing the [FAST] or [SLOW] button, respectively.
- 3 If necessary, press the [A/FOCUS] button to return the focus to the automatic adjustment.

When performing the operations using the controller

When using an AW-RP50:

Refer to the Operating Instructions of the controller.

Note

- When the focus is set to manual, the subject may go out of focus during panning, tilting and zooming. Therefore, the unit comes with a function which compensates for this. (Focus compensation during zooming function: Focus ADJ With PTZ.) (page 58, page 95, page 98)

■ Manually adjusting the iris

The lens iris can be adjusted manually.

When performing the operations using the wireless remote control

- 1 Press the [M/IRIS] button to switch the iris to manual adjustment.
- 2 Adjust the iris using the [IRIS +] or [IRIS -] button.
Press the [IRIS +] button to adjust the lens iris in the opening direction; conversely, press the [IRIS -] button to adjust the lens iris in the closing direction.
- 3 If necessary, press the [A/IRIS] button to return the iris to the automatic adjustment.

When performing the operations using the controller

When using an AW-RP50:

Refer to the Operating Instructions of the controller.

Memo

- In Night mode, the iris is set to open as a measure to prevent video spying.
Adjust the brightness at the light source.
-

Manual shooting (continued)

Manually adjusting the shutter speed

The shutter speed can be set using two methods. One is a method that specifies the time (where a time such as 1/250 sec. is designated), and the other is a method that specifies the frequency (where synchro scan, 60.15 Hz, etc. is designated).

When shooting a TV screen or PC monitor screen, the horizontal noise generated when the screen is shot can be minimized by adjusting the frequency to the screen frequency using synchro scan.

Note

- The shutter speed cannot be adjusted manually when HDR is set to "Low" or "High". (page 51)

When performing the operations using the wireless remote control

Perform the adjustments on the Camera menu. For further details, refer to the [Shutter Mode] and [Step/Synchro] items on page 47 and page 48.

When performing the operations using the controller

Note

- When the following settings are made on the AW-HE42, the shutter speed cannot be manually adjusted (as the camera is locked in auto mode).
 - Shooting mode (Scene) is in "Full Auto" (pages 31 to 32)
 - Contrast Mode is in "Auto" (page 47)

When using an AW-RP50:

For details, refer to the operating instructions supplied with the controller.

Manually adjusting the gain

There are two ways to adjust the gain. One way involves using the buttons on the wireless remote control or controller; the other way involves using the Camera menu or Web setting.

The gain can be adjusted more precisely using the Camera menu or Web setting.

For further details, refer to the [Gain] item on page 48 and page 89.

Notes

- When Shooting mode (Scene) on the AW-HE42 is set to "Full Auto", the gain cannot be manually adjusted (as the camera is locked in auto mode). For details, refer to "Selecting the shooting modes (scene files)" (pages 31 to 32).
- The gain cannot be adjusted manually when HDR is set to "Low" or "High". (page 51)
- When adjusting the gain, the light quantity may change suddenly (causing the image output to be subjected to a shock).

When performing the operations using the wireless remote control

1 Press the [OFF], [LOW] or [HI] button.

These buttons enable the gain increase to be selected in three steps.

[OFF] is set to 0 dB, [LOW] is set to 9 dB, and [HI] is set to 18 dB.

2 If necessary, press the [AUTO] button in order to return the gain to the automatic adjustment (AGC).

When performing the operations using the controller

When using an AW-RP50:

Refer to the Operating Instructions of the controller.

In any case, the maximum gain of the automatic adjustment (AGC) can be set by the camera menu or Web setting. For further details, refer to the [AGC Max Gain] item on page 48 and page 90.

Preset memories

The unit enables up to 100 settings for the camera direction (panning and tilting), zoom, focus, iris, gain and white balance to be registered in its preset memories, and called. However, the number of settings that can be registered and called depends on the type of wireless remote control or controller that is used for operation.

- The focus and iris operating modes (manual and auto settings) are not registered.
The current focus and iris values are registered.
- The focus and iris values can be recalled only when the manual settings are applicable.
- ATW, AWB A, AWB B, 3200K, 5600K or VAR is registered as the white balance setting. The values selected when AWB was established are recalled as the adjustment values of AWB A or AWB B.

Notes

- When there is a large difference in the environmental temperature between the time of registration and the time the setting is called, displacement of the preset position may occur.
- When recalling a preset with a different image stabilization setting from when the preset was registered, displacement in the zoom position may occur.
- If displacement occurs, perform registration again.
- Manual operations, such as pan, tilt, zoom, and iris control, can be performed while the recalling of a preset is in progress. However, the preset actions will be canceled.
- If a preset is recalled while the recalling of another preset is in progress, the current preset actions are canceled, and the newly selected preset is recalled.
- Nothing will occur if a preset memory number to which a preset has not been registered is recalled.

When performing the operations using the wireless remote control

Twelve settings (preset No.1 to No.12) can be registered and called using the wireless remote control. The [1] to [12] buttons correspond to the unit's preset memories No.1 to No.12.

● Registering the settings in the preset memories

1 Display the picture to be shot on the monitor.

Operate the pan, tilt or zoom buttons to determine the camera angle.

Adjust the focus, iris, gain and white balance if they need to be adjusted.

2 While holding down the [PRESET] button, press the button corresponding to the preset memory number.

- If a preset memory number with an already registered setting has been selected, the existing setting will be erased and replaced with the new one.

● Calling the settings of the preset memories

1 Press the button in which the preset memory setting has been registered.

When performing the operations using the controller

When using an AW-RP50:

Up to 100 entries can be registered/recalled. For details, refer to the operating instructions for the controller.

White balance adjustment

■ White balance adjustment

In order for the white to be reproduced accurately, the ratio between the three primary colors (RGB) is adjusted. If the white balance has shifted out of adjustment, not only will the white be reproduced poorly but the color tones of the entire screen will also be degraded.

- **This adjustment must be performed when using the unit for the first time or when the unit has not been used for a prolonged period.**
- **It must be performed when the lighting conditions or brightness has changed.**

As the type of adjustment used, AWB (automatic white balance adjustment) which is used to adjust the white balance when the [AWB] button on the controller is pressed, ATW (automatic tracking white balance adjustment) which is used to keep adjusting the white balance at all times, or manual adjustment can be selected.

The results of the AWB adjustment can be stored in two memories, A and B, when “AWB A” or “AWB B” has been selected for the white balance.

- Once the white balance values have been adjusted, their setup procedure will be completed simply by selecting them using the camera menus or web settings, or by pressing the buttons on the controller, provided that they are going to be used under the same conditions as the ones established when the values were set.
There is no need to set it again.
- Once a new setting is entered, the previous setting will be erased.

Use the two memories to store settings corresponding to different shooting conditions.

Note

- When Shooting mode (Scene) on the AW-HE42 is set to “Full Auto”, the white balance cannot be manually adjusted (ATW mode is activated).
For details, refer to “Selecting the shooting modes (scene files)” (pages 31 to 32).

● Automatic adjustment (AWB: AWB A or AWB B)

When performing the operations using the wireless remote control

- 1 Shoot a white subject (such as a white wall or handkerchief) so that it fills the screen.**
 - Do not shoot shiny or very bright objects.
- Steps **2** through **8** represent the procedure for selecting the “AWB A” or “AWB B” memory. They need not be taken if a selection has already been made.

- 2 Select Manual1, Manual2 or Manual3 as the shooting mode by following the procedure in “Selecting the shooting modes (scene files)” (page 32).**

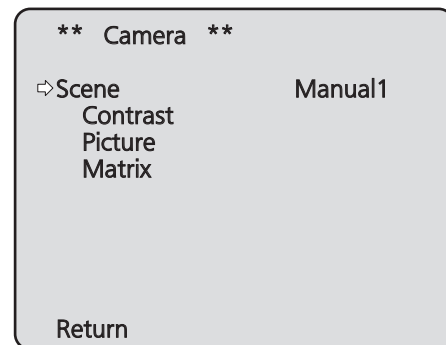

- 3 Press the [▲] or [▼] button to bring the cursor to “Picture”.**

- 4 Press the [○] button.**

The “Picture 1/3” sub-menu is displayed.

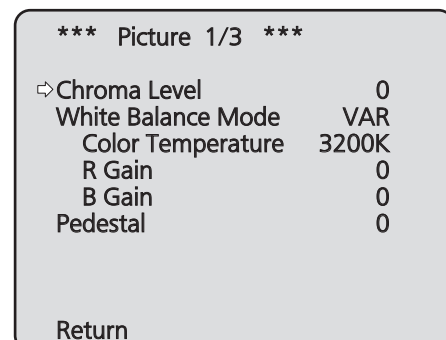

White balance adjustment (continued)

5 Press the [▲] or [▼] button to bring the cursor to “White Balance Mode”.

6 Press the [○] button.

“White Balance Mode” starts blinking.

7 Press the [▲] or [▼] button to change the “White Balance Mode” to be used to “AWB A” or “AWB B”, and press the [○] button to enter the selection.

8 Press the [MENU] button for 2 seconds.

The camera menu display is exited.

9 Press the [SET] button for 2 seconds.

The auto white balance adjustment (AWB) is performed, and the white balance setting is entered.

- When the white balance adjustment is completed successfully, “AWB OK” appears in the center of the screen.

However, this does not appear when “OSD Status” is set to “Off” in the camera menu.

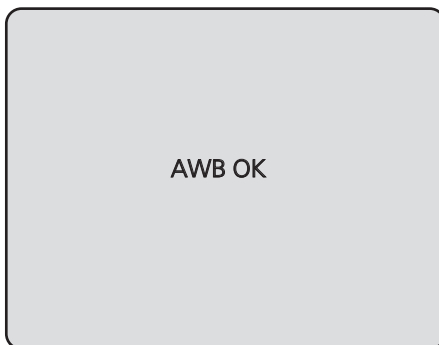

Notes

- The white balance cannot be adjusted when color bars are displayed. Press the [MODE] button to switch to the camera picture.
- When the adjustment has failed, an error message such as “OUT RANGE NG”, “HIGH LIGHT NG”, “LOW LIGHT NG”, “ATW NG”, “3200K NG”, “5600K NG” or “VAR NG” is displayed.
However, this does not appear when “OSD Status” is set to “Off” in the camera menu.
- In Night mode (page 46, page 49), the white balance adjustment cannot be used.

When performing the operations using the controller

When using an AW-RP50:

Refer to the Operating Instructions of the controller.

Notes

- White balance may not be correctly set if the lighting of the object is too weak.
- Since the unit has a built-in memory, the set white balance will remain in the memory even if power is turned off. Therefore, it is not necessary to reset the white balance if the color temperature of those objects remains unchanged. However, it must be reset if the color temperature changes, such as when you move from indoors to outside, or vice versa.

White balance adjustment (continued)

● Auto tracking white adjustment (ATW)

When white balance adjustment is set to “ATW”, the white balance will be corrected automatically, even if the light source or color temperature changes.

This function works when “ATW” is selected instead of “AWB A” or “AWB B” by following the steps for “Automatic adjustment” in “White balance adjustment” (page 39).

Notes

- ATW might not function properly when high brightness light (ex. fluorescent lamp) beams into a screen.
- White balance may not be accurately set if there is no white object in the scene being shot.
- The white balance may shift out of adjustment when a different kind of light source such as sunlight or fluorescent lighting applies.
- When switching from Night mode to Day mode, the white balance may shift out of adjustment.

● 3200K and 5600K presets

When “3200K” or “5600K” is selected for the white balance, the white balance is set using a color temperature of 3200K (equivalent to halogen light) or 5600K (equivalent to daylight), respectively.

This function works when “3200K” or “5600K” is selected instead of “AWB A” or “AWB B” in the “Automatic adjustment” procedure in “White balance adjustment” (page 39).

● Color temperature adjustment (VAR)

When “VAR” is selected for the white balance, you can select a color temperature between 2400K to 9900K.

Note

- The displayed “VAR” value does not guarantee an absolute value.
Use the value as a reference.

White balance adjustment (continued)

● Manual adjustment (R gain and B gain adjustment)

White balance can be adjusted manually.

Note

- R/B gain adjustments can only be performed when “White Balance Mode” is set to “AWB A”, “AWB B” or “VAR”.

When performing the operations using the wireless remote control

- Steps 1 through 6 represent the procedure for selecting the “AWB A”, “AWB B” or “VAR” memory. They need not be taken if a selection has already been made.

- 1 Select Manual1, Manual2 or Manual3 as the shooting mode by following the procedure in “Selecting the shooting modes (scene files)” (page 32).

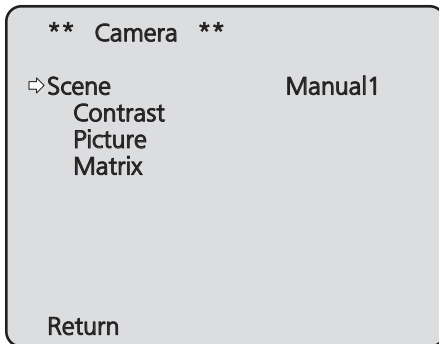

- 2 Press the [▲] or [▼] button to bring the cursor to “Picture”.

- 3 Press the [○] button.

The “Picture 1/3” sub-menu is displayed.

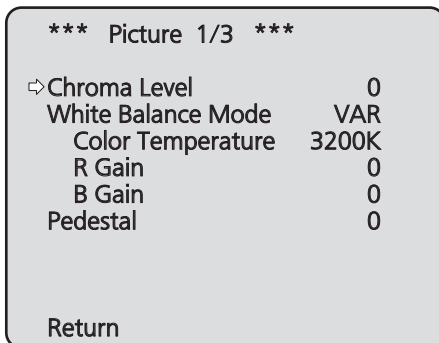

- 4 Press the [▲] or [▼] button to bring the cursor to “White Balance Mode”.

- 5 Press the [○] button.

“White Balance Mode” starts blinking.

- 6 Press the [▲] or [▼] button to change the “White Balance Mode” to “AWB A”, “AWB B” or “VAR”, and press the [○] button to confirm the selection.

- 7 Press the [▲] or [▼] button to bring the cursor to “R Gain” or “B Gain.”

- 8 Press the [○] button to make the “R Gain” or “B Gain” value blink.

- 9 Press the [▲] or [▼] button to change the “R Gain” or “B Gain” numerical value, and press the [○] button to enter the setting.

When performing the operations using the controller

When using an AW-RP50:

Refer to the Operating Instructions of the controller.

Black level (master pedestal) adjustment

■ Black level (master pedestal) adjustment

The black level can be adjusted when using a multiple number of cameras including the unit. Ask your dealer to perform this adjustment.

(Use an oscilloscope or waveform monitor for the adjustment.)

Adjust the black level in accordance with the units and devices used.

The black level can be adjusted only when Manual1, Manual2 or Manual3 is selected as the shooting mode (scene file).

When performing the operations using the wireless remote control

- 1 Press the [M/IRIS] button.**
Set the iris to the manual mode.
- 2 Press the [IRIS -] button.**
The lens iris closes until the image is completely black.
- 3 Select Manual1, Manual2 or Manual3 by following the procedure in “How to select the shooting mode” (page 32) under “Selecting the shooting modes (scene files)”.**
- 4 Press the [▲] or [▼] button to bring the cursor to “Picture”.**
- 5 Press the [○] button.**
The “Picture 1/3” sub-menu is displayed.

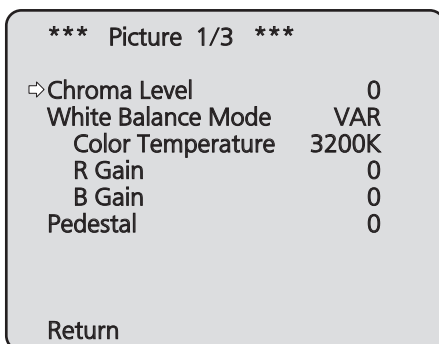

- 6 Press the [▲] or [▼] button, and bring the cursor to “Pedestal”.**

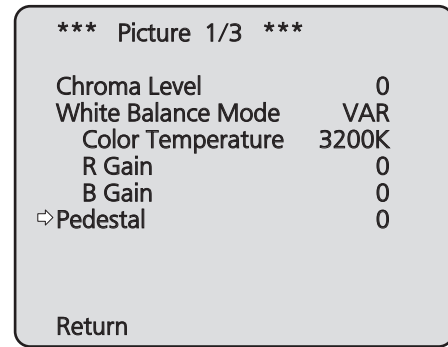

- 7 Press the [○] button to start the “Pedestal” value blinking.**
- 8 Press the [▲] or [▼] button, change the “Pedestal” value, and press the [○] button to enter the selection.**
- 9 Press the [MENU] button for 2 seconds.**
The camera menu display is exited.
- 10 If necessary, press the [A/IRIS] button to adjust the iris automatically.**

When performing the operations using the controller

When using an AW-RP50:

Refer to the Operating Instructions of the controller.

Basic setup operations

Camera menus are displayed on the monitor when the unit's settings are to be selected.

The monitor is connected to the video signal output connector.

The basic camera menu operations involve displaying sub-menus from the Top Menu items, and selecting settings on the sub-menus.

Some sub-menus have menu items for performing more detailed settings.

The camera menu operations are conducted using the wireless remote control.

Described below are the Basic setup operations for changing the camera menu item settings using the wireless remote control.

■ Wireless remote control operations

Camera menu operation	Wireless remote control
Selecting a camera to operate	Press the <CAM1>, <CAM2>, <CAM3>, or <CAM4> button.
Displaying the Top Menu	Press and hold the <MENU> button for about 2 seconds.
Selecting items	Press the <▲>, <▼>, <◀>, or <▶> button.
Displaying sub-menus	Press the <○> button.
Returning to the previous menu	Place the cursor on [Return], and press the <○> button.
Changing settings	Place the cursor on the item you want to change, and press the <○> button to make the setting value blink. Change the value using the <▲>, <▼>, <◀>, or <▶> button, and press the <○> button to confirm.
Canceling setting changes	Press the <MENU> button (hold for less than 2 seconds) while the setting value is blinking.
Exiting camera menu operations	Press and hold the <MENU> button for about 2 seconds.

■ When performing the operations using the wireless remote control

- 1 Press the [CAM1], [CAM2], [CAM3] or [CAM4] button to select the unit which is to be operated.**
- 2 Press the [MENU] button for 2 seconds.**
The Top Menu is displayed.
- 3 Press the [▲] or [▼] button to bring the cursor to the item to be selected.**
Each time the [▲] or [▼] button is pressed, the cursor moves.
The cursor can be moved in the same way using the [◀] and [▶] buttons.
- 4 Press the [○] button.**
The sub-menu of the selected item is displayed.
(Some sub-menu items have a sub-menu of their own.)
- 5 Press the [▲] or [▼] button to bring the cursor to the item to be set.**
Each time the [▲] or [▼] button is pressed, the cursor moves.
The cursor can be moved in the same way using the [◀] and [▶] buttons.
With the cursor at the "Return" position, press the [○] button to return to the previous menu.
- 6 Press the [○] button.**
The value of the item to be set starts blinking.
- 7 Press the [▲] or [▼] button to change the setting.**
The setting can be changed in the same way using the [◀] and [▶] buttons.
- 8 Press the [○] button.**
The value of the item to be set is entered, and it stops blinking.
- 9 After the setting has been completed, press the [MENU] button for 2 seconds.**
The camera menu display is exited.

Camera menu items

■ Setting the camera menu items

When the unit's settings are to be selected, the camera menus are displayed on the monitor.

The monitor is connected to the video signal output connector.

The basic camera menu operations involve displaying sub-menus from the Top Menu items, and selecting settings on the sub-menus.

Some sub-menus have menu items for performing more detailed settings.

The "*" and "#" marks in the menu titles indicate the hierarchical level of the menu currently displayed. For instance, "* Top Menu *" indicates the first hierarchical level whereas "** Camera *" and "## Maintenance ##" indicate that the second hierarchical level is now displayed.

Menu items accompanied by a "*" mark indicate data which is stored on a scene by scene basis; menu items accompanied by a "#" mark indicate data which is stored together for one camera regardless of the scenes.

■ Top Menu screen

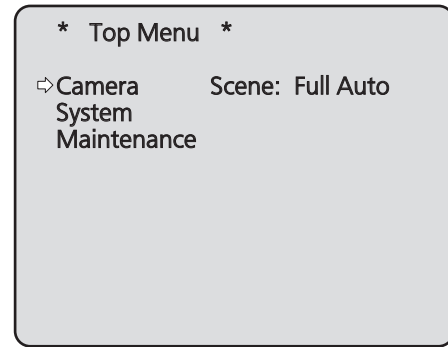

Camera

Select this to open the camera menu relating to the camera images.

System

Display the System menu in which the camera's output image settings are configured.

Maintenance

Display the Maintenance menu which concerns checking the unit's firmware versions, checking the IP address and initialize the settings.

Note

- The Top Menu does not have a "Return" setting.

Camera menu items (continued)

■ Camera screen (when Full Auto is selected)

This menu is used for the camera image settings.

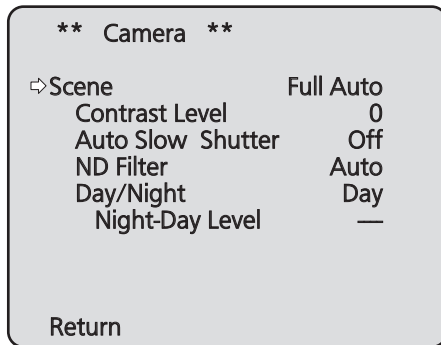

Scene

[Full Auto, Manual1, Manual2, Manual3]

Selected here is the shooting mode that matches the shooting situation.

Select the mode which best suits the prevailing shooting conditions and the user's preferences.

Full Auto: In this mode, the optimum settings and adjustments for the shooting conditions at hand are automatically established. When "Full Auto" has been selected, the detailed setting and adjustment menus are not displayed.

Manual1 to 3: In these modes, the detailed settings and adjustments are established manually to match the prevailing shooting conditions and the user's preferences. When the Manual1, Manual2 or Manual3 mode has been selected, the detailed setting and adjustment menu for the mode concerned is displayed.

Contrast Level [-10 to +10]

Set here is the contrast level when the image brightness is adjusted.

Auto Slow Shutter [Off, On]

Determines whether or not Auto Slow Shutter is used.

- This can only be configured when "Scene" is set to "Full Auto".

ND Filter

[Auto, Through, 1/4, 1/16, 1/64]

Adjust light intensity by switching between optical ND filters that are built into the unit.

Auto: Automatically switches ND filters depending on the lighting conditions of the subject and shooting location.

- This can only be configured when "Scene" is set to "Full Auto".

Through: ND filter is not used.

1/4: Reduces light intensity to 1/4.

1/16: Reduces light intensity to 1/16.

1/64: Reduces light intensity to 1/64.

Notes

- When "Night" is selected for Day/Night, the setting is fixed to "Through".
- When "Auto" is selected for Day/Night, you can select either "Auto" or "Through".
- When "Auto" is selected, ND filters are switched automatically. When filters are switched, there will be a momentary marked change in image brightness.
- Depending on the surrounding environment and conditions of use, filter switching may not occur as expected even when "Auto" is selected.

Day/Night [Day, Night, Auto]

This is used to select normal shooting or low light shooting (by exposing the subjects to infrared rays).

For details, refer to "Contrast 2/2 screen" (page 48).

Night-Day Level [Low, Mid, High]

Adjust the level used while switching from Night mode to Day mode when Day/Night is set to "Auto".

- This can only be configured when Day/Night is set to "Auto".

Return

Use this to return to the previous menu.

Camera menu items (continued)

■ Camera screen (when Manual1 to 3 is selected)

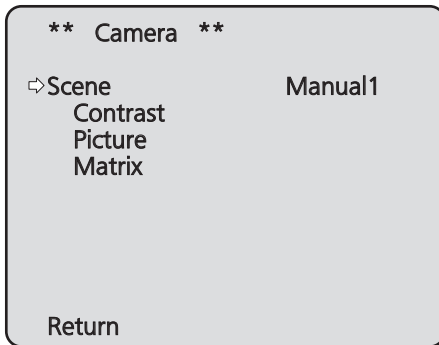

Scene

[Full Auto, Manual1, Manual2, Manual3]

Refer to section on Scene in the column on page 46.

Contrast

Select this to display the Contrast screen to adjust the brightness.

Picture

This menu item displays the Picture screen on which to adjust the picture quality.

Three screens (Picture 1/3, Picture 2/3 and Picture 3/3) are provided for the picture quality adjustment menu.

Matrix

This menu item is used to adjust the 16-axis color matrix.

Return

Use this to return to the previous menu.

■ Contrast 1/2 screen

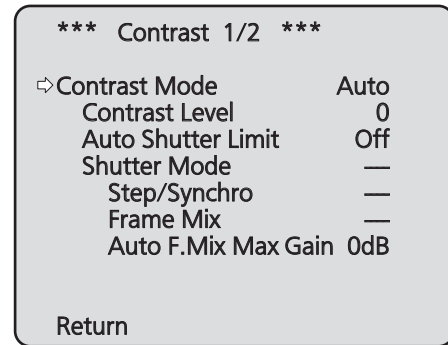

Contrast Mode [Auto, Manual]

This item is used to select whether the image brightness (contrast) is to be controlled automatically or manually.

Auto: The iris, shutter speed and frame addition are controlled and the camera brightness is adjusted automatically.

Manual: Operations are performed using the manually set values.

Contrast Level [–10 to +10]

Set here is the contrast level when the image brightness is adjusted.

This item can be set when “Auto” has been selected as the “Contrast Mode” setting.

Auto Shutter Limit

For 59.94Hz:

[Off, 1/60, 1/100, 1/120, 1/250]

For 50Hz:

[Off, 1/50, 1/100, 1/125, 1/250]

Sets the shutter speed limit that applies when using Auto Shutter.

- This setting is effective when “Scene” is set to “Manual1” to “Manual3” and “Contrast Mode” is set to “Auto”.

Note

- Setting a shutter speed limit restricts the range of brightness that can be followed, so overexposure may occur with brightly lit subjects. In such cases, change the “ND Filter” setting to adjust light intensity as needed.

Shutter Mode [Off, Step, Synchro]

Select for camera shutter mode.

This item can be set when “Manual” has been selected as the “Contrast Mode” setting.

Off: The shutter is set to OFF (so that it cannot be tripped).

Step: The step shutter is set (the steps can be changed).

Synchro: The synchro shutter is set (the setting can be changed continuously).

Camera menu items (continued)

Step/Synchro

This is used to adjust the shutter speed in the mode which was selected as the "Shutter Mode" setting.

When a higher shutter speed is selected, fast-moving subjects do not become blurred easily but the images will be darker.

The shutter speeds that can be set are listed below.

[When 59.94 Hz has been set as the unit's frequency]

When "Step" is selected as the "Shutter Mode"	When "Synchro" is selected as the "Shutter Mode"
1/100, 1/250, 1/500, 1/1000, 1/2000, 1/4000, 1/10000	59.94 Hz to max. 660.09 Hz (255 steps)

[When 50 Hz has been set as the unit's frequency]

When "Step" is selected as the "Shutter Mode"	When "Synchro" is selected as the "Shutter Mode"
1/120, 1/250, 1/500, 1/1000, 1/2000, 1/4000, 1/10000	50.00 Hz to max. 570.12 Hz (255 steps)

Frame Mix [Auto, Off, 6dB, 12dB, 18dB, 24dB]

Select for frame addition (gain-up using sensor storage) amount.

This item can be set when "Off" is selected as the "Shutter Mode" item setting.

When frame addition is performed, it will appear as if the images are missing some frames.

Auto F.Mix Max Gain [0dB, 6dB, 12dB, 18dB]

When "Auto" for the "Contrast Mode" or "Auto" for the "Frame Mix" is selected, the maximum frame addition amount can be set.

If frame addition is performed at the Auto setting, it will appear as if the images are missing some frames.

Return

Use this to return to the previous menu.

■ Contrast 2/2 screen

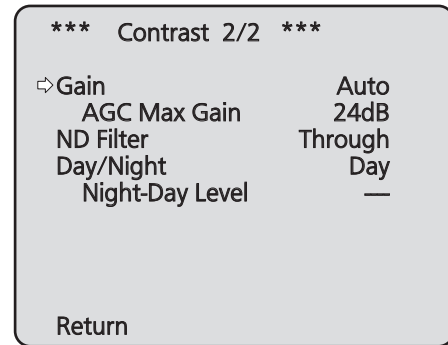

Gain

[Auto, 0dB, 3dB, 6dB, 9dB, 12dB, 15dB, 18dB, 21dB, 24dB, 27dB, 30dB, 33dB, 36dB, 39dB, 42dB, 45dB, 48dB]

The image gain is adjusted here.

In locations which are too dark, adjust the gain upward; conversely, in locations which are too bright, adjust it downward.

When "Auto" is set, the light quantity is adjusted automatically.

The noise increases when the gain is increased.

AGC Max Gain

[6dB, 12dB, 18dB, 24dB, 30dB, 36dB, 42dB, 48dB]

When "Auto" is selected as the "Gain" setting, the maximum gain-up amount can be set.

ND Filter [Through, 1/4, 1/16, 1/64]

For details, refer to "ND Filter" (page 46).

Camera menu items (continued)

Day/Night [Day, Night, Auto]

This is used to select normal shooting or low light shooting (by exposing the subjects to infrared rays).

Day: Normal shooting

Night: Low light shooting

Auto: Automatically switch between standard shooting and night-vision shooting depending on the lighting conditions of the subject and shooting location.

Notes

- In Night mode, Black-and-white images are output. The lens iris is forcibly set to open.
- In Night mode, the white balance adjustment cannot be used.
- When focus is set to manual, the focus may shift when switching between Day and Night mode, depending on the shooting conditions. If necessary, either adjust the focus or set the focus to auto.
- Even when "Auto" is selected, shooting may not switch between Day and Night mode as expected, depending on the subject.

In such cases, perform the following adjustments.

Switching from Day mode to Night mode

Switch when the gain value and frame storage value are at their maximum due to brightness adjustment.

When the shooting mode (Scene) is "Manual1" to "Manual3", you can adjust the AGC Max Gain and Auto F.Mix Max Gain settings.

Switching from Night mode to Day mode

You can adjust with the Night-Day Level setting. If you perform a close-up on a black object, the unit may switch to Night mode, even after performing the above adjustments.

Night-Day Level [Low, Mid, High]

Adjust the level used while switching from Night mode to Day mode when Day/Night is set to "Auto".

This can only be configured when "Day/Night" is set to "Auto".

Return

Use this to return to the previous menu.

Camera menu items (continued)

Picture 1/3 screen

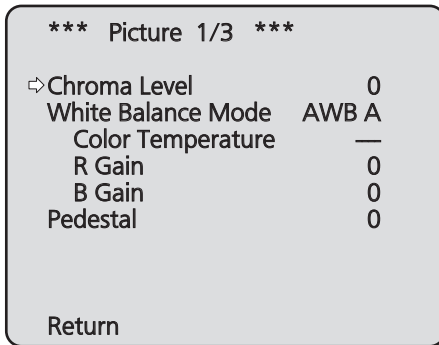

Chroma Level [-3 to +3]

Set here is the color intensity (chroma level) of the images.

White Balance Mode

[ATW, AWB A, AWB B, 3200K, 5600K, VAR]

The white balance mode is selected here.

Select the mode when the coloring is not natural because of the nature of the light source or other factors.

If the white color serving as the reference can be recognized, subjects can be shot with natural coloring.

ATW: This mode automatically corrects the white balance, even if the light source or color temperature changes.

AWB A, AWB B:

When AWB A or AWB B is selected and the white balance is executed, the adjustment results obtained are stored in the memory selected. When AWB A or AWB B is then selected, the white balance stored in the selected memory can be recalled.

3200K:

This white balance mode is ideal when a 3200K halogen light is used as the light source.

5600K:

This white balance mode is ideal when 5600K sunlight or fluorescent lighting is used as the light source.

VAR: Specify a color temperature from 2400K to 9900K.

Color Temperature [2400K to 9900K]

Specify a color temperature from 2400K to 9900K (in increments of about 100K).

This is enabled when White Balance Mode is set to "VAR".

R Gain, B Gain [-30 to +30]

When "AWB A", "AWB B" or "VAR" is selected as the White Balance Mode setting, the white balance can be finely adjusted after automatic white balance (AWB) has been performed.

Notes

- When automatic white balance (AWB) is executed, the R Gain and B Gain values are returned to "0".
- When "AWB A", "AWB B" or "VAR" is selected as the White Balance Mode setting, the R Gain and B Gain adjustment values can be stored in the three memories, A, B and VAR.
- When new values are set, the previous values are erased. Use each of the memories for a different purpose in accordance with the shooting conditions.
- R Gain and B Gain adjustments cannot be performed when White Balance Mode is set to "ATW", "3200K", or "5600K".

Pedestal [-10 to +10]

This item is used to adjust the black level (adjust the pedestal) so that the dark parts of the images are easier to see.

These parts become darker when a negative setting is selected and, conversely, lighter when a positive setting is selected.

Return

Use this to return to the previous menu.

Camera menu items (continued)

Picture 2/3 screen

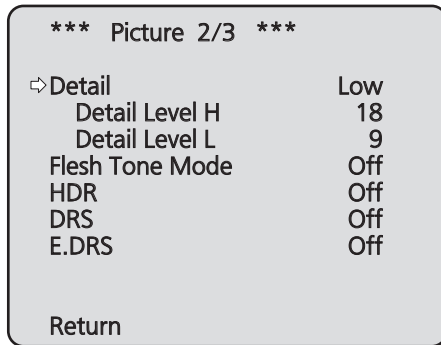

Detail [Off, Low, High]

The image detail (image sharpness) is adjusted here.
When “Low” or “High” is selected, the detail is enhanced.

Detail Level H

[Detail Level L setting +1 to 18]

The image sharpness level is adjusted here when “High” has been selected as the “Detail” setting.

Detail Level L

[1 to Detail Level H setting –1]

The image sharpness level is adjusted here when “Low” has been selected as the “Detail” setting.

Flesh Tone Mode [Off, Low, High]

Set here is the flesh tone mode for displaying the subjects’ skin so that it appears more smoothly and eye-pleasingly.
When “Low” or “High” is selected, the effect is enhanced.

HDR [Off, Low, High]

Adjust the effect of the high dynamic range mode.
When HDR is set to “Low”, correction is performed so that the appropriate exposure is obtained for the light and dark areas on subjects with extremely high contrast. When “High” is selected, dark areas are made brighter.
Depending on the shooting conditions, however, the picture quality may drop with increased noise.
In addition, unit vibration may result in blurry or distorted images.
This effect is not recommended in shooting locations where significant vibration may occur.

Notes

- When the HDR setting is changed, the monitor images will go momentarily black and the audio will be muted. Furthermore, IP video may stop for about 30 seconds.
- When “Low” or “High” is selected, it will take longer for the brightness of the image to converge.
- When “Low” or “High” is selected, brightness cannot be adjusted.

Notes

- When “Low” or “High” is selected, video will be delayed by 4 frames.
- When “Low” or “High” is selected, the following settings cannot be changed.
 - Auto Shutter Limit
 - ND Filter
 - Day/Night
 - Night-Day Level
 - Pedestal
 - DRS
 - Gamma Type
 - Back Light COMP.
 - Freeze During Preset
- When “Low” or “High” is selected, the OSD menu cannot be displayed for the video on the Web screen. However, the OSD menu can be displayed over video output to a monitor.
- When the Priority Mode (page 56, page 77) selection is “NDI|HX”, this item is fixed to “Off”.
- When the OIS (page 59, page 98) selection is “Mode2”, changing the HDR setting to “Low” or “High” automatically switches the OIS setting to “Mode1”.

DRS [Off, Low, High]

Set here is the DRS function which provides just the right amount of compensation when images with significant light/dark differences are displayed.
When “Low” or “High” is selected, the effect is enhanced even more.
Depending on the shooting conditions, however, the picture quality may drop with increased noise.

Camera menu items (continued)

E.DRS [Off, Low, High]

Sets the E.DRS function, which provides a greater amount of compensation than DRS does when images with significant light/dark differences are displayed. Select "Low" or "High" to enhance the compensation effect. Depending on the shooting conditions, however, the picture quality may drop with increased noise.

Notes

- When "Low" or "High" is selected, the brightness is automatically adjusted.
To adjust the brightness convergence level, change the Contrast Level setting.
- When "Low" or "High" is selected, the following settings cannot be changed.
 - Day/Night
 - Night-Day Level
 - DRS
 - HDR
 - Gamma Type
 - Back Light COMP.
- Only one item, HDR, DRS or E.DRS, can be enabled.
To enable E.DRS, set HDR and DRS to "Off".
- When the Priority Mode (page 56, page 77) selection is "NDI|HX", this item is fixed to "Off".

Return

Use this to return to the previous menu.

Picture 3/3 screen

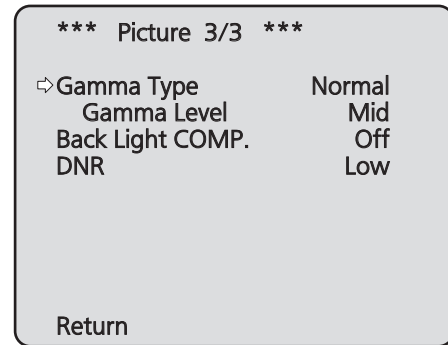

Gamma Type [Off, Normal, Cinema]

Selected here is the type of gamma curve. Normally, the "Normal" setting is used. When "Cinema" is selected, images giving off an atmosphere like movies can be shot.

Gamma Level [Low, Mid, High]

This item is used to adjust the gamma compensation level. This is enabled when Gamma Type is set to "Normal". When "Low" is set, the images appear sedate and composed. The resulting gamma curve has a gentle gradient in the low-brightness areas, and the contrast is sharper. Conversely, when "High" is set, the tonal range in the dark area is expanded so that the images take on a lighter tone. The resulting gamma curve has a sharp gradient in the low-brightness areas, and the contrast is softer.

Back Light COMP. [Off, On]

"On" or "Off" is set here for the backlight compensation function. Under backlight conditions, the function prevents darkening as a result of light striking the backs of subjects, and makes it possible to shoot images in shade or shadow more brightly.

Notes

- The function takes effect when "Auto" has been selected as the Contrast Mode, Gain or Frame Mix item setting.
- When Day/Night is set to "Auto", this is set to "Off".
- When HDR is set to "Low" or "High", this is set to "Off".

DNR [Off, Low, High]

Set here is the level of the digital noise reduction effect so that light, noise-free and clear images will be output even at night and in other low-brightness environments. When "Low" or "High" is selected, noise can be eliminated. However, there is an increased possibility that afterimages may occur.

Return

Use this to return to the previous menu.

Camera menu items (continued)

16-axis color matrix

(These operations can be performed only when Manual1 to 3 has been selected as the Scene setting.)

<Matrix 1/3 screen>

```

*** Matrix 1/3 ***
⇨ Matrix Type          Normal
   [ Saturation ] [ Phase ]
B                —      —
B_B_Mg          —      —
B_Mg_Mg         —      —
Mg              —      —
Mg_R            —      —
R               —      —
Return
    
```

<Matrix 2/3 screen>

```

*** Matrix 2/3 ***
⇨ Matrix Type          Normal
   [ Saturation ] [ Phase ]
R_R_YI          —      —
R_YI_YI         —      —
YI              —      —
YI_YI_G         —      —
YI_G_G          —      —
G               —      —
Return
    
```

<Matrix 3/3 screen>

```

*** Matrix 3/3 ***
⇨ Matrix Type          Normal
   [ Saturation ] [ Phase ]
G_Cy            —      —
Cy              —      —
Cy_Cy_B         —      —
Cy_B_B         —      —
Return
    
```

Matrix Type [Normal, EBU, NTSC, User]

The preset color matrix data is loaded, and the saturation and phase are compensated accordingly.

When "User" is selected, the saturation and phase can be finely adjusted using the 16-axis color matrix (B to Cy_B_B).

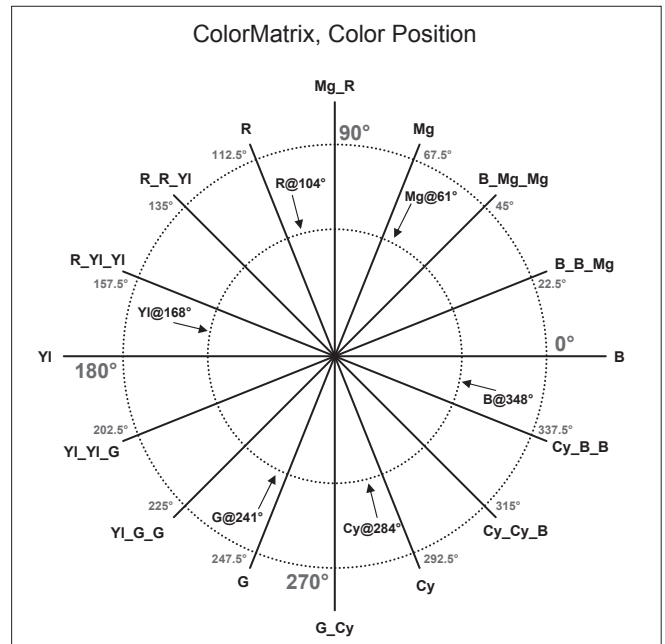

B to Cy_B_B: Saturation [-31 to +31]

The saturation of B to Cy_B_B can be finely adjusted.

B to Cy_B_B: Phase [-63 to +63]

The phase of B to Cy_B_B can be finely adjusted.

Return

Use this to return to the previous menu.

Camera menu items (continued)

■ System screen

This is the menu in which the camera's output image settings are configured.

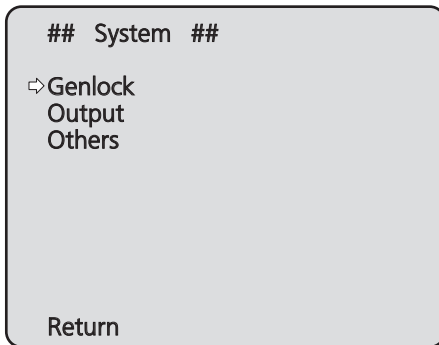

Genlock

This displays the Genlock screen on which to perform the phase adjustments.

Output

This displays the Output screen on which to select the camera's output image settings.

Others

This displays the Others screen on which to select the settings for the installation status of the camera's pan-tilt head unit and operating speed as well as the settings relating to the other functions.

Return

Use this to return to the previous menu.

■ Genlock screen

This unit supports BBS (Black Burst Sync) and tri-level synchronization.

External synchronization (genlock) can be applied to achieve phase alignment when multiple cameras are to be used or when the unit is to be used in combination with other devices.

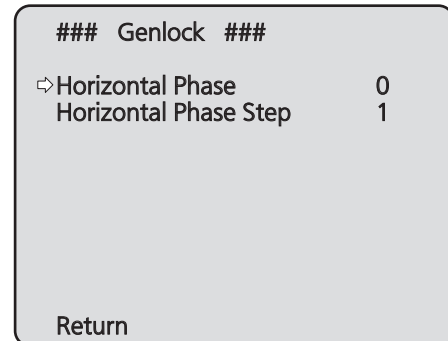

Horizontal Phase [-206 to +49]

This is used to adjust the horizontal phase during genlock.

Horizontal Phase Step [1 to 10]

This is selected to set the amount by which the [Horizontal Phase] setting is to be adjusted.

Return

Use this to return to the previous menu.

Notes

- When a cable is connected to the G/L IN connector and a valid synchronization signal is received, the following operations are temporarily halted.
 - Recording to an SD card
 - IP image transmission
 - Output from the HDMI terminal and SDI OUT connectors
 - Lens control
- The video signal of the SDI output may be temporarily distorted or may not be output in the following cases.
 - When the input signal to the G/L IN connector is disrupted or changed.
 - When a cable is connected to the G/L IN connector or disconnected.

Camera menu items (continued)

Output screen

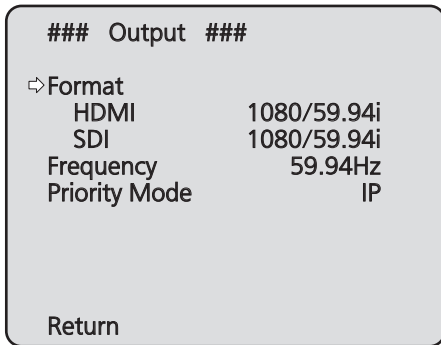

Format

HDMI, SDI

Format	Setting value	
	Frequency: 59.94Hz	Frequency: 50Hz
HDMI	Auto	Auto
	1080/59.94p	1080/50p
	1080/59.94i	1080/50i
	1080/29.97PsF	1080/25PsF
	1080/29.97p	1080/25p
	720/59.94p	720/50p
SDI	1080/59.94p	1080/50p
	1080/59.94i	1080/50i
	1080/29.97PsF	1080/25PsF
	1080/29.97p	1080/25p
	720/59.94p	720/50p

The video format is changed on this screen.
For details on how to change the format, refer to "Changing the format" (page 57).

Note

- The video signal of the SDI output may stop temporarily when the HDMI cable is disconnected and connected or the connected monitor is replaced, for example.

Simultaneous output according to video format

- Signals of the same video format are output from the HDMI and SDI OUT connectors. (The setting values in the menu will also change to match the format configured later.)
- When "HDMI" is set to "Auto", the unit automatically determines the output video resolution based on information from the connected device. This will result in the "SDI" setting changing to match the video format of "HDMI".

Frequency [59.94Hz, 50Hz]

This item is selected to switch the frame frequency.

- When the frequency is switched, "Format" is set as follows.

59.94Hz		50Hz
1080/59.94p	↔	1080/50p
1080/59.94i	↔	1080/50i
1080/29.97PsF	↔	1080/25PsF
1080/29.97p	↔	1080/25p
720/59.94p	↔	720/50p

- For details on how to change the frequency, see "Changing the frequency" (page 57).

Note

- If you change the frequency, the unit will restart automatically. Operation will not be possible while the unit is restarting. Some peripheral devices may not recognize that the unit has restarted. If you change the frequency, be sure to restart all peripheral devices.

Camera menu items (continued)

Priority Mode

[IP, SD card, USB, NDI|HX]

Configure the setting for the priority output of video.

IP:

Enables IP image transmission over multiple channels.
The IP transmission of H.264 images is also supported.

SD card:

Inserting an SD card (optional accessory) into the unit enables recording H.264 images to the SD card. The data recorded to the SD card can be played back on the Web screen, downloaded to a personal computer, and transferred to an FTP server.

USB:

Enables the unit to be used as a Web camera. The camera can also be controlled from a personal computer.

NDI|HX:

Transmits video to NewTek NDI compatible software applications and hardware devices over a network. The function supports H.264/IP transmission using NDI|HX.

Notes

- When the priority mode is changed, the operation of the mode before the change is forcefully stopped.
- The “IP” and “SD card” mode require various settings to be configured from a personal computer connected via the network.

Priority mode change confirmation screen

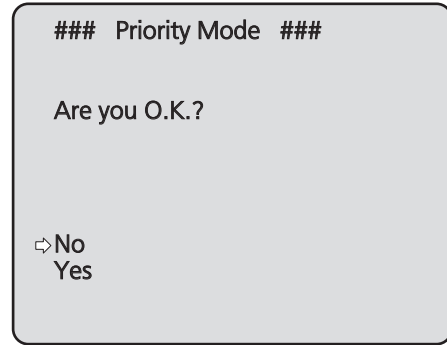

- If you move the cursor to “Yes” and confirm, the priority mode is changed and the display returns to the Output screen.
- If you move the cursor to “No” and confirm, the mode is set to the pre-change mode, and the display returns to the Output screen.

Return

Use this to return to the previous menu.

Camera menu items (continued)

● Changing the format

When the format is changed on the Output screen from its current setting, the pre-format-change confirmation screen appears.

Pre-format-change confirmation screen

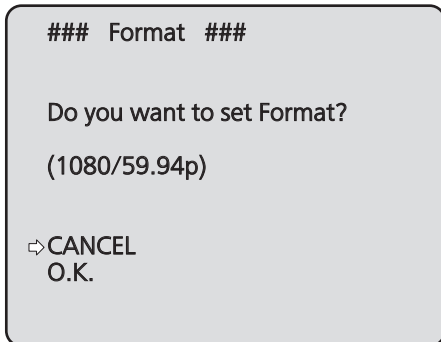

- The format to be set is displayed within the parentheses on the screen.

Field frequency	59.94 Hz	50 Hz
HDMI	Auto	Auto
	1080/59.94p	1080/50p
	1080/59.94i	1080/50i
	1080/29.97PsF	1080/25PsF
	1080/29.97p	1080/25p
SDI	720/59.94p	720/50p
	1080/59.94p	1080/50p
	1080/59.94i	1080/50i
	1080/29.97PsF	1080/25PsF
	1080/29.97p	1080/25p
	720/59.94p	720/50p

- When you move the cursor to “O.K.” on the pre-format-change confirmation screen and confirm, the format is changed, and then the post-format-change confirmation screen appears.

Post-format-change confirmation screen

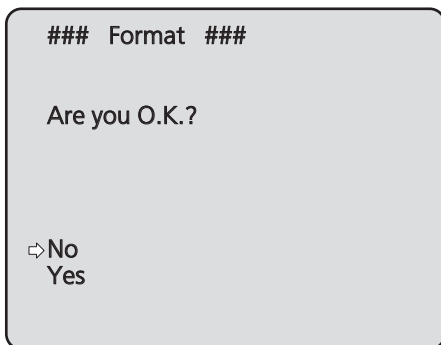

- If you move the cursor to “Yes” and confirm, the format is set to the post-change format, and the display returns to the Output screen.
- If you move the cursor to “No” and confirm, the format is set to the pre-change format, and the display returns to the Output screen. Similarly, the display will return to the Output screen if an operation is not performed within 30 seconds.

● Changing the frequency

When the currently selected frequency is changed in the Output screen, the frequency-change confirmation screen appears.

Note

- When using a monitor that does not support the 59.94 Hz or 50 Hz frequencies, images may not be output after the frequency is changed. Verify that the monitor supports the post-change frequency before changing the frequency.

Frequency-change confirmation screen

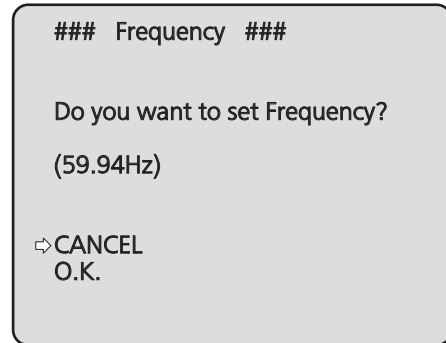

- The frequency to be set is displayed within the parentheses on the screen.
- When you move the cursor to “O.K.” on the frequency-change confirmation screen and confirm, the unit restarts and the Frequency Set screen appears for 5 seconds.

Frequency Set screen

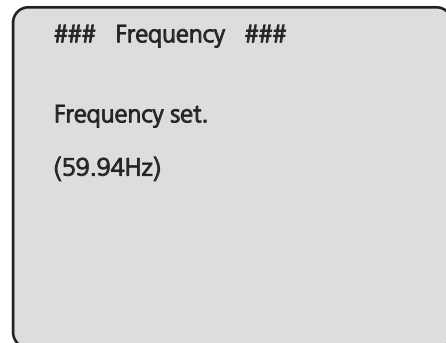

Camera menu items (continued)

Others 1/4 screen

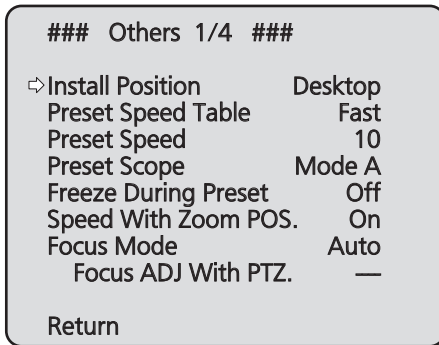

Install Position [Desktop, Hanging]

“Desktop” or “Hanging” is selected here as the method used to install the unit.

Desktop: Stand-alone installation

Hanging: Suspended installation

- When “Hanging” has been selected, the top, bottom, left and right of the images will be reversed, and up/down/left/right control for panning and tilting will also be reversed.

Preset Speed Table [Slow, Fast]

Set the preset speed table (Slow, Fast).

During preset playback, preset actions are performed at Preset Speed (1 to 30) values that are based on the table set here.

Slow: Set the preset speed table to “Slow”.

Fast: Set the preset speed table to “Fast”.

Preset Speed [1 to 30]

There are 30 preset pan-tilt operation speeds when regenerating the camera direction and other information which are registered in the preset memory.

Note

- If a high value is selected for the Preset Speed setting, the image on the screen may shake when operation stops.

Preset Scope [Mode A, Mode B, Mode C]

Selected here are the setting items to be recalled when the contents of the preset memory are regenerated.

Mode A: Pan, Tilt, Zoom (including digital zoom), Focus, Iris, Gain, White-BAL

Mode B: Pan, Tilt, Zoom (including digital zoom), Focus, Iris

Mode C: Pan, Tilt, Zoom (including digital zoom), Focus

Freeze During Preset [Off, On]

Turn the function for freezing images during preset playback Off/On.

When this is set to “On”, preset playback is performed with a still of the image immediately preceding the start of preset playback being output. The image freeze is released when preset playback is finished.

Notes

- When this is set to “On”, the start of preset operations may be delayed momentarily due to the image being frozen.
- When HDR is set to “Low” or “High”, this is set to “Off”.

Speed With Zoom POS. [Off, On]

“Off” or “On” is set here for the function used to adjust the camera direction’s adjustment speed in conjunction with the zoom magnification.

When “On” is set, the panning and tilting operations will become slower in the zoom status.

This function has no effect during preset operations.

Focus Mode [Auto, Manual]

“Auto” or “Manual” is set here for the focusing function.

Auto: The subjects are always brought into focus automatically.

Manual: The focus is operated manually.

Focus ADJ With PTZ. [Off, On]

“Off” or “On” is set here for the function which compensates for out-of-focusing when it occurs during panning, tilting or zooming operations at the manual focus setting.

This item can be selected only when “Manual” has been selected as the “Focus Mode” setting.

Return

Use this to return to the previous menu.

Camera menu items (continued)

Others 2/4 screen

### Others 2/4 ###	
Zoom Mode	D.Zoom
Max Digital Zoom	×12
D. Extender	Off
D. Extender Magnification	×8.0
OIS	Off
Tally	Enable
IR Control	Enable
IR ID	CAM1
Return	

Zoom Mode

[Opt.Zoom, i.Zoom, D.Zoom]

Configure the maximum zoom magnification.

Opt.Zoom: Use only the optical zoom. Up to 20× optical zoom is possible.

i.Zoom: Enable the i.Zoom function.
Enabling this function allows you to perform electronic zoom while reducing drops in picture quality.
Combining optical zoom and electronic zoom, up to 30× zoom is possible.

D.Zoom: Enable the digital zoom function.
Picture quality degrades as zoom increases with digital zoom.

Max Digital Zoom [×2 to ×12]

Set the maximum digital zoom magnification.
This is only enabled when Zoom Mode is set to “D.Zoom”.

D.Extender [Off, On]

Set the digital extender function Off/On.
When this function is enabled, the video magnification set with the “D. Extender Magnification” (digital zoom) is further increased. You can use this function to temporarily enlarge the image for confirmation of focus and such.

D.Extender Magnification

[×1.4, ×2.0, ×4.0, ×6.0, ×8.0]

Set the magnification for the digital extender function.

OIS [Off, Mode1, Mode2]

Set the optical image stabilization function.

Off: Image stabilization function not used.

Mode1: Image stabilization function used (optical, 2-axis compensation)

Mode2: Image stabilization function used (optical+electronic, 4-axis compensation)

Notes

- “Mode2” cannot be selected when HDR is “Low” or “High”.
- When “Mode2” is selected, the view angle changes to set aside image pixels for use during compensation.
- When “Mode2” is selected, display of the output image is delayed compared to the actual image.
- Although the image stabilization of “Mode2” (hybrid of optical and electronic compensation) produces stronger compensation than “Mode1”, depending on the shooting conditions, it may not be able to differentiate between movement of the subject and movement of the unit as it performs compensation (electronic) on movement detected in the video signal. Therefore, erroneous compensation may occur.
- The image stabilization setting cannot be changed while data is being written to the SD card.

Tally [Disable, Enable]

“Enable” or “Disable” is set here for the function which turns on or turns off the tally lamp using the tally control signal.

Camera menu items (continued)

IR Control [Disable, Enable]

“Enable” or “Disable” is set here for operations conducted from the wireless remote control.

The operations are enabled when the unit’s power is turned on from an external device other than a wireless remote control, and they are disabled when the power is turned on from a wireless remote control.

Notes

- At the point when this item’s setting is changed, the new setting is not reflected in operation. It is reflected when the unit is set to standby mode and its power is turned on.
- Follow one of the procedures below if the item’s setting is changed by mistake and the unit can no longer be operated from a wireless remote control.
When menu operations can be performed using another control device:
→ First change the item using a control device capable of performing menu operations, and then turn off the unit’s power and turn it back on.
When menu operations cannot be performed using other control devices:
 1. Turn off the power of the units and devices that are connected.
 2. Disconnect the unit’s AC adaptor cable and LAN cable, and plug them back in.
 3. Perform the operation for turning on the unit’s power from the wireless remote control.
 4. After changing this item, turn off the unit’s power and turn it back on.

IR ID

[CAM1, CAM2, CAM3, CAM4]

Configure the unit’s remote control ID.

The settings for this item correspond to the [CAM1] to [CAM4] buttons on the wireless remote control.

Return

Use this to return to the previous menu.

Others 3/4 screen

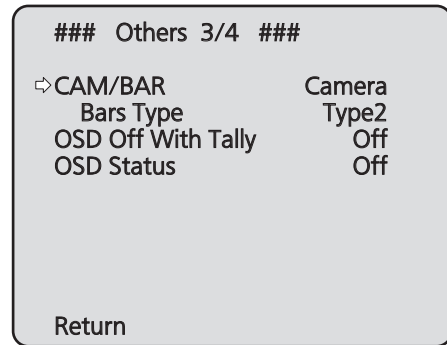

CAM/BAR [Camera, Colorbar]

Switch between color bar display and camera image display on the monitor and the web setup screen.

Note

- When the color bar is displayed, a test tone (1 kHz) is output according to the Audio setting in the camera menu.

Bars Type [Type1, Type2]

Change the type of color bar to display.



OSD Off With Tally [Off, On]

This is used to enable or disable the function for clearing the OSD menu displays when the tally signal is received by a command or contact.

When the tally signal is released, the original OSD menu displays are restored.

OSD Status [Off, On]

“Off” or “On” is set here for the status display which appears during AWB operations.

Return

Use this to return to the previous menu.

Camera menu items (continued)

Others 4/4 screen

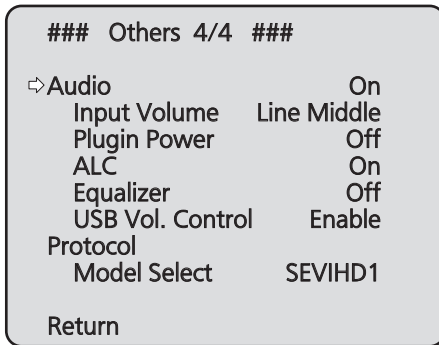

Audio [Off, On]

Enable/disable the audio input signal from the device connected to the audio input connector.

Input Volume

[Mic High, Mic Middle, Mic Low, Line High, Line Middle, Line Low]

Set the mic input, line input, and volume.

Mic High:

Use the mic input with the volume set to high.

Mic Middle:

Use the mic input with the volume set to medium.

Mic Low:

Use the mic input with the volume set to low.

Line High:

Use the line input with the volume set to high.

Line Middle:

Use the line input with the volume set to medium.

Line Low:

Use the line input with the volume set to low.

Plugin Power [Off, On]

Turn the plugin power for the audio Off/On.

ALC [Off, On]

Turn automatic level adjustment for the audio Off/On.

Equalizer

[Off, Low Cut, Speech Enhancement]

Set the equalizer function.

Off:

Do not use the equalizer function.

Low Cut:

Cut low frequencies to reduce the noise of an air-conditioning unit, projector, or other equipment.

Speech Enhancement:

Cut low frequencies and high frequencies to enhance the clarity of speech.

USB Vol. Control [Disable, Enable]

Enable/disable control of the volume (page 130) with communication software when the unit is used as a Web camera.

Disable:

Disable control of the volume with communication software.

Enable:

Enable control of the volume with communication software.

Note

- When set to [Enable], the volume controls on the communication software change the volume on the unit. Audio may not be stable depending on the combination of the unit and communication software. Set to [Disable] if this is the case.

Protocol Model Select

[SEVIHD1, SBRC300, SBRCZ330, Reserved1 to 7]

Set the protocol model for standard serial communication. Do not select "Reserved1" to "Reserved7".

Return

Use this to return to the previous menu.

Camera menu items (continued)

■ Maintenance screen

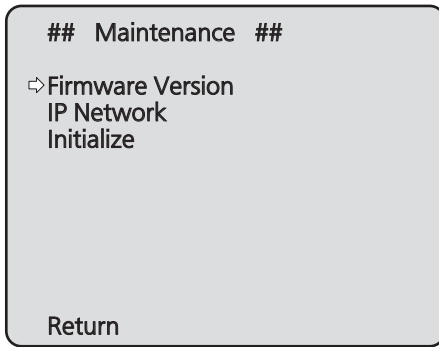

Firmware Version

This is selected to display the Firmware Version screen on which to check the version of the firmware used.

IP Network

This is selected to display the IP Network screen on which the user can check the IP Address, Subnet Mask and Default Gateway settings which have been established in the unit.

Initialize

This is selected to display the Initialize screen on which the user can initialize the camera settings.
For details on operation, refer to “Concerning initialization” on page 63.

Return

Use this to return to the previous menu.

■ Firmware Version screen

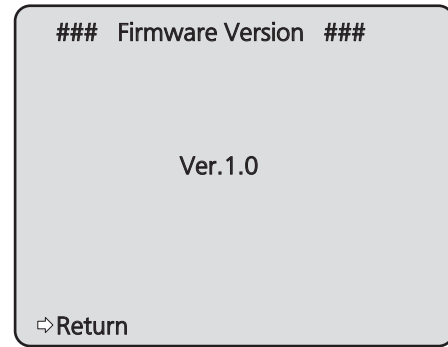

This displays the unit's firmware version.

Return

Use this to return to the previous menu.

Camera menu items (continued)

■ IP Network screen

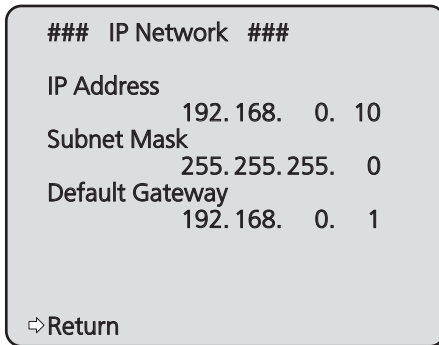

IP Address

This is selected to display the IP address which has been set for the unit.

Subnet Mask

This is selected to display the subnet mask which has been set for the unit.

Default Gateway

This is selected to display the default gateway which has been set for the unit.

Note

- On this screen, the IP Address, Subnet Mask and Default Gateway settings can be displayed but they cannot be changed. To change an address, use “Network setup screen [Network]” (page 103) on the Web setting screen or “Use the Easy IP Setup Software to establish the unit’s settings” (page 25).

Return

Use this to return to the previous menu.

● Concerning initialization

When “Initialize” is selected on the Maintenance screen, the Initialize screen appears.

Initialize screen

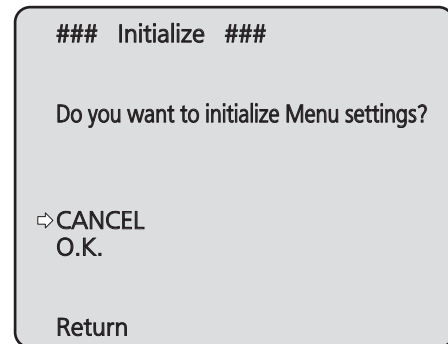

- When the cursor is moved to “O.K.” on the Initialize screen and the setting is entered, the Menu settings initialized screen is displayed for 5 seconds, and the camera settings are restored to the settings which were established when the camera was purchased (“Camera menu item table” (pages 64 to 66)). However, the Format settings and Frequency settings (page 55) and network settings are not initialized. When the initialization operation is completed, the Initialize screen is restored to the display.
- The settings of the priority mode (page 56, page 77) are not initialized.

Menu settings initialized screen

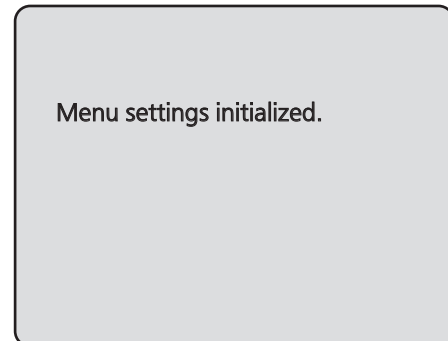

- When the cursor is moved to “CANCEL” on the Initialize screen and the setting is entered, the Menu settings unchanged screen is displayed for 5 seconds, the initialization operation is not performed, and the Initialize screen returns to the display.

Menu settings unchanged screen

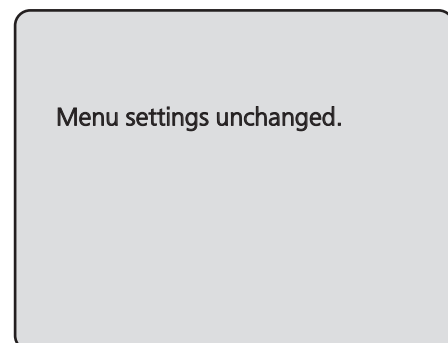

Camera menu item table

Camera menu			Item	Factory setting		Selection items		
				Full Auto	Manual1 to 3			
Top Menu	Camera	Scene	Scene	Full Auto	Manual1 to Manual3	Full Auto, Manual1, Manual2, Manual3		
			Contrast 1/2	Contrast Mode	----	Auto	Auto, Manual	
				Contrast Level	0	0	-10 to +10	
				Auto Shutter Limit	----	Off	<ul style="list-style-type: none"> When 59.94 Hz is selected: Off, 1/60, 1/100, 1/120, 1/250 When 50 Hz is selected: Off, 1/50, 1/100, 1/125, 1/250 	
				Shutter Mode	----	Off	Off, Step, Synchro	
				Step/Synchro (When "Step" is selected as the "Shutter Mode")	----	[59.94Hz] 1/100 [50Hz] 1/120	<ul style="list-style-type: none"> When 59.94 Hz is selected: 1/100, 1/250, 1/500, 1/1000, 1/2000, 1/4000, 1/10000 When 50 Hz is selected: 1/120, 1/250, 1/500, 1/1000, 1/2000, 1/4000, 1/10000 	
				Step/Synchro (When "Synchro" is selected as the "Shutter Mode")	----	[59.94Hz] 59.94Hz [50Hz] 50.00Hz	<ul style="list-style-type: none"> When 59.94 Hz is selected: 59.94Hz to 660.09Hz (255 steps) When 50 Hz is selected: 50.00Hz to 570.12Hz (255 steps) 	
				Frame Mix	----	Auto	Auto, Off, 6dB, 12dB, 18dB, 24dB	
				Auto F.Mix Max Gain	----	0dB	0dB, 6dB, 12dB, 18dB	
				Contrast 2/2	Gain	----	Auto	Auto, 0dB to 48dB (3dB increments)
					AGC Max Gain	----	24dB	6dB to 48dB (6dB increments)
			ND Filter		Through	Through	Through, 1/4, 1/16, 1/64	
			Day/Night		Day	Day	Day, Night, Auto	
			Night-Day Level		Mid	Mid	Low, Mid, High	
			Picture	Picture 1/3	Chroma Level	----	+2	-3 to +3
					White Balance Mode	----	Manual1: ATW Manual2: AWB A Manual3: AWB B	ATW, AWB A, AWB B, 3200K, 5600K, VAR
					Color Temperature	----	3200K	2400K to 9900K (approx. 100K increments)
					R Gain	----	0	-30 to +30
					B Gain	----	0	-30 to +30
					Pedestal	----	0	-10 to +10
					Picture 2/3	Detail	----	Low
				Detail Level H		----	18	Detail Level L setting +1 to 18
				Detail Level L		----	9	1 to Detail Level H setting -1
				Flesh Tone Mode		----	Off	Off, Low, High
				HDR		----	Off	Off, Low, High
				DRS		----	Off	Off, Low, High
				E.DRS		----	Off	Off, Low, High
				Picture 3/3	Gamma Type	----	Normal	Off, Normal, Cinema
					Gamma Level	----	Mid	Low, Mid, High
					Back Light COMP.	----	Off	Off, On
					DNR	----	Low	Off, Low, High
			Matrix	Matrix 1/3	Matrix Type	----	Normal	Normal, EBU, NTSC, User
					B Saturation	----	0	-31 to +31
					B Phase	----	0	-63 to +63
					B_B_Mg Saturation	----	0	-31 to +31
					B_B_Mg Phase	----	0	-63 to +63
					B_Mg_Mg Saturation	----	0	-31 to +31
					B_Mg_Mg Phase	----	0	-63 to +63
					Mg Saturation	----	0	-31 to +31
					Mg Phase	----	0	-63 to +63
					Mg_R Saturation	----	0	-31 to +31
					Mg_R Phase	----	0	-63 to +63
					R Saturation	----	0	-31 to +31
					R Phase	----	0	-63 to +63

Camera menu item table (continued)

Camera menu					Item	Factory setting		Selection items	
						Full Auto	Manual1 to 3		
Top Menu	Camera	Scene	Matrix	Matrix 2/3	Matrix Type	----	Normal	Normal, EBU, NTSC, User	
					R_R_YI Saturation	----	0	-31 to +31	
					Phase	----	0	-63 to +63	
					R_YI_YI Saturation	----	0	-31 to +31	
					Phase	----	0	-63 to +63	
					YI Saturation	----	0	-31 to +31	
					Phase	----	0	-63 to +63	
					YI_YI_G Saturation	----	0	-31 to +31	
					Phase	----	0	-63 to +63	
					YI_G_G Saturation	----	0	-31 to +31	
					Phase	----	0	-63 to +63	
					G Saturation	----	0	-31 to +31	
				Phase	----	0	-63 to +63		
				Matrix 3/3	Matrix Type	----	Normal	Normal, EBU, NTSC, User	
					G_Cy Saturation	----	0	-31 to +31	
					Phase	----	0	-63 to +63	
					Cy Saturation	----	0	-31 to +31	
					Phase	----	0	-63 to +63	
	Cy_Cy_B Saturation	----	0		-31 to +31				
	Phase	----	0	-63 to +63					
	Cy_B_B Saturation	----	0	-31 to +31					
	Phase	----	0	-63 to +63					
	System	Genlock			Horizontal Phase	0		-206 to +49	
					Horizontal Phase Step	1		1 to 10	
					Output	Format HDMI	[59.94Hz]	Auto	Auto, 1080/59.94p, 1080/59.94i, 1080/29.97PsF, 1080/29.97p, 720/59.94p
							[50Hz]	Auto	Auto, 1080/50p, 1080/50i, 1080/25PsF, 1080/25p, 720/50p
						Format SDI	[59.94Hz]	1080/59.94i	1080/59.94p, 1080/59.94i, 1080/29.97PsF, 1080/29.97p, 720/59.94p
							[50Hz]	1080/50i	1080/50p, 1080/50i, 1080/25PsF, 1080/25p, 720/50p
Frequency		AW-HE42WP, AW-HE42KP: 59.94Hz AW-HE42WE, AW-HE42KE: 50Hz		59.94Hz, 50Hz					
Priority Mode		IP		IP, SD card, USB, NDI HX					
Others		Others 1/4			Install Position	Desktop		Desktop, Hanging	
					Preset Speed Table	Fast		Slow, Fast	
					Preset Speed	10		1 to 30	
					Preset Scope	Mode A		Mode A, Mode B, Mode C	
					Freeze During Preset	Off		Off, On	
					Speed With Zoom POS.	On		Off, On	
					Focus Mode	Auto		Auto, Manual	
					Focus ADJ With PTZ.	Off		Off, On	
		Others 2/4				Zoom Mode	i.Zoom		Opt.Zoom, i.Zoom, D.Zoom
						Max Digital Zoom	×12		×2 to ×12
						D. Extender	Off		Off, On
						D. Extender Magnification	×1.4		×1.4, ×2.0, ×4.0, ×6.0, ×8.0
						OIS	Off		Off, Mode1, Mode2
						Tally	Enable		Disable, Enable
	Others 3/4				IR Control	Enable		Disable, Enable	
					IR ID	CAM1		CAM1, CAM2, CAM3, CAM4	
CAM/BAR					Camera		Camera, Colorbar		
Bars Type					Type2		Type1, Type2		
OSD Off With Tally	Off		Off, On						
OSD Status	Off		Off, On						

Camera menu item table (continued)

Camera menu				Item	Factory setting		Selection items
					Full Auto	Manual1 to 3	
Top Menu	System	Others	Others 4/4	Audio	Off		Off, On
				Input Volume	Line Middle		Mic High, Mic Middle, Mic Low, Line High, Line Middle, Line Low
				Plugin Power	Off		Off, On
				ALC	On		Off, On
				Equalizer	Off		Off, Low Cut, Speech Enhancement
				USB Vol. Control	Enable		Disable, Enable
				Protocol			
				Model Select	SEVIHD1		SEVIHD1, SBRC300, SBRCZ330, Reserved1, Reserved2, Reserved3, Reserved4, Reserved5, Reserved6, Reserved7
	Maintenance			Firmware Version	----	Version shipped	----
				IP Network	IP Address	192.168.0.10	----
					Subnet Mask	255.255.255.0	----
					Default Gateway	192.168.0.1	----
				Initialize	----	CANCEL	CANCEL, OK

Displaying the web screen

With a personal computer connected to the unit, it is possible to view the camera's IP videos or select various settings from the web browser.

Select an IP address for the personal computer within the private address range while ensuring that it is different from the address of the unit. Set the subnet mask to the same address as the unit.

Unit's IP address and subnet mask (factory settings)*1

IP address: 192.168.0.10

Subnet mask: 255.255.255.0

*1 The factory default for the private address range is between 192.168.0.1 and 192.168.0.255.

- If the controller and web browser are being used at the same time, the content selected using the controller may not be reflected on the web browser display. When using both the controller and web browser, be absolutely sure to check the settings using the controller or camera menu.

For details of the required personal computer environment, refer to page 11.

Notes

- Some functions on the web setting screen can be used only from a personal computer which is running Windows. (They cannot be used from a personal computer which is running OS X (Mac).)
- The "Network Camera View 4S" plug-in viewer software must have already been installed in order to display the unit's IP videos using a personal computer which is running Windows. (This is not required for a personal computer which is running OS X (Mac).) For further details, refer to "Installing the plug-in viewer software" (page 26).

Displaying the web screen using a personal computer

The procedure is explained here using Windows screens (Internet Explorer), but it is the same when using the Mac (Safari)*2 screens.

*2 There may be differences in some parts of the screen displays.

1. Start the web browser of the personal computer.

Operating system installed	Web browser
Windows	Internet Explorer
OS X (Mac)	Safari

2. Enter the IP address you configured on the Easy IP Setup Software in the address bar of the web browser.

IPv4 address entry example:

http://URL registered with IPv4 address

http://192.168.0.10/



IPv6 address entry example:

http://[URL registered with IPv6 address]

http://[2001:db8::10]/



Note

- If the HTTP port number has been changed from "80", enter "http://<camera IP address>:<port number>" in the address bar. Example: When the port number is set to 8080 : http://192.168.0.11:8080

3. Press the [Enter] key.

The web screen appears.

The live screen [Live] (page 69) is displayed initially. You can switch to the web setup screen [Setup] (page 76) when necessary. (page 68)



Displaying the web screen (continued)

Note

- If the personal computer does not have the plug-in viewer software already installed, an installation confirmation message is displayed before the live screen [Live] is displayed. In a case like this, follow the on-screen instructions to install the software. [Windows](#)
For further details, refer to “Installing the plug-in viewer software” (page 26).

Notes

- When an attempt is made to display multiple H.264 images on one personal computer, IP videos may not be displayed depending on the performance of the personal computer concerned. [Windows](#)
- Up to 14 users (consisting of users receiving H.264 images and users receiving JPEG images) can access the unit at the same time. However, the number of users that can access the unit may be less than 14 depending on the settings. When [Transmission type] is set to [Multicast] for [H.264], the second and subsequent users receiving H.264 images will not be counted toward the total access count.
- The image refresh speed may become slower depending on the network environment, performance of your computer, subject, number of accesses, and settings configured.
- When the shooting scenes vary significantly, restrictions imposed by the graphics processing (GDI) of the operating system installed may give rise to a phenomenon called “screen tearing” (where parts of the picture are not displayed in synchronization) although this will depend on the personal computer used.
- On a personal computer running Windows, if [H.264 transmission] (page 81) is set to [On], H.264 images and JPEG images can be displayed. When it is set to [Off], only JPEG images will appear. When [H.264 transmission] and [JPEG transmission] are all set to [Off], a black JPEG screen is displayed.
- On a personal computer running OS X (Mac), regardless of the [H.264 transmission] settings, only JPEG images will appear. (H.264 images will not appear.)

Switching between the Live screen [Live] and Web setup screen [Setup]

When the live screen [Live] is displayed, click the [Setup] button .

For details on the web setup screen [Setup], see “Logging into the Web setup screen [Setup]” (page 75).

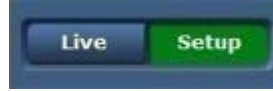

When the web setup screen [Setup] is displayed, click the [Live] button .

For details on the live screen [Live], see “Live screen [Live]” (page 69, page 74).

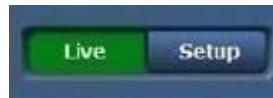

Notes

- During Standby mode, the [Setup] button is disabled, and you cannot switch to the web setup screen [Setup].
- If the unit is switched to Standby mode from another terminal while the web setup screen [Setup] is displayed, the display will automatically switch to the live screen [Live] after a few seconds.

Web screen operations

The live screen [Live] includes a “single display mode” that displays IP images from a single camera and a “multi display mode” that displays IP images from multiple cameras. See below for details on the “single display mode”, and see page 74 for details on the “multi display mode”.

Live screen [Live] : Single display mode

You can display images from the camera on a personal computer and perform camera operations, such as pan, tilt, zoom, and focus control.

The items displayed on the screen will differ depending on whether the [H.264] or [JPEG] button is selected under [Compression].

When [H.264] is selected Windows

(Other menu) (Stream menu)

When [JPEG] is selected

(Other menu) (Stream menu)

Web screen operations (continued)

1. Menu switching [Other Menu >>] / [Stream Menu >>]

Switch between menu displays.
 Clicking [Other Menu >>] when the Stream menu is displayed displays the Other menu.
 Clicking [Stream Menu >>] when the Other menu is displayed displays the Stream menu.

- The Stream menu is always displayed when the web screen is updated and the Live screen is displayed from another screen. However, this is not the case when recording to an SD card.

2. Multi-Screen list box [Multi-screen]

The live screen [Live] display method is selected here.

<div style="border: 1px solid black; padding: 2px;">Single</div> <div style="border: 1px solid black; padding: 2px;">[Single]</div>	The IP videos of the connected camera are displayed.
<div style="border: 1px solid black; padding: 2px;">4Split 1/4 Group</div> <div style="border: 1px solid black; padding: 2px;">[4Split 1/4 Group]</div>	You can view multiple IP videos on a single screen by configuring the cameras for multi-screen display beforehand in the Multi screen setup screen [Multi-screen] (page 100). (Multi display mode)
<div style="border: 1px solid black; padding: 2px;">4Split 2/4 Group</div> <div style="border: 1px solid black; padding: 2px;">[4Split 2/4 Group]</div>	
<div style="border: 1px solid black; padding: 2px;">4Split 3/4 Group</div> <div style="border: 1px solid black; padding: 2px;">[4Split 3/4 Group]</div>	
<div style="border: 1px solid black; padding: 2px;">4Split 4/4 Group</div> <div style="border: 1px solid black; padding: 2px;">[4Split 4/4 Group]</div>	
<div style="border: 1px solid black; padding: 2px;">16Split</div> <div style="border: 1px solid black; padding: 2px;">[16Split]</div>	

3. Compression buttons [Compression]

<div style="border: 1px solid black; padding: 2px; background-color: #333; color: white; text-align: center;">H.264</div> <div style="border: 1px solid black; padding: 2px;">[H.264]</div>	When selected, the text on the button turns green, and H.264 images are displayed. Windows The [H.264] button is enabled when the [H.264 transmission] setting of [H.264 (1)] to [H.264 (4)] on the Video over IP is [On]. (page 81)
<div style="border: 1px solid black; padding: 2px; background-color: #333; color: white; text-align: center;">JPEG</div> <div style="border: 1px solid black; padding: 2px;">[JPEG]</div>	When selected, the text on the button turns green, and JPEG images are displayed.

Note

- In the following cases, the selection status of the [Compression] buttons will return to the setting configured in the [Video over IP] tab - [Initial display settings for "Live" page] - [Stream]. [Windows](#)
 - When returning from another screen
 - When the screen is updated

4. Stream buttons [Stream]

When [H.264] is selected [Windows](#)

These buttons appear only when H.264 images are displayed.

<div style="border: 1px solid black; padding: 2px; background-color: #333; color: white; text-align: center;">1</div> <div style="border: 1px solid black; padding: 2px;">[1]</div>	When selected, the text on the button turns green, and the images in the main area appear according to the settings configured for [H.264(1)]. (page 81)
<div style="border: 1px solid black; padding: 2px; background-color: #333; color: white; text-align: center;">2</div> <div style="border: 1px solid black; padding: 2px;">[2]</div>	When selected, the text on the button turns green, and the images in the main area appear according to the settings configured for [H.264(2)]. (page 81)
<div style="border: 1px solid black; padding: 2px; background-color: #333; color: white; text-align: center;">3</div> <div style="border: 1px solid black; padding: 2px;">[3]</div>	When selected, the text on the button turns green, and the images in the main area appear according to the settings configured for [H.264(3)]. (page 81)
<div style="border: 1px solid black; padding: 2px; background-color: #333; color: white; text-align: center;">4</div> <div style="border: 1px solid black; padding: 2px;">[4]</div>	When selected, the text on the button turns green, and the images in the main area appear according to the settings configured for [H.264(4)]. (page 81)

Notes

- In the following cases, the selection status of the [Stream] buttons will return to the setting configured in the [Video over IP] tab - [Initial display settings for "Live" page] - [Stream]. [Windows](#)
 - When returning from another screen
 - When the screen is updated
- The selected H.264 image may be reduced to a size smaller than actual size depending on the size of the Web browser window.



When [JPEG] is selected

<div style="border: 1px solid black; padding: 2px; background-color: #333; color: white; text-align: center;">1</div> <div style="border: 1px solid black; padding: 2px;">[1]</div>	When selected, the text on the button turns green, and the images in the main area appear according to the settings configured for [JPEG(1)]. (page 81)
<div style="border: 1px solid black; padding: 2px; background-color: #333; color: white; text-align: center;">2</div> <div style="border: 1px solid black; padding: 2px;">[2]</div>	When selected, the text on the button turns green, and the images in the main area appear according to the settings configured for [JPEG(2)]. (page 81)
<div style="border: 1px solid black; padding: 2px; background-color: #333; color: white; text-align: center;">3</div> <div style="border: 1px solid black; padding: 2px;">[3]</div>	When selected, the text on the button turns green, and the images in the main area appear according to the settings configured for [JPEG(3)]. (page 81)



Web screen operations (continued)

5. SD Card Operation buttons [SD Card Operation]

Perform the operations for recording the video and audio captured with the unit to an SD card.

 [Rec]	Starts recording to an SD card. The SD access lamp on the top right of the screen is displayed in red during recording.
 [Stop]	Stops recording to an SD card.
 [Play List]	Displays a list of the recorded content.



6. OSD Menu Operation [OSD Menu Operation]

 [On / Off]	Use this to select whether the camera's on-screen displays are to be shown.
 [Cancel]	It cancels the selection of the setting which is being changed. It restores the pre-change setting.
 [←/→/↑/↓/OK]	Use these to perform the menu operations. The items are selected using the [←/→/↑/↓] buttons. If a selected item has a sub menu, this sub menu is displayed by pressing the [OK] button. When the cursor is moved to any item on the bottom-level setting screen and the [OK] button is pressed, the setting of the selected item starts flashing. A setting for a regular menu item is reflected immediately if it is changed while it is still flashing. However, there are a number of menu items (Scene, Format and Initialize) whose setting is reflected only after the [OK] button has been pressed, causing the setting to stop flashing and the new setting to be entered.

Note

- If OSD menu display is set to "On" by Web screen operation, the OSD menu is also displayed for the monitor video.

7. Power ON button [Power ON] / Standby button [Standby]

 [Power ON]	Turn the unit on.
 [Standby]	Set the unit to Standby mode.

In the Standby mode, all the buttons on the live screen [Live] except for the [Multi-screen] list box, [Power ON] button, [Standby] button and [Op. Lock] button are disabled.

Notes

- If [Power ON] or [Standby] is selected too quickly, the status selected and the display shown may not correspond. In a case like this, follow the steps below to restore the correct status display:
For Windows:
Press the [F5] key on the keyboard of the personal computer.
For Mac:
Press the [Command] + [R] keys on the keyboard of the personal computer.
- **When operation is transferred to the Standby mode:**
The current pan/tilt and zoom positions are stored in the memory (Power ON preset).
- **When operation is transferred to the Power ON mode:**
The pan/tilt and zoom are adjusted to the positions which were stored in the memory (Power ON preset) when operation was transferred to the Standby mode.

8. Operation lock button [Op. Lock]

 [Op. Lock]	Use this to lock the operation of the pan, tilt, zoom, focus, brightness, speed, preset and scene operations on the control screen. Use this also to lock the Other menu operations and [Power ON] button / [Standby] button to prevent operations from being performed by accident.
---	--

Web screen operations (continued)

9. Main area (IP video display area)







The IP video of the connected camera will be displayed. While the tally lamp is on (except during recording), the area frame will turn red. When the tally lamp is off, the display area will return to normal. Operating the mouse wheel inside the display area allows you to use the plug-in viewer software's digital zoom.

[Windows](#)





Note

- When [Disable] is selected for [Tally] (page 59, page 99), the camera's tally lamp will not light even when the tally signal is input. However, the area frame of the main area (IP video display area) will turn red.

10.Zoom [Zoom]

 [D-Ext.]	Use this to enable or disable the digital extender.
 [x1.0]	Use this to adjust the zoom (magnification) to 1.0x.
 [-]	Use this to adjust the zoom (magnification) in the Wide direction.
 [+]	Use this to adjust the zoom (magnification) in the Tele direction.

11.Focus [Focus]

 [Auto]	Use this to switch between auto and manual focusing. When Auto is selected, the focus is adjusted automatically.
 [Near]	Use this to adjust the focus in the Near direction. It does not work during automatic adjustments.
 [O.T. AF]	When this is pressed while the focus is being adjusted manually, the focus will be temporarily adjusted automatically. It does not work during automatic adjustments.
 [Far]	Use this to adjust the focus in the Far direction. It does not work during automatic adjustments.

12.Control pad and its buttons



To adjust the image in the horizontal or vertical direction (panning or tilting), left-click the pad and the buttons. The more the outside of the pad is clicked, the faster the camera operates. Adjustment is also possible by dragging the mouse.

Right-click the pad to initiate zooming and focusing.

When the top half of the pad is clicked in the up or down direction, the zoom (magnification) is adjusted in the Tele direction; conversely, when the bottom half of the pad is clicked, the zoom is adjusted in the Wide direction.



When the left half of the pad is clicked in the left or right direction, the focus is adjusted in the Near direction; conversely when the right half of the pad is clicked, the focus is adjusted in the Far direction.

The zooming can also be adjusted by operating the mouse wheel.

Note

- When the mouse is used for dragging and dropping from the control pad area to a position outside this area, the panning, tilting and other operations will not stop. In a case like this, click the control pad area to stop these operations.

13.Brightness [Brightness]



 [-]	Use this to make the image darker. It does not work during automatic adjustments.
 [+]	Use this to make the image lighter. It does not work during automatic adjustments.
 [Auto]	Use this to switch the brightness adjustment between auto and manual. When Auto is selected, the picture brightness is adjusted automatically.

14.Speed [Speed]



 [Slow]	Use this to select the speed at which the pan, tilt, zoom and focus operations are to be performed.
---	---

Web screen operations (continued)

15.Preset [Preset]

 [Home]	When the Web screen is open, this is blank. When the preset position is selected from the pull-down menu and the [Move] button is clicked, the camera direction moves to the preset position which was registered ahead of time. Preset positions are registered on the preset position screen.
 [Move]	The camera direction moves to the preset position which is now selected on the pull-down menu. The settings that are reproduced at this position are the settings which were established on the [Preset Scope] menu (page 58, page 95, page 97). The camera direction moves to the home position if [Home] has been selected on the pull-down menu. In such cases, the image output during movement to the home position will not freeze, regardless of the [Freeze During Preset] setting.

16.Scene [Scene]

 [Scene1]	Select a shooting mode from the pull-down menu, and click the [Set] button to switch to the selected mode.
 [Set]	The shooting mode switches to the one selected in the pull-down menu.

17.Full-screen display button Windows

	Display the image in full-screen mode. When the image displayed in the main area is compressed, clicking this once displays the image at the correct resolution in the main area. When the image is displayed at the correct resolution, the image is displayed in full-screen mode. To return to the Live screen, press the [Esc] key on the personal computer while the image is displayed in full-screen mode. The aspect ratio of the displayed image will be adjusted according to the monitor size.
---	---



18.Snapshot button Windows

	Capture a snapshot (single still image), and display it in a separate window. A menu appears when you right-click the image, and you can select [Save] to save the image to the personal computer. You can also click [Print] to output from a printer.
---	---

Notes

- The following settings may be necessary. In the Internet Explorer menu bar, click [Tools] - [Internet Options] - [Security] tab, select [Trusted Sites], and then click [Sites]. Register the camera's address under [Websites] in the window that appears.
- Depending on the network environment, for example, if snapshot capture takes longer than a certain amount of time, the image may not appear.

19.Audio button Windows

	Turn the audio On/Off. (page 61, page 87) When you click this button, the button display changes to  , and audio from the unit cannot be heard from the personal computer. Move the cursor  to adjust the volume to the one of three levels: low, medium, and high.
---	---

20.SD access lamp [SD]

When an SD card is being accessed, this lamp is displayed in red.

21.Date and time indication

Displays the date and time set on the unit. ("Clock settings tab [Date&Time]" on page 77)

Note

- Deviation of time display may result when the date and time are displayed for a long time. In such cases, update the Web screen or display some other screen for a moment before redisplaying the Live screen.

22.Connected device indication

Displays "HD Integrated Camera AW-HE42".

23.Camera title display area

The name for the unit configured in the Basic screen [Basic] (page 78) appears.

Web screen operations (continued)

Live screen [Live] : Multi display mode

In this mode, the images of a multiple number of cameras can be monitored on one screen (called the 'multi screen'). The image of 4 cameras or max. 16 cameras can be monitored at one time. When the camera title of any of the images is clicked, the live screen [Live] (single display mode) of the camera concerned is displayed as a separate window. In order to use the multi screen, the cameras whose images are to be shown on the multi screen must be set ahead of time. With one group consisting of 4 cameras, up to four groups of cameras (a total of 16 cameras) can be registered. (page 100)

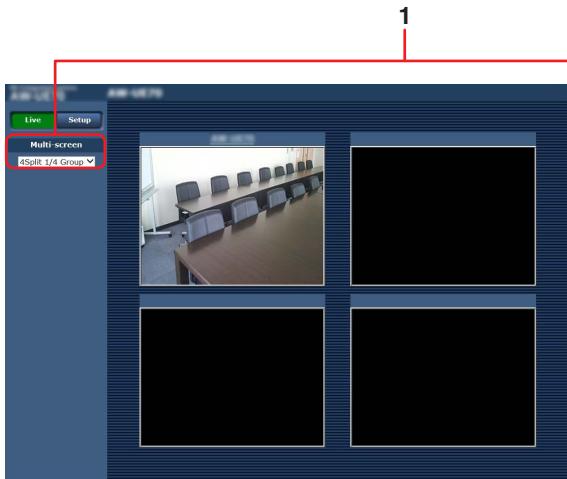

Multi screen consisting of 4 sub-screens

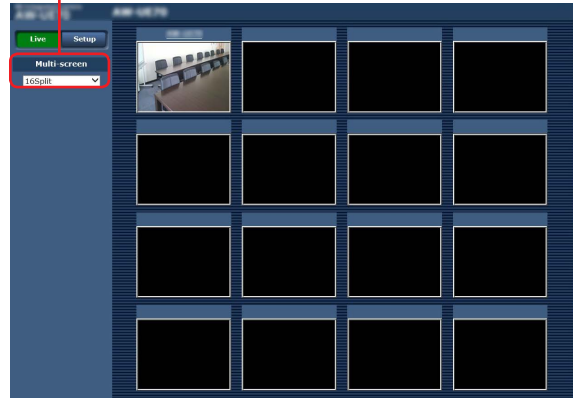

Multi screen consisting of 16 sub-screens

1. Multi-Screen list box [Multi-screen]

The live screen [Live] display method is selected here.

<div style="border: 1px solid black; padding: 2px;"> Single ▾ [Single] </div>	The IP videos of the connected camera are displayed. You can view multiple IP videos on a single screen by configuring the cameras for multi-screen display beforehand in the Multi screen setup screen [Multi-screen] (page 100). (Multi display mode)
<div style="border: 1px solid black; padding: 2px;"> 4Split 1/4 Group ▾ [4Split 1/4 Group] </div>	
<div style="border: 1px solid black; padding: 2px;"> 4Split 2/4 Group ▾ [4Split 2/4 Group] </div>	
<div style="border: 1px solid black; padding: 2px;"> 4Split 3/4 Group ▾ [4Split 3/4 Group] </div>	
<div style="border: 1px solid black; padding: 2px;"> 4Split 4/4 Group ▾ [4Split 4/4 Group] </div>	
<div style="border: 1px solid black; padding: 2px;"> 16Split ▾ [16Split] </div>	

Notes

- The IP videos displayed on the multi screen are JPEG images only.
- IP images are in JPEG format only and audio is not output.
- Images are stretched vertically to fit the [4:3] aspect ratio of the multi screens.
- It is not possible to transfer from the live screen [Live] to the multi screen if the unit's power has been turned off, or the network cable has been disconnected, while IP videos are being displayed.

Web screen configurations

Logging into the Web setup screen [Setup]

1. Turn on the power of the unit from the standby mode state.

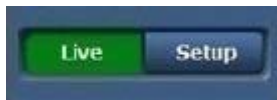

2. Click the [Setup] button. (page 68)

The login screen appears.



3. Enter the user name and password.

The factory settings for the user name and password are as follows.

User name	admin
Password	12345

4. Click the [OK] button.

Click [OK] again when the following screen appears.

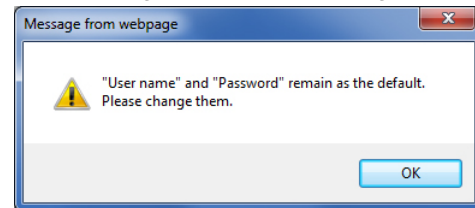

Notes

- While the initial settings remain used for the user name and password, a message prompting the user to change the user name and password is displayed after authorization. In order to ensure security, the password for the user name of "admin" must be changed without fail. It is also recommended that the password be changed at regular intervals.
- During Standby mode, the [Setup] button is disabled, and you cannot switch to the web setup screen [Setup].

Web screen configurations (continued)

Web setup screen [Setup]

The settings for the unit are selected on this screen.

Note

- The setting menu operations can be performed only by users whose access level is "1. Administrator". For the procedure used to set the access level, refer to page 101.

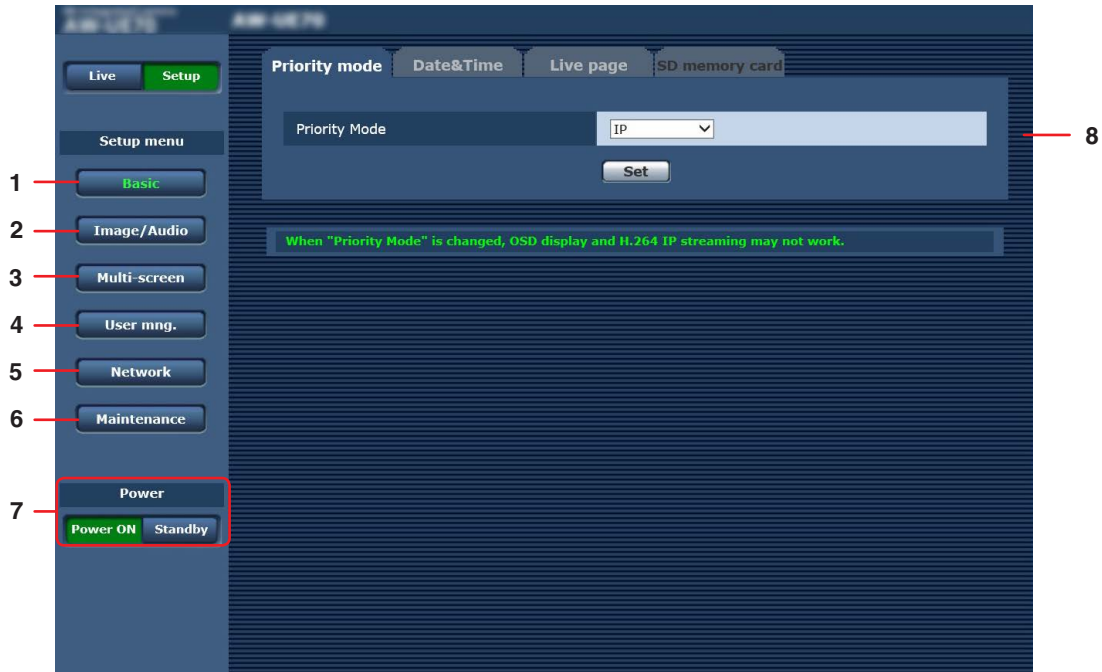

1. Basic button [Basic]

When the Basic button is pressed, the Basic screen is displayed in the main area.
→ "Basic screen [Basic]" (page 77)

2. Image/Audio button [Image/Audio]

When the Image/Audio button is pressed, the Image/Audio screen is displayed in the main area.
→ "Image screen [Image/Audio]" (page 80)

3. Multi-screen button [Multi-screen]

When the Multi-screen button is pressed, the Multi-screen setup screen is displayed in the main area.
→ "Multi screen setup screen [Multi-screen]" (page 100)

4. User mng. button [User mng.]

When the User mng. button is pressed, the User mng. screen is displayed in the main area.
→ "User management screen [User mng.]" (page 101)



5. Network button [Network]

When the Network button is pressed, the Network setup screen is displayed in the main area.
→ "Network setup screen [Network]" (page 103)

6. Maintenance button [Maintenance]

When the Maintenance button is pressed, the Maintenance screen is displayed in the main area.
→ "Maintenance screen [Maintenance]" (page 119)

7. Power ON button [Power ON] / Standby button [Standby]

 [Power ON]	Turn the unit on.
 [Standby]	Set the unit to Standby mode.

When you enter Standby mode, the display will automatically switch to Live mode. In addition, the [Setup] button in the live screen [Live] will be disabled, and you cannot operate the web setup screen [Setup].

8. Main area

The menu screen is displayed.

Web screen configurations (continued)

Basic screen [Basic]

Priority mode tab [Priority mode]

Set the priority output of video.

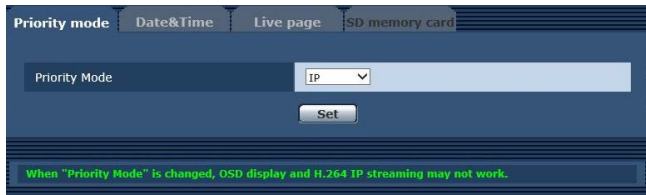

Priority Mode

Configure the setting for the priority output of video.

Setting value:

IP	Enables IP image transmission over multiple channels. The IP transmission of H.264 images is also supported.
SD card	Inserting an SD card (optional accessory) into the unit enables recording H.264 images to the SD card. The data recorded to the SD card can be played back on the Web screen, downloaded to a personal computer, and transferred to an FTP server. “Recording to and playing back from a memory card” (page 124)
USB	Enables the unit to be used as a Web camera. The camera can also be controlled from a personal computer. “Web camera functions” (page 128)
NDI HX	Transmits video to NewTek NDI compatible software applications and hardware devices over a network. The function supports H.264/IP transmission using NDI HX.

Factory settings: IP

Notes

- When the priority mode is changed, the operation of the mode before the change is forcefully stopped.
- The “IP” and “SD card” mode require various settings to be configured from a personal computer connected via the network.

Clock settings tab [Date&Time]

Configure the settings for the clock.

Set the clock using any of the three methods: “PC synchronization”, “NTP”, and “Manual”.



● setup

Display

Set the display of the date and time on the Live screen.

Factory settings: Off

PC synchronization

If you click the [Execute] button, the settings are configured by synchronizing the unit to the date and time of the connected personal computer.

Note

- The time zone of the personal computer is not reflected on the unit.
Set the time zone on the unit.

NTP

If you click “NTP>>”, the settings screen for the NTP server appears. (page 108)

Manual - Date/time

Configure the settings for the month, day, and year and for the hour, minute, and second.

Notes

- The data display format is Mmm/DD/YYYY.
- The time is in the 24-hour format.

Manual - Time zone

Selects the time zone according to the region where the camera is being used.

Factory settings:

(GMT) Greenwich Mean Time : Dublin, Edinburgh, Lisbon, London

Web screen configurations (continued)

Manual - Summer time (daylight saving)

Sets whether to use summer time.
 Selects the time zone that corresponds with the region in which the unit is going to be used.

Setting value:

In	Sets the time to summer time.
Out	Cancels summer time.
Auto	Switches to summer time according to the start/end time and date settings (time, day, week, month).

Factory settings: Out

Note

- “**” is added to the date and time indication on the Live screen during summer time.
 If summer time is not displayed correctly, refresh the screen.

Manual - Start time & date

Manual - End time & date

Sets the summer time start/end time and date by time, day, week and month when [Auto] is selected in the [Manual - Summer time (daylight saving)] setting.

Notes

- The “Start time & date” and “End time & date” settings cannot be set to the same value.
 If the same value is set, all the items under “Manual -” are restored to their original values.
- If a more accurate time setting is required for system operation, use an NTP server. (page 108)

Live page tab [Live page]

Configure the setting for the camera title.



Camera title

Input the name of the camera here.
 When the [Set] button is clicked, the input name appears in the camera title display area.

- The factory default setting is the model number of the unit.
- You can enter between 0 to 20 half-size characters.
- The following characters can be displayed.

Half-size numeric characters	0123456789
Half-size alphabetical characters (upper and lower cases)	ABCDEFGHIJKLMNOPQRSTUVWXYZ abcdefghijklmnopqrstuvwxyz
Symbols	!#\$%^()*+,-./:;=?@[]_`{ }~\

Automatic installation of viewer software

Configure settings for the automatic installation of the plug-in viewer software.

Factory settings: On

Smoother live video display on the browser (buffering)

Configure settings for displaying images from the unit on the plug-in viewer software.

Setting value:

On	Temporarily store images from the unit onto the personal computer for smoother display. However, the screen display images will be displayed later than the actual images.
Off	Do not temporarily store images from the unit onto the personal computer, and display them in real time. However, the motion of the screen display images may not be smooth.

Factory settings: On

Web screen configurations (continued)

■ SD card tab [SD memory card]

Configure the format settings for the video to be recorded to an SD card or initialize a card.

- The priority mode needs to be set to “SD card”. For details, refer to “Priority mode tab [Priority mode]” (page 77).



● Recording setting

Recording format

Set the size, frame rate, and bit rate of the video to be recorded to an SD card.

Setting value:

[When 59.94 Hz has been set as the unit's frequency]

Recording format	Priority Mode
1920x1080/59.94p 28Mbps	SD card
1920x1080/29.97p 15Mbps	
1920x1080/29.97p 10Mbps	
1920x1080/29.97p 6Mbps	
1280x720/59.94p 15Mbps	
1280x720/29.97p 8Mbps	
1280x720/29.97p 4Mbps	
1280x720/29.97p 2Mbps	
1280x720/29.97p 1Mbps	

[When 50 Hz has been set as the unit's frequency]

Recording format	Priority Mode
1920x1080/50p 28Mbps	SD card
1920x1080/25p 15Mbps	
1920x1080/25p 10Mbps	
1920x1080/25p 6Mbps	
1280x720/50p 15Mbps	
1280x720/25p 8Mbps	
1280x720/25p 4Mbps	
1280x720/25p 2Mbps	
1280x720/25p 1Mbps	

Record tally

Turn the function for the tally lamp to light when recording to an SD card On/Off.

Factory settings: Off

● SD memory card information

Remaining capacity

(Remaining capacity/Original capacity)

Displays the remaining capacity and total capacity of the SD card.

- Capacity is indicated in GB. If a card is not inserted or recognized, “--- GB” is displayed.
- The correct capacity may not be displayed immediately after an SD card is formatted (initialized) or if an SD card is inserted after opening the SD card tab. If that happens, click the [Reload] button.

Format

When you click the [Execute] button, a confirmation message appears.

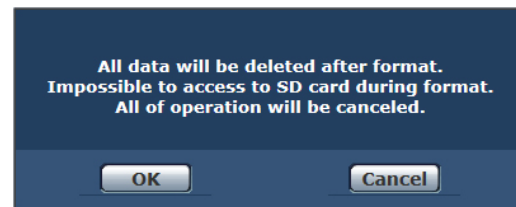

When you click the [OK] button, the SD card is formatted (initialized).

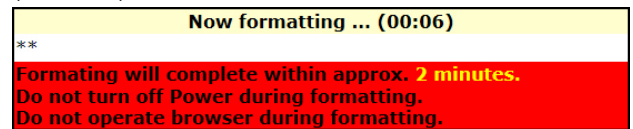

Notes

- Recording to an SD card is not possible during formatting.
- If you perform formatting, all of the data stored on the SD card will be deleted.
- Do not turn off the power of the unit during formatting.
- Formatting resets numbering of folders and files.

Web screen configurations (continued)

Image screen [Image/Audio]

IP video settings tab [Video over IP]

The JPEG image and H.264 image settings as well as the settings related to image quality are selected on this screen.

Video over IP | Audio | **Image/Position** | System

Initial display settings for "Live" page

Stream:

JPEG

JPEG(1)

JPEG transmission: On Off

Image capture size:

Refresh interval:

Image quality: Fine Normal

JPEG(2)

JPEG transmission: On Off

Image capture size:

Refresh interval:

Image quality: Fine Normal

JPEG(3)

JPEG transmission: On Off

Image capture size:

Refresh interval:

Image quality: Fine Normal

H.264(1)

H.264 transmission: On Off

Internet mode (over HTTP): On Off

Image capture size:

Transmission priority:

Frame rate:

Max bit rate (per client) *: Max - Min

Image quality: Motion priority Image quality priority

Transmission type:

Unicast port(Image): (1024-50000)

Unicast port(Audio): (1024-50000)

Multicast address:

Multicast port: (1024-50000)

Multicast TTL/HOPLimit: (1-254)

H.264(2)

H.264 transmission: On Off

Internet mode (over HTTP): On Off

Image capture size:

Transmission priority:

Frame rate:

Max bit rate (per client) *: Max - Min

Image quality: Motion priority Image quality priority

Transmission type:

Unicast port(Image): (1024-50000)

Unicast port(Audio): (1024-50000)

Multicast address:

Multicast port: (1024-50000)

Multicast TTL/HOPLimit: (1-254)

H.264(3)

H.264 transmission: On Off

Internet mode (over HTTP): On Off

Image capture size:

Transmission priority:

Frame rate:

Max bit rate (per client) *: Max - Min

Image quality: Motion priority Image quality priority

Transmission type:

Unicast port(Image): (1024-50000)

Unicast port(Audio): (1024-50000)

Multicast address:

Multicast port: (1024-50000)

Multicast TTL/HOPLimit: (1-254)

H.264(4)

H.264 transmission: On Off

Internet mode (over HTTP): On Off

Image capture size:

Transmission priority:

Frame rate:

Max bit rate (per client) *: Max - Min

Image quality: Motion priority Image quality priority

Transmission type:

Unicast port(Image): (1024-50000)

Unicast port(Audio): (1024-50000)

Multicast address:

Multicast port: (1024-50000)

Multicast TTL/HOPLimit: (1-254)

Initial display settings for "Live" page

Stream

Select the images to display when the Live screen [Live] is opened.

Setting value:

H.264(1)	Windows	Display videos (H.264(1)).
H.264(2)	Windows	Display videos (H.264(2)).
H.264(3)	Windows	Display videos (H.264(3)).
H.264(4)	Windows	Display videos (H.264(4)).
JPEG(1)		Display still images (JPEG(1)).
JPEG(2)		Display still images (JPEG(2)).
JPEG(3)		Display still images (JPEG(3)).

Factory settings: H.264(1)

Web screen configurations (continued)

There are restrictions on the simultaneous transmission of JPEG and H.264.
For details, refer to page 86.

● JPEG

JPEG(1) • JPEG(2) • JPEG(3)

Configure the settings for JPEG images.

Note

- When the Priority Mode (page 56, page 77) selection is “NDI|HX”, “JPEG(2)” and “JPEG(3)” cannot be selected.

JPEG transmission

Set whether to transmit JPEG images.

Factory settings: On

Image capture size

Select from the following resolutions for the images to be displayed when displaying JPEG images.

Setting value:

1920×1080, 1280×720, 640×360, 320×180

Factory settings:

JPEG(1): 640×360

JPEG(2): 1280×720

JPEG(3): 320×180

Refresh interval

Select the frame rate for JPEG images.

Setting value:

For 59.94Hz:

5fps, 15fps, 30fps

For 50Hz:

5fps, 12.5fps, 25fps

Factory settings:

JPEG(1): 30fps

JPEG(2): 5fps

JPEG(3): 30fps

Note

- The frame rate may be slower depending on the network environment, resolution, image quality, access volume, etc.

Image quality

Specify the JPEG image quality (2 types) for each resolution.

Setting value: Fine, Normal

Factory settings: Fine

● H.264(1) • H.264(2) • H.264(3) • H.264(4)

Windows

Configure the settings for H.264 images.

Note

- When the Priority Mode (page 56, page 77) selection is “NDI|HX”, “H.264(3)” and “H.264(4)” cannot be selected.

H.264 transmission

Whether to transmit the H.264 images is set here.

Factory settings: On

Internet mode (over HTTP)

This setting is selected when transmitting H.264 images over the Internet.

H.264 images can be transmitted using the same broadband router settings as when transmitting JPEG images.

Setting value:

On	The H.264 images and audio are transmitted using the HTTP port. For details on setting the HTTP port number, refer to page 105.
Off	The H.264 images and audio are transmitted using the UDP port.

Factory settings: Off

Notes

- When [On] is set, only [Unicast port (AUTO)] can be selected as the [Transmission type] setting.
- When [On] is set, it takes a few seconds before the H.264 images are displayed.
- When this is set to [On], H.264 images may not appear depending on the number of users accessing the unit at the same time and whether audio data exists.
- When this is set to [On], access will be limited to IPv4.
- When the Priority Mode (page 56, page 77) selection is “NDI|HX”, this item is fixed to “Off”.

Web screen configurations (continued)

Image capture size

Select the resolution for H.264 images.
 Selectable options will vary depending on the selected resolution setting.

Setting value:

H.264(1)	1920×1080 1280×720 640×360 (when HDR is “Low” or “High”)
H.264(2)	1280×720 640×360 320×180
H.264(3)	1280×720 640×360 320×180
H.264(4)	1280×720 640×360 320×180

Note

- When the Priority Mode (page 56, page 77) selection is “NDI|HX”, the following settings will be available.
 H.264(1): 1920×1080, 1280×720
 H.264(2): 640×360

Transmission priority

Set the transmission mode for H.264 images.

Setting value:

Constant bit rate	Transmits H.264 images at the bit rate specified in [Max bit rate (per client)]. <ul style="list-style-type: none"> The “Frame rate” value is automatically determined (as 5fps to 30fps or 5fps to 25fps) according to the selected bit rate. (page 83)
Frame rate	Transmit H.264 images at the frame rate specified in [Frame rate]. <ul style="list-style-type: none"> Set the frame rate and bit rate and transmit. (page 83)
Best effort	Transmit H.264 images at a variable bit rate between the maximum and minimum specified in [Max bit rate (per client)], according to the network bandwidth. <ul style="list-style-type: none"> Depending on how the bit rate is changed, the “Frame rate” value is automatically determined (as 5fps to 30fps or 5fps to 25fps). (page 83)

Factory settings: Frame rate

Note

- When the Priority Mode (page 56, page 77) selection is “NDI|HX”, this item is fixed to “Frame rate”.

Frame rate

Set the frame rate for H.264 images.

Setting value:

- For 59.94Hz:**
5fps, 15fps, 30fps, 60fps
- For 50Hz:**
5fps, 12.5fps, 25fps, 50fps

Factory settings:

- For 59.94Hz:** 30fps
- For 50Hz:** 25fps

Notes

- When 1920×1080/60fps or 1920×1080/50fps is used, the setting becomes only H.264(1).
- When setting 1920×1080/60fps or 1920×1080/50fps, set H.264(4) to “Off”, and set the maximum value of “Max bit rate (per client)” to 16384kbps to 24576kbps.
- When the image resolution is “640×360” or “320×180”, 60fps or 50fps cannot be selected for the frame rate.

Max bit rate (per client)*

Specify the H.264 bit rate per client.
 When [Transmission priority] is set to [Best effort], specify the maximum and minimum bit rate.

Setting value:

- 512kbps, 768kbps, 1024kbps, 1536kbps, 2048kbps, 3072kbps, 4096kbps, 6144kbps, 8192kbps, 10240kbps, 12288kbps, 14336kbps, 16384kbps, 20480kbps, 24576kbps

* The H.264 bit rate is limited by the [Bandwidth control (bitrate)] (page 105) setting under the [Network] tab of the network setup screen [Network]. The actual bit rate may be lower than the specified value.

Web screen configurations (continued)

● Relationship between image capture size, frame rate, and H.264 bit rate

The range of H.264 bit rates that can be specified varies depending on the resolution.

When the Priority Mode (page 56, page 77) selection is "IP", the following settings will be available.

[When 59.94 Hz has been set as the unit's frequency]

Image capture size	Frame rate	H.264 bit rate
1920×1080	60fps	16384kbps to 24576kbps
1920×1080	5fps, 15fps, 30fps	1024kbps to 14336kbps
1280×720	60fps	3072kbps to 14336kbps
1280×720	5fps, 15fps, 30fps	512kbps to 8192kbps
640×360	5fps, 15fps, 30fps	512kbps to 4096kbps
320×180	5fps, 15fps, 30fps	512kbps to 4096kbps

Factory settings:

H.264(1): 1920×1080/30fps/14336kbps

H.264(2): 1280×720/30fps/8192kbps

H.264(3): 640×360/30fps/4096kbps

H.264(4): 640×360/30fps/4096kbps

[When 50 Hz has been set as the unit's frequency]

Image capture size	Frame rate	H.264 bit rate
1920×1080	50fps	16384kbps to 24576kbps
1920×1080	5fps, 12.5fps, 25fps	1024kbps to 14336kbps
1280×720	50fps	3072kbps to 14336kbps
1280×720	5fps, 12.5fps, 25fps	512kbps to 8192kbps
640×360	5fps, 12.5fps, 25fps	512kbps to 4096kbps
320×180	5fps, 12.5fps, 25fps	512kbps to 4096kbps

Factory settings:

H.264(1): 1920×1080/25fps/14336kbps

H.264(2): 1280×720/25fps/8192kbps

H.264(3): 640×360/25fps/4096kbps

H.264(4): 640×360/25fps/4096kbps

When the Priority Mode (page 56, page 77) selection is "NDI|HX", the following settings will be available.

[When 59.94 Hz has been set as the unit's frequency]

Image capture size	Frame rate	H.264 bit rate
1920×1080	60fps	8192kbps to 24576kbps
1920×1080	5fps, 15fps, 30fps	1024kbps to 14336kbps
1280×720	60fps	3072kbps to 14336kbps
1280×720	5fps, 15fps, 30fps	512kbps to 8192kbps
640×360	5fps, 15fps, 30fps	512kbps to 1024kbps

Factory settings:

H.264(1): 1920×1080/30fps/10240kbps

H.264(2): 640×360/30fps/1024kbps

[When 50 Hz has been set as the unit's frequency]

Image capture size	Frame rate	H.264 bit rate
1920×1080	50fps	8192kbps to 24576kbps
1920×1080	5fps, 12.5fps, 25fps	1024kbps to 14336kbps
1280×720	50fps	3072kbps to 14336kbps
1280×720	5fps, 12.5fps, 25fps	512kbps to 8192kbps
640×360	5fps, 12.5fps, 25fps	512kbps to 1024kbps

Factory settings:

H.264(1): 1920×1080/25fps/10240kbps

H.264(2): 640×360/25fps/1024kbps

Image quality

Select the image quality for H.264 images.

Setting value:

Motion priority	Mode giving priority to image motion.
Image quality priority	Mode giving priority to image quality.

Factory settings: Motion priority

Note

- This setting is only enabled when [Transmission priority] is set to [Constant bit rate] or [Best effort].

Web screen configurations (continued)

Transmission type

Select the transmission format for H.264 images.

Setting value:

Unicast port (AUTO)	Up to 14 users can access a single camera at the same time. [Unicast port (Image)] and [Unicast port (Audio)] will be configured automatically when images and audio are sent from the camera. We recommend selecting the [Unicast port (MANUAL)] setting when the port number transmitting the H.264 images does not need to be fixed (e.g., during use within a network).
Unicast port (MANUAL)	Up to 14 users can access a single camera at the same time. [Unicast port (Image)] and [Unicast port (Audio)] must be configured manually when images and audio are sent from the camera. When transmitting H.264 images via the Internet, configure a fixed transmission port for the broadband router (hereafter referred to as "router") (page 103). For details, refer to the operating instructions for the router.
Multicast	An unlimited number of users can access a single camera at the same time. When transmitting H.264 images via multicast, enter the [Multicast address], [Multicast port], and [Multicast TTL/HOPLimit].

Factory settings: Unicast port (AUTO)

Note

- For details on the maximum number for simultaneous access, see page 68.

Unicast port(Image)

Enter the unicast port number (used when sending images from the unit).

Usable port number range: 1024 to 50000

- Only even numbers can be specified.
- The port number cannot be set to 10670.

Factory settings:

H.264(1): 32004
H.264(2): 32014
H.264(3): 32024
H.264(4): 32034

Unicast port(Audio)

Usable port number range: 1024 to 50000

- Only even numbers can be specified.
- The port number cannot be set to 10670.

Factory settings:

H.264(1): 33004
H.264(2): 33014
H.264(3): 33024
H.264(4): 33034

Note

- The unicast port number must be configured when [Transmission type] is set to [Unicast port (MANUAL)].

Multicast address

Enter the multicast IP address.

Images and audio will be sent to the specified IP address.

Usable values:

IPv4: 224.0.0.0 to 239.255.255.255
IPv6: Multicast address starting with FF.

Factory settings:

H.264(1): 239.192.0.20
H.264(2): 239.192.0.21
H.264(3): 239.192.0.22
H.264(4): 239.192.0.23

Note

- Verify usable multicast IP addresses before entering this setting.

Multicast port

Enter the multicast port number (used when sending images from the unit).

Usable port number range: 1024 to 50000

- Only even numbers can be specified.
- The port number cannot be set to 10670.

Factory settings: 37004

Note

- When sending audio from the unit, a port number with "1000" added to the multicast port number will be used.

Multicast TTL/HOPLimit

Enter the TTL/HOPLimit value for multicast.

Usable values: 1 to 254

Factory settings: 16

Notes

- When transmitting H.264 images via the Internet, transmitted images may not appear depending on proxy server settings, firewall settings, etc. In such cases, consult your network administrator.
- When displaying multicast images on a personal computer with multiple LAN cards installed, disable the LAN cards that are not used for reception.

Note

- IP control can be performed but if you do not want to perform IP image transmission, set "JPEG transmission", "H.264 transmission" and "Audio Transmission" to "Off".
In this case, IP images will also not be displayed on the mobile terminal.

Web screen configurations (continued)

List of settings for transmission output of IP video

• When “Priority Mode” is set to “IP”

Settings		H.264(1)	H.264(2)*1	H.264(3)*1	H.264(4)*2	JPEG(1)/JPEG(2)/JPEG(3)
Resolution		1920×1080 1280×720*1 640×360*3	1280×720 640×360 320×180	1280×720 640×360 320×180	1280×720 640×360 320×180	1920×1080*2 1280×720*1 640×360 320×180*1
Frame rate	System frequency 59.94 Hz	60fps				
		30fps	30fps	30fps	30fps	30fps
		15fps	15fps	15fps	15fps	15fps
	5fps	5fps	5fps	5fps	5fps	
System frequency 50 Hz	50fps					
	25fps	25fps	25fps	25fps	25fps	25fps
	12.5fps	12.5fps	12.5fps	12.5fps	12.5fps	12.5fps
	5fps	5fps	5fps	5fps	5fps	5fps

*1: Settable when HDR is “Off”.

*2: Settable when HDR is set to “Off” and the frame rate is other than 60fps (or 50fps).

*3: Not settable when HDR is “Off”.

• When “Priority Mode” is set to “SD card” or “USB”

Settings		H.264(1)/H.264(2)/H.264(3)/H.264(4)	JPEG(1)/JPEG(2)*5	JPEG(3)
Resolution		---	640×360 320×180*4	---
Frame rate	System frequency 59.94 Hz	---	30fps	---
		---	15fps	---
		---	5fps	---
	System frequency 50 Hz	---	25fps	---
---		12.5fps	---	
---		5fps	---	

*4: Settable when HDR is “Off”.

*5: JPEG(2) can only be configured when “Priority Mode” is set to “SD card”.

• When “Priority Mode” is set to “NDI|HX”

Settings		H.264(1)	H.264(2)	H.264(3)/H.264(4)	JPEG(1)	JPEG(2)/JPEG(3)	
Resolution		1920×1080 1280×720	640×360	---	640×360	---	
Frame rate	System frequency 59.94 Hz	60fps					
		30fps	30fps		30fps		
		15fps	15fps	---	15fps	---	
		5fps	5fps		5fps		
	System frequency 50 Hz	50fps					
		25fps	25fps		25fps		
		12.5fps	12.5fps	---	12.5fps	---	
		5fps	5fps		5fps		

Web screen configurations (continued)

Restrictions of IP streaming

Each bit rate value varies depending on the JPEG(1) to (3) and H.264(1) to (4) settings.

If the bit rate total exceeds the bit rate shown below, configuration and transmission may not be possible.

If configuration of JPEG(1) to (3) and H.264(1) to (4) settings is not possible, check the bit rate total and then configure the settings again.

Bit rate check	Maximum bit rate	“Internet mode (over HTTP)” setting (page 81)
Total of JPEG(1) to (3)	Approx. 66 Mbps	—
Total of JPEG(1) to (3) and H.264(1) to (4)	Approx. 66 Mbps	On

• JPEG

Image capture size	Refresh interval		Bit rate
	System frequency 59.94 Hz	System frequency 50 Hz	
1920×1080	30fps	25fps	Approx. 59 Mbps
	15fps	12.5fps	Approx. 30 Mbps
	5fps	5fps	Approx. 10 Mbps
1280×720	30fps	25fps	Approx. 44 Mbps
	15fps	12.5fps	Approx. 22 Mbps
	5fps	5fps	Approx. 8 Mbps
640×360	30fps	25fps	Approx. 15 Mbps
	15fps	12.5fps	Approx. 8 Mbps
	5fps	5fps	Approx. 3 Mbps
320×180	30fps	25fps	Approx. 7 Mbps
	15fps	12.5fps	Approx. 4 Mbps
	5fps	5fps	Approx. 2 Mbps

- The bit rate values are when “Fine” is selected for “Image quality” (page 81). When “Normal” is selected, the image bit rate becomes lower than when “Fine”.
- The bit rate values above are the maximum values.
For normal images, the values will become approximately 1/2 to 1/4.

Web screen configurations (continued)

■ Audio tab [Audio]

Configure audio settings.

Notes

- Images and audio are not synchronized. Therefore, images and audio may be slightly out of sync.
- The audio may skip depending on the network environment.

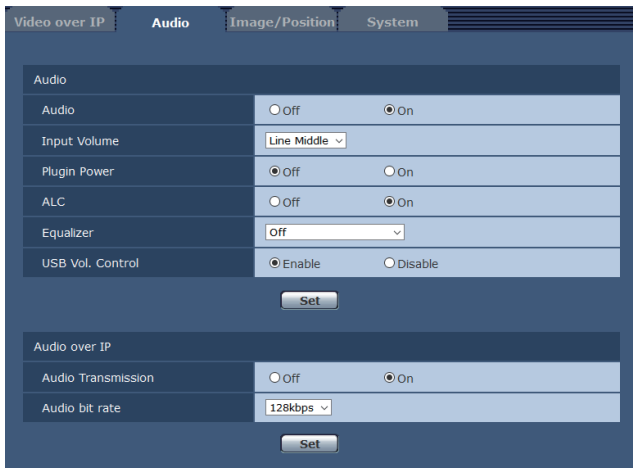

● Audio

Audio

Enable/disable the audio input signal from the device connected to the audio input connector.

Factory settings: Off

Input Volume

Set the volume of the audio from the unit when listening to it on the personal computer.

Setting value:

Mic High	Set the volume to high. Use this when audio is input to the camera via a microphone.
Mic Middle	Set the volume to medium. Use this when audio is input to the camera via a microphone.
Mic Low	Set the volume to low. Use this when audio is input to the camera via a microphone.
Line High	Set the volume to high. Use this when audio is input to the camera via line input.
Line Middle	Set the volume to medium. Use this when audio is input to the camera via line input.
Line Low	Set the volume to low. Use this when audio is input to the camera via line input.

Factory settings: Line Middle

Plugin Power

Turn plug-in power Off/On.

Factory settings: Off

ALC

Turn automatic level adjustment for the audio Off/On.

Factory settings: On

Equalizer

Set the equalizer function.

Setting value:

Off	Do not use the equalizer function.
Low Cut	Cut low frequencies to reduce the noise of an air-conditioning unit, projector, or other equipment.
Speech Enhancement	Cut low frequencies and high frequencies to enhance the clarity of speech.

Factory settings: Off

USB Vol. Control

Enable/disable control of the volume (page 130) with communication software when the unit is used as a Web camera.

Disable:

Disable control of the volume with communication software.

Enable:

Enable control of the volume with communication software.

Note

- When set to [Enable], the volume controls on the communication software change the volume on the unit. Audio may not be stable depending on the combination of the unit and communication software. Set to [Disable] if this is the case.

Factory settings: Enable

● Audio over IP

Audio Transmission

Set the communication mode used to transmit audio data to a personal computer, etc.

Setting value:

Off	Do not transmit audio data. All settings and controls related to audio will be disabled.
On	Transmit audio data. This allows audio as well as images to be viewed on the personal computer.

Factory settings: On

Audio bit rate

Set the bit rate for transmitting audio.

Setting value: 64kbps, 96kbps, 128kbps

Factory settings: 128kbps

Web screen configurations (continued)

■ Image adjust / preset position tab [Image/Position]

Display the image quality adjustment / preset position screen.

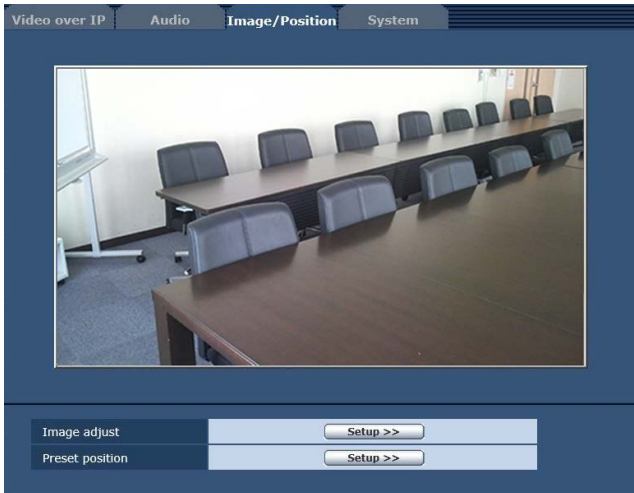

Image adjust

When you click the [Setup>>] button, the image adjust screen [Image adjust] appears.

Preset position

When you click the [Setup>>] button, the preset position screen [Preset position] appears. (page 94)

● Image adjust

Adjust the image quality.

To display the Image adjust screen, click the [Setup>>] button for [Image adjust] in the image adjust / preset position tab [Image/Position].

The settings in this screen (with the exception of [Scene]) are applied immediately.

Scene

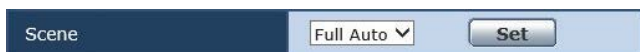

Selected here is the shooting mode that matches the shooting situation.

Select the mode which best suits the prevailing shooting conditions and the user's preferences.

Setting value:

Full Auto	In this mode, the optimum settings and adjustments for the shooting conditions at hand are automatically established. When "Full Auto" has been selected, the detailed setting and adjustment menus are not displayed.
Manual1 to 3	In these modes, the detailed settings and adjustments are established manually to match the prevailing shooting conditions and the user's preferences. When the Manual1, Manual2 or Manual3 mode has been selected, the detailed setting and adjustment menu for the mode concerned is displayed.

Factory settings: Full Auto

● Contrast

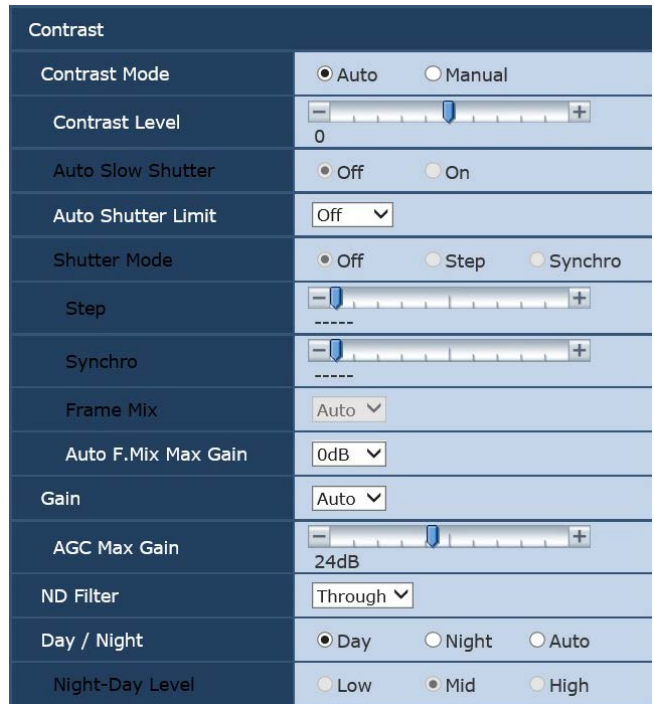

Contrast Mode

This item is used to select whether the image brightness (contrast) is to be controlled automatically or manually.

Setting value:

Auto	The iris, shutter speed and frame addition are controlled and the camera brightness is adjusted automatically.
Manual	Operations are performed using the manually set values.

Factory settings: Auto

Contrast Level

Set here is the contrast level when the image brightness is adjusted.

This item can be set when "Auto" has been selected as the "Contrast Mode" setting.

Setting range: -10 to +10

Factory settings: 0

Auto Slow Shutter

Determines whether or not Auto Slow Shutter is used.

- This can only be configured when "Scene" is set to "Full Auto".

Web screen configurations (continued)

Auto Shutter Limit

Sets the shutter speed limit that applies when using Auto Shutter.

- This setting is effective when “Scene” is set to “Manual1” to “Manual3” and “Contrast Mode” is set to “Auto”.

Setting value:

For 59.94Hz

Off, 1/60, 1/100, 1/120, 1/250

For 50Hz

Off, 1/50, 1/100, 1/125, 1/250

Factory settings: Off

Note

- Setting a shutter speed limit restricts the range of brightness that can be followed, so overexposure may occur with brightly lit subjects. In such cases, change the “ND Filter” setting to adjust light intensity as needed.

Shutter Mode

Select for camera shutter mode.

This item can be set when “Manual” has been selected as the “Contrast Mode” setting.

When a higher shutter speed is selected, fast-moving subjects do not become blurred easily but the images will be darker.

Setting value:

Off	The shutter is set to OFF (so that it cannot be tripped).
Step	The step shutter is set (the steps can be changed).
Synchro	The synchro shutter is set (the setting can be changed continuously).

Factory settings: Off

The shutter speeds that can be set are listed below.

[When 59.94 Hz has been set as the unit’s frequency]

When “Step” is selected as the “Shutter Mode”	When “Synchro” is selected as the “Shutter Mode”
1/100, 1/250, 1/500, 1/1000, 1/2000, 1/4000, 1/10000	59.94 Hz to max. 660.09 Hz (255 steps)

Factory settings: 1/100

[When 50 Hz has been set as the unit’s frequency]

When “Step” is selected as the “Shutter Mode”	When “Synchro” is selected as the “Shutter Mode”
1/120, 1/250, 1/500, 1/1000, 1/2000, 1/4000, 1/10000	50.00 Hz to max. 570.12 Hz (255 steps)

Factory settings: 1/120

Frame Mix

Select for frame addition (gain-up using sensor storage) amount.

This item can be set when “Off” is selected as the “Shutter Mode” setting.

When frame addition is performed, it will appear as if the images are missing some frames.

Setting value: Auto, Off, 6dB, 12dB, 18dB, 24dB

Factory settings: Auto

Auto F.Mix Max Gain

When “Auto” for the “Contrast Mode” or “Auto” for the “Frame Mix” is selected, the maximum frame addition amount can be set.

If frame addition is performed at the Auto setting, it will appear as if the images are missing some frames.

Setting value: 0dB, 6dB, 12dB, 18dB

Factory settings: 0dB

Gain

The image gain is adjusted here.

In locations which are too dark, adjust the gain upward; conversely, in locations which are too bright, adjust it downward.

When “Auto” is set, the light quantity is adjusted automatically.

The noise increases when the gain is increased.

Setting value: Auto, 0dB, 3dB, 6dB, 9dB, 12dB, 15dB, 18dB, 21dB, 24dB, 27dB, 30dB, 33dB, 36dB, 39dB, 42dB, 45dB, 48dB

Factory settings: Auto

Web screen configurations (continued)

AGC Max Gain

When "Auto" is selected as the "Gain" setting, the maximum gain-up amount can be set.

Setting value: 6dB, 12dB, 18dB, 24dB, 30dB, 36dB, 42dB, 48dB

Factory settings: 24dB

ND Filter

Adjust light intensity by switching between optical ND filters that are built into the unit.

Setting value:

Auto	Automatically switches ND filters depending on the lighting conditions of the subject and shooting location. <ul style="list-style-type: none"> This can only be configured when "Scene" is set to "Full Auto".
Through	ND filter is not used.
1/4	Reduces light intensity to 1/4.
1/16	Reduces light intensity to 1/16.
1/64	Reduces light intensity to 1/64.

Factory settings: Through

Notes

- When "Night" is selected for Day/Night, the setting is fixed to "Through".
- When "Auto" is selected for Day/Night, you can select either "Auto" or "Through".
- When "Auto" is selected, ND filters are switched automatically. When filters are switched, there will be a momentary marked change in image brightness.
- Depending on the surrounding environment and conditions of use, filter switching may not occur as expected even when "Auto" is selected.

Day/Night

This is used to select normal shooting or low light shooting (by exposing the subjects to infrared rays).

For details, refer to "Contrast 2/2 screen" (page 48).

Setting value: Day, Night, Auto

Factory settings: Day

Night-Day Level

Adjust the level used while switching from Night mode to Day mode when Day/Night is set to "Auto".

This can only be configured when "Day/Night" is set to "Auto".

Setting value: Low, Mid, High

Factory settings: Mid

Picture

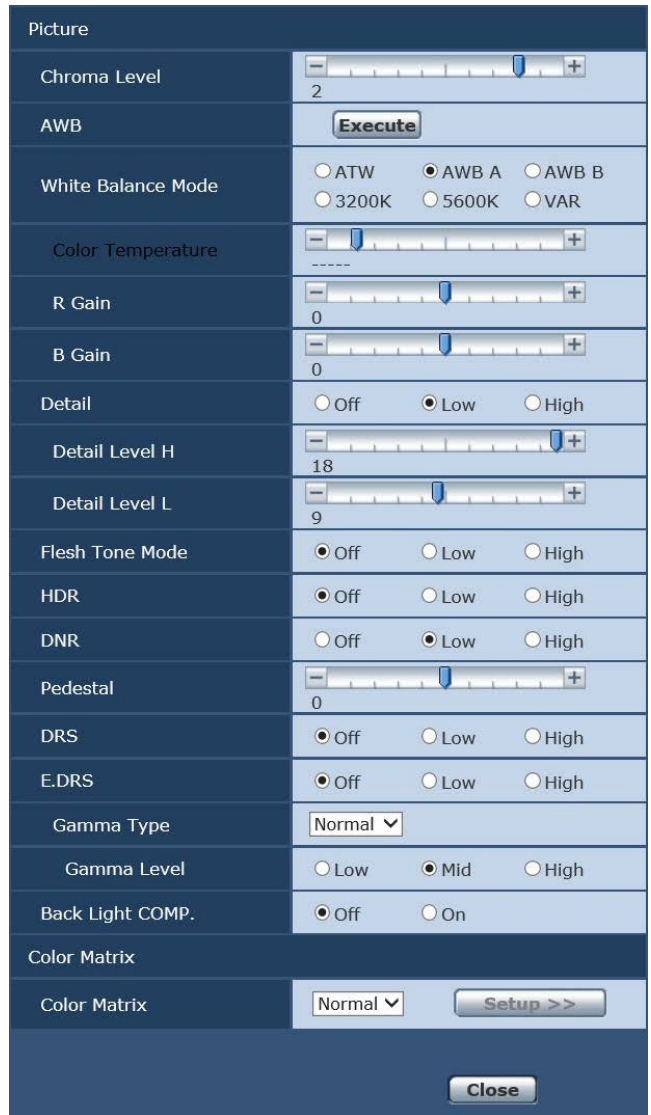

Chroma Level

Set here is the color intensity (chroma level) of the images.

Setting range: -3 to +3

Factory settings: +2

AWB

When you click the [Execute] button, this is used to execute automatic white balance (AWB) to set the white balance.

For details, refer to page 39.

Web screen configurations (continued)

White Balance Mode

The white balance mode is selected here.

Select the mode when the coloring is not natural because of the nature of the light source or other factors.

If the white color serving as the reference can be recognized, subjects can be shot with natural coloring.

Setting value:

ATW	This mode automatically corrects the white balance, even if the light source or color temperature changes.
AWB A, AWB B	When AWB A or AWB B is selected and the white balance is executed, the adjustment results obtained are stored in the memory selected. When AWB A or AWB B is then selected, the white balance stored in the selected memory can be recalled.
3200K	This white balance mode is ideal when a 3200K halogen light is used as the light source.
5600K	This white balance mode is ideal when 5600K sunlight or fluorescent lighting is used as the light source.
VAR	Specify a color temperature from 2400K to 9900K.

Factory settings:

Manual1: ATW
Manual2: AWB A
Manual3: AWB B

Color Temperature

Specify a color temperature from 2400K to 9900K (in increments of about 100K).

This is enabled when White Balance Mode is set to "VAR".

Setting range: 2400K to 9900K

Factory settings: 3200K

R Gain, B Gain

When "AWB A", "AWB B" or "VAR" is selected as the White Balance Mode setting, the white balance can be finely adjusted after automatic white balance (AWB) has been performed.

Setting range: -30 to +30

Factory settings: 0

Notes

- When automatic white balance (AWB) is executed, the R Gain and B Gain values are returned to "0".
- When "AWB A", "AWB B" or "VAR" is selected as the White Balance Mode setting, the R Gain and B Gain adjustment values can be stored in the three memories, A, B and VAR.
- When new values are set, the previous values are erased.
Use each of the memories for a different purpose in accordance with the shooting conditions.
- R Gain and B Gain adjustments cannot be performed when "White Balance Mode" is set to "ATW", "3200K", or "5600K".

Detail

The image detail (image sharpness) is adjusted here.

When "Low" or "High" is selected, the detail is enhanced.

Setting value: Off, Low, High

Factory settings: Low

Detail Level H

The image sharpness level is adjusted here when "High" has been selected as the "Detail" setting.

Setting range: Detail Level L setting +1 to 18

Factory settings: 18

Detail Level L

The image sharpness level is adjusted here when "Low" has been selected as the "Detail" setting.

Setting range: 1 to Detail Level H setting -1

Factory settings: 9

Flesh Tone Mode

Set here is the flesh tone mode for displaying the subjects' skin so that it appears more smoothly and eye-pleasingly.

When "Low" or "High" is selected, the effect is enhanced.

Setting value: Off, Low, High

Factory settings: Off

HDR

Adjust the effect of the high dynamic range mode.

When HDR is set to "Low", correction is performed so that the appropriate exposure is obtained for the light and dark areas on subjects with extremely high contrast. When "High" is selected, dark areas are made brighter. Depending on the shooting conditions, however, the picture quality may drop with increased noise.

In addition, unit vibration may result in blurry or distorted images.

This effect is not recommended in shooting locations where significant vibration may occur.

Setting value: Off, Low, High

Factory settings: Off

Notes

- When the HDR setting is changed, the monitor images will go momentarily black and the audio will be muted. Furthermore, IP video may stop for about 30 seconds.
- When "Low" or "High" is selected, it will take longer for the brightness of the image to converge.
- When "Low" or "High" is selected, brightness cannot be adjusted.
- When "Low" or "High" is selected, video will be delayed by 4 frames.

Notes

- When “Low” or “High” is selected, the following settings cannot be changed.
 - Auto Shutter Limit
 - ND Filter
 - Day/Night
 - Night-Day Level
 - Pedestal
 - DRS
 - Gamma Type
 - Back Light COMP.
 - Freeze During Preset
- When “Low” or “High” is selected, the OSD menu cannot be displayed for the video on the Web screen. However, the OSD menu can be displayed over video output to a monitor.
- If you attempt to display the OSD menu on the Web screen when “Low” or “High” is set, the HDR item becomes bar display and the setting cannot be changed. Change the setting from the Web setting screen, infrared remote control, etc.
- When the Priority Mode (page 56, page 77) is “IP” mode and when HDR is set to “Low” or “High”, there are the following restrictions.
 - JPEG(1) to (3): Fixed to 640×360.
 - H.264(1): 1280×720 cannot be used.
 - H.264(2) to (4): Cannot be used.
- When the Priority Mode (page 56, page 77) selection is “NDI|HX”, this item is fixed to “Off”.
- When the OIS (page 59, page 98) selection is “Mode2”, changing the HDR setting to “Low” or “High” automatically switches the OIS setting to “Mode1”.

DNR

Set here is the level of the digital noise reduction effect so that light, noise-free and clear images will be output even at night and in other low-brightness environments. When “Low” or “High” is selected, noise can be eliminated. However, there is an increased possibility that afterimages may occur.

Setting value: Off, Low, High

Factory settings: Low

Pedestal

This item is used to adjust the black level (adjust the pedestal) so that the dark parts of the images are easier to see.

These parts become darker when a negative setting is selected and, conversely, lighter when a positive setting is selected.

Setting range: -10 to +10

Factory settings: 0

DRS

Set here is the DRS function which provides just the right amount of compensation when images with significant light/dark differences are displayed.

When “Low” or “High” is selected, the effect is enhanced even more.

Depending on the shooting conditions, however, the picture quality may drop with increased noise.

Setting value: Off, Low, High

Factory settings: Off

E.DRS

Sets the E.DRS function, which provides a greater amount of compensation than DRS does when images with significant light/dark differences are displayed. Select “Low” or “High” to enhance the compensation effect.

Depending on the shooting conditions, however, the picture quality may drop with increased noise.

Setting value: Off, Low, High

Factory settings: Off

Notes

- When “Low” or “High” is selected, the brightness is automatically adjusted. To adjust the brightness convergence level, change the Contrast Level setting.
- When “Low” or “High” is selected, the following settings cannot be changed.
 - Day/Night
 - Night-Day Level
 - DRS
 - HDR
 - Gamma Type
 - Back Light COMP.
- Only one item, HDR, DRS or E.DRS, can be enabled. To enable E.DRS, set HDR and DRS to “Off”.
- When the Priority Mode (page 56, page 77) selection is “NDI|HX”, this item is fixed to “Off”.

Gamma Type

Selected here is the type of gamma curve.

Normally, the “Normal” setting is used.

When “Cinema” is selected, images giving off an atmosphere like movies can be shot.

Setting value: Off, Normal, Cinema

Factory settings: Normal

Gamma Level

This item is used to adjust the gamma compensation level. This is enabled when Gamma Type is set to “Normal”.

When “Low” is set, the images appear sedate and composed. The resulting gamma curve has a gentle gradient in the low-brightness areas, and the contrast is sharper.

Conversely, when “High” is set, the tonal range in the dark area is expanded so that the images take on a lighter tone. The resulting gamma curve has a sharp gradient in the low-brightness areas, and the contrast is softer.

Setting value: Low, Mid, High

Factory settings: Mid

Web screen configurations (continued)

Back Light COMP.

“Off” or “On” is set here for the backlight compensation function.

Under backlight conditions, the function prevents darkening as a result of light striking the backs of subjects, and makes it possible to shoot images in shade or shadow more brightly.

Factory settings: Off

Notes

- The function takes effect when “Auto” has been selected as the Contrast Mode, Gain or Frame Mix item setting.
- When Day/Night is set to “Auto”, this is set to “Off”.
- When HDR is set to “Low” or “High”, this is set to “Off”.

● Color Matrix

Color Matrix

The preset color matrix data is loaded, and the saturation and phase are compensated accordingly.

When “User” is selected, the saturation and phase can be finely adjusted using the 16-axis color matrix (B to Cy_B_B).

Setting value: Normal, EBU, NTSC, User

Factory settings: Normal

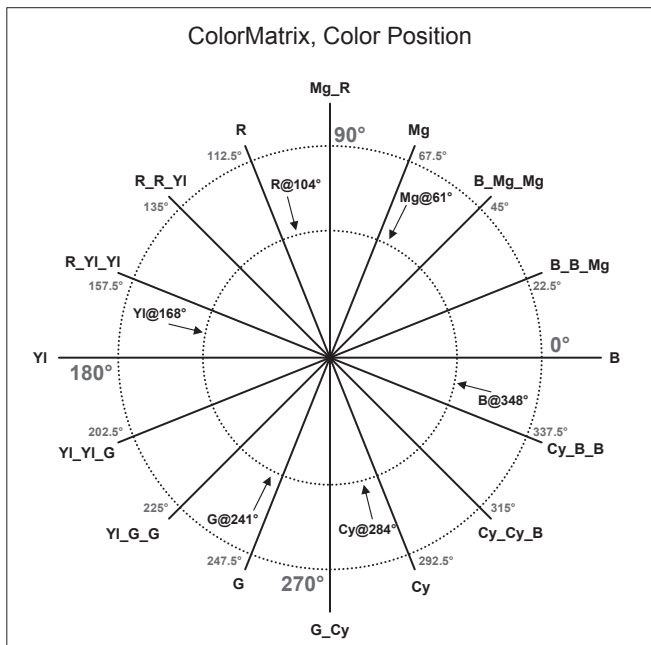

● User Color Matrix Setup screen (color matrix settings screen)

The User Color Matrix Setup screen is displayed when “User” is selected as the “Color Matrix” setting on the Image adjust screen and the [Setup>>] button is clicked.



B to Cy_B_B: Saturation

The saturation of B to Cy_B_B can be finely adjusted.

Setting range: -31 to +31

Factory settings: 0

B to Cy_B_B: Phase

The phase of B to Cy_B_B can be finely adjusted.

Setting range: -63 to +63

Factory settings: 0

Web screen configurations (continued)

● Preset position screen [Preset position]

Perform operations and adjustments related to preset positions.

To display the Preset position screen, click the [Setup>>] button for [Preset position] in the image adjust / preset position tab [Image/Position].

The settings in this screen (with the exception of [Preset]) are applied immediately.

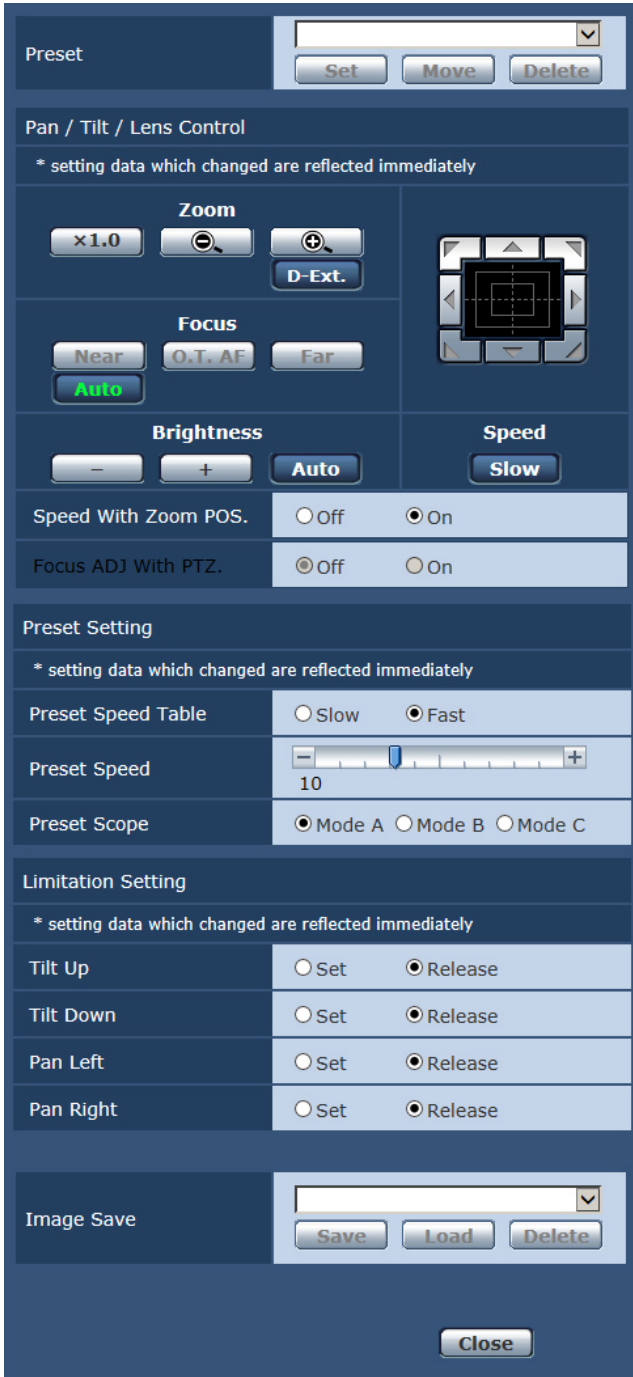

Preset

Preset	Home
Set	This is used to register the current status in the preset position now selected on the pull-down menu. It does not function if "Home" has been selected on the pull-down menu.
Move	The camera direction moves to the preset position which is now selected on the pull-down menu. The settings that are reproduced at this position are the settings which were established on the "Preset Scope" menu (page 58, page 95, page 97). The camera direction moves to the home position if "Home" has been selected on the pull-down menu.
Delete	This is used to delete the preset position setting which is currently being selected. It does not function if "Home" has been selected on the pull-down menu.

● Pan / Tilt / Lens Control

Zoom

D-Ext.	Use this to enable or disable the digital extender.
x1.0	Use this to adjust the zoom (magnification) to 1.0x.
Wide	Use this to adjust the zoom (magnification) in the Wide direction.
Tele	Use this to adjust the zoom (magnification) in the Tele direction.

Focus

Near	Use this to adjust the focus in the Near direction. It does not work during automatic adjustments.
O.T. AF	When this is pressed while the focus is being adjusted manually, the focus will be temporarily adjusted automatically. It does not work during automatic adjustments.
Far	Use this to adjust the focus in the Far direction. It does not work during automatic adjustments.
Auto	Use this to switch between auto and manual focusing.

Brightness

-	Use this to make the image darker. It does not work during automatic adjustments.
+	Use this to make the image lighter. It does not work during automatic adjustments.
Auto	Use this to switch the picture brightness adjustment between auto and manual.

Web screen configurations (continued)

Control pad and its buttons

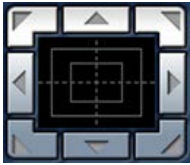

To adjust the image in the horizontal or vertical direction (panning or tilting), left-click the pad and the buttons. The more the outside of the pad is clicked, the faster the camera operates. Adjustment is also possible by dragging the mouse.

Right-click the pad to initiate zooming and focusing.

When the top half of the pad is clicked in the up or down direction, the zoom (magnification) is adjusted in the Tele direction; conversely, when the bottom half of the pad is clicked, the zoom is adjusted in the Wide direction.

When the left half of the pad is clicked in the left or right direction, the focus is adjusted in the Near direction; conversely when the right half of the pad is clicked, the focus is adjusted in the Far direction.

The zooming can also be adjusted by operating the mouse wheel.

Note

- When the mouse is used for dragging and dropping from the control pad area to a position outside this area, the panning, tilting and other operations will not stop. In a case like this, click the control pad area to stop these operations.

Speed



Use this to select the speed at which the pan, tilt, zoom and focus operations are to be performed.

Speed With Zoom POS.

“Off” or “On” is set here for the function used to adjust the pan-tilt adjustment speed in conjunction with the zoom magnification.

Setting value:

Off	The panning and tilting operations will not become slower in the zoom status.
On	The panning and tilting operations will become slower in the zoom status.

Factory settings: On

This function has no effect during preset operations.

Focus ADJ With PTZ.

“Off” or “On” is set here for the function which compensates for out-of-focusing when it occurs during panning, tilting or zooming operations.

Factory settings: Off

When “Off” is set, adjust the focus as required after zooming or set the focus to the auto mode.

This item can be selected only when “Manual” has been selected as the “Focus Mode” setting.

● Preset Setting

Preset Speed Table

Set the preset speed table (Slow, Fast).

During preset playback, preset actions are performed at Preset Speed (1 to 30) values that are based on the table set here.

Setting value:

Slow	Set the preset speed table to “Slow”.
Fast	Set the preset speed table to “Fast”.

Factory settings: Fast

Preset Speed

There are 30 preset pan-tilt operation speeds when regenerating the camera direction and other information which are registered in the preset memory.

Setting range: 1 to 30

Factory settings: 10

Note

- If a high value is selected for the Preset Speed setting, the image on the screen may shake when operation stops.

Preset Scope

Selected here are the setting items to be recalled when the contents of the preset memory are regenerated.

Setting value:

Mode A	Pan, Tilt, Zoom (including digital zoom), Focus, Iris, Gain, white balance adjustment value
Mode B	Pan, Tilt, Zoom (including digital zoom), Focus, Iris
Mode C	Pan, Tilt, Zoom (including digital zoom), Focus

Factory settings: Mode A

● Limitation Setting

This establishes the up, down, left and right limit settings of the pan-tilt head.

First, move the pan-tilt head to the desired limit position using the control pad and its buttons.

When the position is determined, select the desired “Set” setting from the list of settings below to set the position. (Select “Release” to release the setting.)

Tilt Up	Use this to save the current position as the upward limit.
Tilt Down	Use this to save the current position as the downward limit.
Pan Left	Use this to save the current position as the leftward limit.
Pan Right	Use this to save the current position as the rightward limit.

When “Set” or “Release” is selected, the tally lamp of the unit blinks.

When a limiter is set, it blinks once; when a limiter is released, it blinks twice.

Web screen configurations (continued)

● Image Save

You can record, play back, and delete JPEG format still images using microSD cards that conform to the SD standards.

The resolution recorded will be the same resolution as the JPEG stream with the lowest number. (The initial setting is JPEG(1))

Image Save	<input type="text" value="S1000001.JPG"/> <input type="button" value="Save"/> <input type="button" value="Load"/> <input type="button" value="Delete"/>
<p>Select the file name you want to operate from the pull-down menu. You can select S1000001.JPG to S1000099.JPG.</p>	
<input type="button" value="Save"/>	The image is saved using the file name selected in the pull-down menu.
<input type="button" value="Load"/>	Playback starts from the file name selected in the pull-down menu.
<input type="button" value="Delete"/>	The file name selected in the pull-down menu is deleted.

Notes

- The still image is recorded to the PRIVATE¥100CDPFQ folder on the microSD card.
- If the specified number is already used for a recorded still image, the image is replaced.
- A maximum of 99 images can be recorded.
- The buttons are disabled if a memory card has not been inserted, or if a still image with the specified number does not exist.

■ System settings tab [System]

This is the menu in which the camera's output image settings are configured.

The screenshot shows the 'System' settings tab. At the top, there are tabs for 'Video over IP', 'Audio', 'Image/Position', and 'System'. The 'System' tab is active. Below the tabs, there are several sections of settings:

- Genlock**: * setting data which changed are reflected immediately. Includes a 'Horizontal Phase' slider set to 0.
- Output**: Includes 'Frequency' (59.94Hz(NTSC) selected, 50Hz(PAL) unselected) and 'Set' button.
- Format (HDMI)**: Auto selected, 'Set' button.
- Format (SDI)**: 1080/59.94i selected, 'Set' button.
- Others**: A large section with many options:
 - Install Position: Desktop (selected), Hanging
 - Preset Speed Table: Slow, Fast (selected)
 - Preset Speed: Slider set to 10
 - Preset Scope: Mode A (selected), Mode B, Mode C
 - Freeze During Preset: Off (selected), On
 - Zoom Mode: Opt.Zoom, I.Zoom (selected), D.Zoom
 - Max Digital Zoom: Slider
 - D.Extender: Off (selected), On
 - D.Extender Magnification: x1.4
 - OIS: Off
 - Speed With Zoom POS: Off, On (selected)
 - Focus Mode: Auto (selected), Manual
 - Focus ADJ With PTZ: Off (selected), On
 - Tally: Disable, Enable (selected)
 - IR Control: Disable, Enable (selected)
 - IR ID: CAM1 (selected), CAM2, CAM3, CAM4
 - CAM/BAR: Camera (selected), Colorbar
 - Bars Type: Type1, Type2 (selected)
 - Bars Title: Off (selected), On
- OSD Mix**:
 - OSD Off With Tally: Off (selected), On
 - OSD Status: Off (selected), On
- Protocol**: Model Select dropdown set to SEVIHD1, 'Set' button.

● Genlock

This item's setting is reflected immediately.

Horizontal Phase

This is used to adjust the horizontal phase during genlock.

Setting range: -206 to +49

Factory settings: 0

Web screen configurations (continued)

● Output

This item's setting is reflected when the [Set] button is pressed.

Frequency

This item is selected to switch the frame frequency.

Setting value: 59.94Hz(NTSC), 50Hz(PAL)

- When the frequency is switched, "Format" is set as follows.

59.94Hz		50Hz
1080/59.94p	↔	1080/50p
1080/59.94i	↔	1080/50i
1080/29.97PsF	↔	1080/25PsF
1080/29.97p	↔	1080/25p
720/59.94p	↔	720/50p

Note

- If you change the frequency, the unit will restart automatically. Operation will not be possible while the unit is restarting. Some peripheral devices may not recognize that the unit has restarted. If you change the frequency, be sure to restart all peripheral devices.

Format (HDMI)

Format (SDI)

The video format is changed on this screen.

- For details on how to change the format, refer to "Changing the format" (page 57).
- For limitations that pertain when simultaneously outputting HDMI and SDI signals, refer to page 55.

Format	Setting value	
	Frequency: 59.94Hz(NTSC)	Frequency: 50Hz(PAL)
HDMI	Auto	Auto
	1080/59.94p	1080/50p
	1080/59.94i	1080/50i
	1080/29.97PsF	1080/25PsF
	1080/29.97p	1080/25p
SDI	720/59.94p	720/50p
	1080/59.94p	1080/50p
	1080/59.94i	1080/50i
	1080/29.97PsF	1080/25PsF
	1080/29.97p	1080/25p
	720/59.94p	720/50p

● Others

This item's setting is reflected when the [Set] button is pressed.

Install Position

"Desktop" or "Hanging" is selected here as the method used to install the unit.

Setting value:

Desktop	Stand-alone installation
Hanging	Suspended installation

Factory settings: Desktop

- When "Hanging" has been selected, the top, bottom, left and right of the images will be reversed, and up/down/left/right control for panning and tilting will also be reversed.

Preset Speed Table

Set the preset speed table (Slow, Fast).

During preset playback, preset actions are performed at Preset Speed (1 to 30) values that are based on the table set here.

Setting value:

Slow	Set the preset speed table to "Slow".
Fast	Set the preset speed table to "Fast".

Factory settings: Fast

Preset Speed

There are 30 preset pan-tilt operation speeds when regenerating the camera direction and other information which are registered in the preset memory.

Setting range: 1 to 30

Factory settings: 10

Note

- If a high value is selected for the Preset Speed setting, the image on the screen may shake when operation stops.

Preset Scope

Selected here are the setting items to be recalled when the contents of the preset memory are regenerated.

Setting value:

Mode A	Pan, Tilt, Zoom (including digital zoom), Focus, Iris, Gain, White-BAL
Mode B	Pan, Tilt, Zoom (including digital zoom), Focus, Iris
Mode C	Pan, Tilt, Zoom (including digital zoom), Focus

Factory settings: Mode A

Web screen configurations (continued)

Freeze During Preset

Turn the function for freezing images during preset playback Off/On.

When this is set to "On", preset playback is performed with a still of the image immediately preceding the start of preset playback being output. The image freeze is released when preset playback is finished.

Factory settings: Off

Notes

- When this is set to "On", the start of preset operations may be delayed momentarily due to the image being frozen.
- When HDR is set to "Low" or "High", this is set to "Off".

Zoom Mode

Configure the maximum zoom magnification.

Setting value:

Opt.Zoom	Use only the optical zoom. Up to 20x optical zoom is possible.
i.Zoom	Enable the i.Zoom function. Enabling this function allows you to perform electronic zoom while reducing drops in picture quality. Combining optical zoom and electronic zoom, up to 30x zoom is possible.
D.Zoom	Enable the digital zoom function. Picture quality degrades as zoom increases with digital zoom.

Factory settings: i.Zoom

Max Digital Zoom

Set the maximum digital zoom magnification.

This is only enabled when Zoom Mode is set to "D.Zoom".

Setting range: x2 to x12

Factory settings: x12

D.Extender

Set the digital extender function Off/On.

Factory settings: Off

When this function is enabled, the video magnification set with the "D. Extender Magnification" (digital zoom) is further increased. You can use this function to temporarily enlarge the image for confirmation of focus and such.

D.Extender Magnification

Set the magnification for the digital extender function.

Setting value: x1.4, x2.0, x4.0, x6.0, x8.0

Factory settings: x1.4

OIS

Set the optical image stabilization function.

Setting value:

Off	Image stabilization function not used.
Mode1	Image stabilization function used (optical, 2-axis compensation)
Mode2	Image stabilization function used (optical+electronic, 4-axis compensation)

Factory settings: Off

Notes

- "Mode2" cannot be selected when HDR is "Low" or "High".
- When "Mode2" is selected, the view angle changes to set aside image pixels for use during compensation.
- When "Mode2" is selected, display of the output image is delayed compared to the actual image.
- Although the image stabilization of "Mode2" (hybrid of optical and electronic compensation) produces stronger compensation than "Mode1", depending on the shooting conditions, it may not be able to differentiate between movement of the subject and movement of the unit as it performs compensation (electronic) on movement detected in the video signal. Therefore, erroneous compensation may occur.
- The image stabilization setting cannot be changed while data is being written to the SD card.

Speed With Zoom POS.

"Off" or "On" is set here for the function used to adjust the camera direction's adjustment speed in conjunction with the zoom magnification.

When "On" is set, the panning and tilting operations will become slower in the zoom status.

This function has no effect during preset operations.

Factory settings: On

Focus Mode

"Auto" or "Manual" is set here for the focusing function.

Setting value:

Auto	The subjects are always brought into focus automatically.
Manual	The focus is operated manually.

Factory settings: Auto

Focus ADJ With PTZ.

"Off" or "On" is set here for the function which compensates for out-of-focusing when it occurs during panning, tilting or zooming operations at the manual focus setting.

This item can be selected only when "Manual" has been selected as the "Focus Mode" setting.

Factory settings: Off

Web screen configurations (continued)

Tally

“Enable” or “Disable” is set here for the function which turns on or turns off the tally lamp using the tally control signal.

Setting value: Disable, Enable

Factory settings: Enable

IR Control

“Enable” or “Disable” is set here for operations conducted from the wireless remote control.

The operations are enabled when the unit's power is turned on from an external device other than a wireless remote control, and they are disabled when the power is turned on from a wireless remote control.

Setting value: Disable, Enable

Factory settings: Enable

Notes

- At the point when this item's setting is changed, the new setting is not reflected in operation. It is reflected when the unit is set to standby mode and its power is turned on.
- Follow one of the procedures below if the item's setting is changed by mistake and the unit can no longer be operated from a wireless remote control.

When menu operations can be performed using another control device:

→ First change the item using a control device capable of performing menu operations, and then turn off the unit's power and turn it back on.

When menu operations cannot be performed using other control devices:

1. Turn off the power of the units and devices that are connected.
2. Disconnect the unit's AC adaptor cable and LAN cable, and plug them back in.
3. Perform the operation for turning on the unit's power from the wireless remote control.
4. After changing this item, turn off the unit's power and turn it back on.

IR ID

Configure the unit's remote control ID.

The settings for this item correspond to the [CAM1] to [CAM4] buttons on the wireless remote control.

Setting value: CAM1, CAM2, CAM3, CAM4

Factory settings: CAM1

CAM/BAR

Switch between color bar display and camera image display on the monitor and the web setup screen.

Setting value: Camera, Colorbar

Factory settings: Camera

Note

- When the color bar is displayed, a test tone (1 kHz) is output according to the Audio setting in the camera menu.

Bars Type

Change the type of color bar to display. (page 60)

Setting value: Type1, Type2

Factory settings: Type2

Bars Title

Set camera title (page 78) display to Off/On for when the color bar is displayed.

Factory settings: Off

Note

- The camera title is not displayed when the camera's OSD menu is displayed in the Web screen.

● OSD Mix

This item's setting is reflected when the [Set] button is pressed.

OSD Off With Tally

This is used to enable or disable the function for clearing the OSD menu displays when the tally signal is received by a command or contact.

When the tally signal is released, the original OSD menu displays are restored.

Factory settings: Off

OSD Status

“Off” or “On” is set here for the status display which appears during AWB operations.

Factory settings: Off

● Protocol

This item's setting is reflected when the [Set] button is pressed.

Model Select

Set the protocol model for standard serial communication. Do not select “Reserved1” to “Reserved7”.

Setting value: SEVIHD1, SBRC300, SBRCZ330, Reserved1 to 7

Factory settings: SEVIHD1

Web screen configurations (continued)

Multi screen setup screen [Multi-screen]

The cameras whose images are to be displayed on the multi screen are set here.

Multi screen setup tab [Multi-screen setup]

This item's setting is reflected when the [Set] button is pressed.

IP address

Input here the IP address of the camera whose images are to be displayed on the multi screen or the host name. With one group consisting of 4 cameras, up to four groups of cameras (a total of 16 cameras) can be registered. Input as follows if the HTTP port number of the camera whose images are to be displayed has been changed.

IPv4 address entry example	http://192.168.0.10:8080
IPv6 address entry example	http://[2001:db8:0:0:0:0:1]:8080

Enter the following when connecting via HTTPS.

Example of input	https://192.168.0.10/
Maximum number of characters	1 to 128 half-size characters

Factory settings:

Cam. 1 to Cam. 16: blank

Notes

- When connecting via HTTPS, install the security certificate for the camera to be displayed. (page 117)
- When configuring a host name, the DNS settings of the personal computer that will display the multi screen must be configured. For details on the personal computer's DNS settings, consult your network administrator.

Camera title

Input the camera title here. The camera title which has been input is displayed on the multi screen.

- You can enter between 0 to 20 half-size characters.
- The following characters can be displayed.

Half-size numeric characters	0123456789
Half-size alphabetical characters (upper and lower cases)	ABCDEFGHIJKLMNOPQRSTUVWXYZ abcdefghijklmnopqrstuvwxyz
Symbols	!#\$%^()*+,-./:;=?@[^_`{ }~

Factory settings:

Cam. 1 to Cam. 16: blank

Notes

- When a 16-screen multi screen is selected, camera titles may be only partially displayed.
- Multi screen displays are displayed in 4:3 aspect ratio.

Web screen configurations (continued)

User management screen [User mng.]

The users and personal computers (IP addresses) that can access the unit from personal computers and mobile terminals are registered in the User mng. screen [User mng.].

User authentication settings tab [User auth.]

Click the [User auth.] tab of User mng. screen [User mng.]. Configure the user authorization settings for the personal computers and mobile terminals that can access the unit.

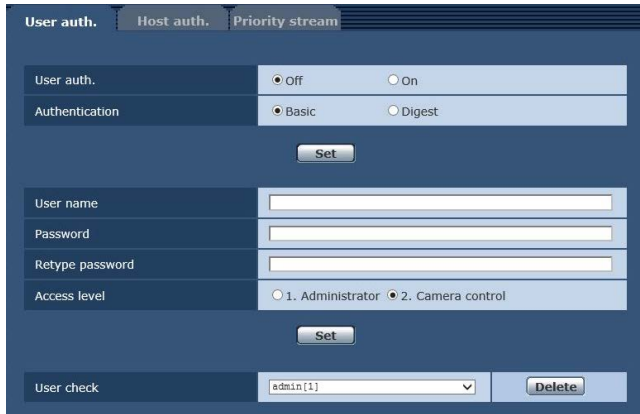

User auth.

User authorization is set to “Off” or “On” here. Enter the setting using the [Set] button.

Factory settings: Off

Authentication

Specify the method of user authentication to use. Enter the setting using the [Set] button.

Setting value:

Basic	Use basic authentication.
Digest	Use digest authentication.

Factory settings: Basic

Note

- If you change the Authentication setting, close the browser and perform access again.

User name [1 to 32 half-size characters]

The user name is input here.

Enter the setting using the [Set] button.

- The following characters can be displayed.

Half-size numeric characters	0123456789
Half-size alphabetical characters (upper and lower cases)	ABCDEFGHIJKLMNOPQRSTUVWXYZ abcdefghijklmnopqrstuvwxyz
Symbols	!#\$%&'()*+,-./=:?@[^_`{ }~

Password

Retype password [4 to 32 half-size characters]

The password is input here.

Enter the setting using the [Set] button.

Access level

Select one of the following settings as the user access level.

Enter the setting using the [Set] button.

Setting value:

1. Administrator	This access level allows the user to perform all the unit's operations.
2. Camera control	This access level allows only Live screen operations to be performed.

Factory settings: 2. Camera control

User check

You can view registered users by clicking for [User check].

A registered user is indicated in the form of “Registered user name [Access level]”. (Example: admin [1])

To delete a registered user, select the user to be deleted, and click the [Delete] button on the right.

Up to 9 users can be registered as users.

Web screen configurations (continued)

■ Host authentication settings tab [Host auth.]

Click the [Host auth.] tab of User mng. screen [User mng.].
Configure the host authorization settings that restrict the personal computers (IP addresses) that can access the unit.

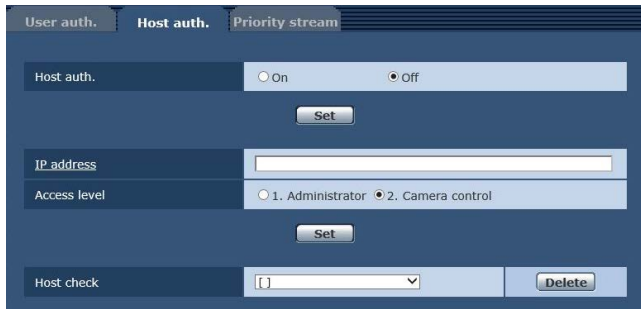

Host auth.

Host authorization is set to “On” or “Off” here.
Enter the setting using the [Set] button.
Factory settings: Off

IP address

The IP address of the personal computer from which access to the camera is allowed is input here. The host name cannot be input as the IP address.

Notes

- When the “IP address/subnet mask length” is input, the personal computers which are allowed to access the camera can be restricted on a subnet by subnet basis.
If, for instance, “192.168.0.1/24” has been input and the [2. Camera control] setting has been selected as the [Access level] setting, the personal computers from “192.168.0.1” to “192.168.0.254” will be able to access the camera at the [2. Camera control] access level.
- When an already registered IP address is input and the [Set] button is clicked, the host information will be overwritten.

Access level

Select one of the following settings as the host access level.
Enter the setting using the [Set] button.

Setting value:

1. Administrator	This access level allows the user to perform all the unit’s operations.
2. Camera control	This access level allows you to display images and control the unit. The unit cannot be set.

Factory settings: 2. Camera control

Host check

You can view registered host IP addresses by clicking for [Host check].

A host is indicated in the form of “Registered IP address [Access level]”. (Example: 192.168.0.21 [1])

You can delete selected hosts (IP addresses) by clicking the [Delete] button at the right.

■ Priority stream settings tab [Priority stream]

Click the [Priority stream] tab of User mng. screen [User mng.].

Selected on this screen are the settings for the priority stream which enables the images to be sent with no reduction in image quality or image refresh speed even when a multiple number of users are accessing the unit at the same time.

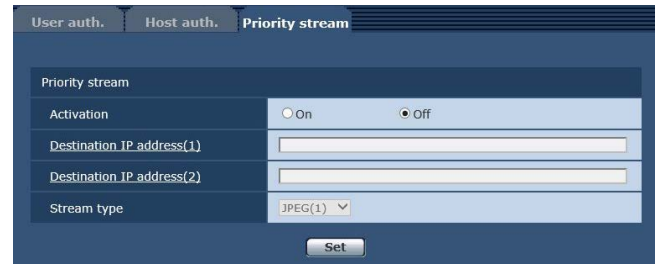

● Priority stream

Activation

Whether to use priority stream transmission is set here using “On” or “Off”.

Enter the setting using the [Set] button.

Factory settings: Off

Note

- When [Activation] is set to [On], the number of users that can access the unit may be restricted.

Destination IP address(1)

The IP address of the first send destination is input here.

Destination IP address(2)

The IP address of the second send destination is input here.

Stream type

Select the stream type.

Enter the setting using the [Set] button.

Setting value:

JPEG(1)	JPEG(1) images are sent.
JPEG(2)	JPEG(2) images are sent.
JPEG(3)	JPEG(3) images are sent.
H.264(1) Windows	H.264(1) images are sent.
H.264(2) Windows	H.264(2) images are sent.
H.264(3) Windows	H.264(3) images are sent.
H.264(4) Windows	H.264(4) images are sent.

Factory settings: JPEG(1)

Note

- When IP video transmission continues for more than 8 hours (approximately), video transmission from the unit may stop momentarily.

Web screen configurations (continued)

Network setup screen [Network]

Configure network settings in the Network setup screen. The Network setup screen consists of the two tabs of [Network] and [Advanced].

■ Network setup tab [Network]

Click the [Network] tab of the Network setup screen [Network].

This item's setting is reflected when the [Set] button is pressed.

IPv4 network	
DHCP	<input type="radio"/> On <input checked="" type="radio"/> Off
IP address(IPv4)	192 . 168 . 0 . 10
Subnet mask	255 . 255 . 255 . 0
Default gateway	192 . 168 . 0 . 1
DNS	<input checked="" type="radio"/> Auto <input type="radio"/> Manual
Primary server address	
Secondary server address	

IPv6 network	
Manual	<input type="radio"/> On <input checked="" type="radio"/> Off
IP address(IPv6)	
Default gateway	
DHCPv6	<input type="radio"/> On <input checked="" type="radio"/> Off
Primary DNS server address	
Secondary DNS server address	

Common	
HTTP port	80 (1-65535)
Max RTP packet size	<input checked="" type="radio"/> Unlimited(1500byte) <input type="radio"/> Limited(1280byte)
HTTP max segment size(MSS)	Unlimited(1460byte)
Bandwidth control (bitrate)	Unlimited
Easy IP Setup accommodate period	<input checked="" type="radio"/> 20min <input type="radio"/> Unlimited

The following information is required to configure network settings. Consult your network administrator or Internet service provider.

- IP address
- Subnet mask
- Default gateway (when using a gateway server or router)
- HTTP port
- DNS primary and secondary server addresses (when using DNS)

● IPv4 network

DHCP

Whether the DHCP function is to be used is set by selecting "On" or "Off" here. Configure the DHCP server so that the same IP address is not configured for a personal computer that does not use the DHCP function and other network cameras. For details on server settings, consult your network administrator.

Factory settings: Off

IP address(IPv4)

Input the unit's IP address here when the DHCP function is not going to be used. Input an address that will not duplicate an existing IP address which has been set for a personal computer or another network camera.

Factory settings: 192.168.0.10

Note

- Multiple IP addresses cannot be used even when the DHCP function is used. For details on the DHCP server settings, consult your network administrator.

Subnet mask

Input the unit's subnet mask here if the DHCP function is not going to be used.

Factory settings: 255.255.255.0

Default gateway

Input the unit's default gateway if the DHCP function is not going to be used.

Factory settings: 192.168.0.1

Note

- Multiple IP addresses cannot be used for the default gateway even when the DHCP function is used. For details on the DHCP server settings, consult your network administrator.

Web screen configurations (continued)

DNS

Whether the DNS server address is to be acquired automatically (Auto) or manually (Manual) is input here. If "Manual" has been selected, the DNS settings must be established.

If "Auto" is selected when the DHCP function is going to be used, the DNS server address is acquired automatically.

For further details, consult your system administrator.

Setting value: Auto, Manual

Factory settings: Manual

Primary server address

Secondary server address

Input the IP address of the DNS server if the "Manual" setting has been selected for "DNS".

For details on the IP address of the DNS server, consult your system administrator.

● IPv6 network

Manual

Enable or disable manual configuration of the IPv6 address.

Factory settings: Off

IP address(IPv6)

When [Manual] is set to [On], the IPv6 address must be entered manually.

Be sure to enter an address unique from other devices.

Note

- When connecting to the manually specified IP address through a router, use an IPv6-compatible router, and enable the automatic configuration function for the IPv6 address. Be sure to configure an IPv6 address that includes the prefix information provided by the IPv6-compatible router. For details, refer to the operating instructions for the router.

Default gateway

When [Manual] is set to [On] for IPv6 network, enter the default gateway for the unit's IPv6 network.

Factory settings: blank

DHCPv6

Enable or disable use of the IPv6 DHCP function.

Configure the DHCP server so that the same IP address is not configured for a personal computer that does not use the DHCP function and other network cameras.

For details on server settings, consult your network administrator.

Factory settings: Off

Primary DNS server address

Secondary DNS server address

Enter the IPv6 address of the DNS server.

For details on the IPv6 address of the DNS server, consult your system administrator.

Note

- A total of four DNS server addresses can be specified in IPv4 and IPv6 format together. However, if IPv4 addresses are set first, the maximum number of addresses that can be set is 3.

Web screen configurations (continued)

● Common (to IPv6/IPv4)

HTTP port

Port numbers are allocated separately.

Setting range: 1 to 65535

The following port numbers are used by the unit so they cannot be used.

20, 21, 23, 25, 42, 53, 67, 68, 69, 110, 123, 161, 162, 443, 554, 995, 10669, 10670, 59000 to 61000

Factory settings: 80

Max RTP packet size

Specify whether to limit the size of RTP packets sent from the camera when using RTP to view camera images.

Setting value:

Unlimited(1500byte)	Unlimited (1500 byte)
Limited(1280byte)	Limited (1280 byte)

Factory settings: Unlimited(1500byte)

Normally, it is recommended that the [Unlimited(1500byte)] setting be used.

Select [Limited(1280byte)] when the packet size of the used communication line is limited. For details on the maximum packet size of communication lines, consult your network administrator.

HTTP max segment size(MSS)

Select whether to limit the maximum segment size (MSS) transmitted by a camera when viewing camera images using HTTP.

Setting value:

Unlimited(1460byte)	Unlimited (1460 byte)
Limited(1280byte)	Limited (1280 byte)
Limited(1024byte)	Limited (1024 byte)

Factory settings: Unlimited(1460byte)

Normally, it is recommended that the default setting be used.

Select [Limited(1024byte)] / [Limited(1280byte)] when the maximum segment size (MSS) of the used communication line is limited. For details on the maximum segment size (MSS) of communication lines, consult your network administrator.

Bandwidth control (bitrate)

Select the amount of data to be distributed.

Setting value:

Unlimited, 1024kbps, 2048kbps, 4096kbps, 8192kbps, 16384kbps, 32768kbps

Factory settings: Unlimited

Easy IP Setup accommodate period

Select "20min" or "Unlimited" as the time for enabling the operation of the network settings from the Easy IP Setup Software.

Setting value:

20min	The setting operations from the Easy IP Setup Software are enabled for 20 minutes after the camera has started operating.
Unlimited	The setting operations from the Easy IP Setup Software are enabled at all times.

Factory settings: 20min

Web screen configurations (continued)

Recommended network setting for internet

Perform the recommended settings to connect the camera to the Internet.

Clicking the [Set] button displays a dialog box telling the user that item settings will be changed. After confirming this, click the [OK] button.

Note

- When the Priority Mode (page 56, page 77) selection is “NDI|HX”, this function is disabled.

• [JPEG/H.264] tab of camera screen [Image/Audio]

HDR	Off	“Low” or “High”
JPEG(1)	Image capture size: 640×360	Image capture size: 640×360
JPEG(2)	Image capture size: 320×180	JPEG transmission: Off
JPEG(3)	JPEG transmission: Off	JPEG transmission: Off
H.264(1)* Windows	Internet mode (over HTTP): On	Internet mode (over HTTP): On
	Image capture size: 1280×720	Image capture size: 640×360
	Max bit rate (per client): Max 8192 kbps, Min 2048 kbps	Max bit rate (per client): Max 4096 kbps, Min 1024 kbps
	Transmission priority: Best effort	Transmission priority: Best effort
H.264(2)* Windows	Internet mode (over HTTP): On	H.264 transmission: Off
	Image capture size: 640×360	
	Max bit rate (per client): Max 4096 kbps, Min 1024 kbps	
	Transmission priority: Best effort	
H.264(3)* Windows	Internet mode (over HTTP): On	H.264 transmission: Off
	Image capture size: 320×180	
	Max bit rate (per client): Max 4096 kbps, Min 512 kbps	
	Transmission priority: Best effort	
H.264(4)* Windows	H.264 transmission: Off	

* Cannot be selected when the Priority Mode is other than “IP” because IP transmission of H.264 images is not supported.

• “Network” tab in the Network setting screen

Common IPv6/IPv4	Max RTP packet size: Limited(1280byte)
	HTTP max segment size(MSS): Limited(1280byte)

Web screen configurations (continued)

Advanced network setting tab

[Advanced]

Click the [Advanced] tab in the network setup screen [Network].

Settings relating to the FTP, NTP, UPnP, and HTTPS functions are performed here.

Click the links to each item to move to the respective setting page.

FTP

Configure settings related to the FTP server.

This item's setting is reflected when the [Set] button is pressed.

Notes

- CGI control from an external device is required to use the FTP function.
- To use the FTP function, set the priority mode to "SD card". For details, refer to "Priority mode tab [Priority mode]" (page 77).
- When data is being transferred to an FTP server, recording to and playback from an SD card are not possible. Also, the Play List screen cannot be displayed.

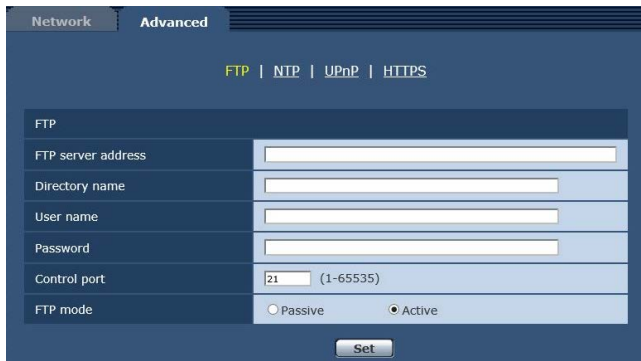

FTP server address

Enter the IP address or host name of the FTP server to which image data is to be sent.

Maximum number of characters	0 to 128 half-size characters
Characters that can be entered	Half-size alphanumeric characters, half-size symbols : . _ -

Factory settings: blank

Note

- To enter the host name of [FTP server address], you need to configure the [DNS] settings on the [Network] tab of the network setup screen [Network]. (page 104)

Directory name

Enter the name of the directory to save the video data to be sent.

Maximum number of characters	0 to 256 half-size characters
Characters that can be entered	Half-size alphanumeric characters, half-size symbols However, the following characters cannot be entered. " & :

Factory settings: blank

User name

Enter the user name (login name) for accessing the FTP server.

Maximum number of characters	0 to 32 half-size characters
Characters that can be entered	Half-size alphanumeric characters, half-size symbols However, the following characters cannot be entered. " & ; ¥

Factory settings: blank

Password

Enter the password for accessing the FTP server.

Maximum number of characters	0 to 32 half-size characters
Characters that can be entered	Half-size alphanumeric characters, half-size symbols However, the following characters cannot be entered. " &

Factory settings: blank

Note

- When you enter a password and click the [Set] button, nothing is displayed in the input field but the setting is complete.

Control port

Enter the port number for FTP server control.

Port Nos. that can be selected: 1 to 65535

The following port numbers are used by the unit so they cannot be used.

20, 23, 25, 42, 53, 67, 68, 69, 80, 110, 123, 161, 162, 443, 554, 995, 10669, 10670, 59000 to 61000

Factory settings: 21

FTP mode

Select the FTP communication mode from Passive mode and Active mode.

Factory settings: Active

Web screen configurations (continued)

● NTP

Settings relating to the NTP server address and port No. are performed.
This item's setting is reflected when the [Set] button is pressed.



Synchronization with NTP

Set whether to use an NTP server by selecting “On” or “Off”.

Setting value:

On	Uses an NTP server. (Synchronizes the date and time with the NTP server.)
Off	Does not use an NTP server.

Factory settings: Off

NTP server address setting

Select the method to acquire the NTP server address.

Setting value:

Auto	Acquires the NTP server address from the DHCP server.
Manual	Sets the address by inputting the NTP server address in [NTP server address].

Factory settings: Manual

Note

- To acquire the NTP server address from the DHCP server, you need to set “DHCP” (page 103) of “IPv4 network” on the [Network] tab of the network setup screen [Network] to “On”.

NTP server address

When [Manual] is selected in the [NTP server address setting], input the IP address or host name of the NTP server.

Maximum number of characters	0 to 128 half-size characters
Characters that can be entered	Half-size alphanumeric characters, half-size symbols : . _ -

Factory settings: blank

Note

- To input the [NTP server address] host name, the [DNS] setting must be selected on the [Network] tab of the network setup screen [Network] (page 104).

NTP port

Input the port No. of the NTP server.

Port Nos. that can be selected: 1 to 65535

The following port numbers are used by the unit so they cannot be used.

20, 21, 23, 25, 42, 53, 67, 68, 69, 80, 110, 161, 162, 443, 554, 995, 10669, 10670, 59000 to 61000

Factory settings: 123

Time adjustment interval

Selects the interval (1 to 24 hours in 1-hour increments) for acquiring the time from the NTP server.

Setting range: 1h to 24h

Factory settings: 1h

Web screen configurations (continued)

● UPnP

This unit supports UPnP (Universal Plug and Play). Using the UPnP function allows the following to be set automatically.

This item's setting is reflected when the [Set] button is pressed.

- Sets the router's port forwarding function. (However, a UPnP-compatible router is necessary.)
This setting is useful when accessing the camera from the Internet or a portable terminal.



Auto port forwarding

Whether to use the router's port forwarding function is set by selecting "On" or "Off".

To use the automatic port forwarding function, the used router must support UPnP and the UPnP function must be enabled.

Factory settings: Off

Notes

- The port number may be changed by automatic port forwarding. If the number is changed, the port No. of the camera registered to the personal computer or recorder must be changed.
- The UPnP function may be used when the camera is connected to the IPv4 network. IPv6 is not supported.
- To confirm that automatic port forwarding is correctly set, click the [Status] tab in the maintenance screen [Maintenance] to confirm that the [UPnP] status is set to [Enable]. (page 121)
If [Enable] is not displayed, refer to "No access is possible from the web browser" in the "Troubleshooting" (page 141).

● HTTPS

Using the HTTPS function enables access to the camera to be encrypted and communication safety to be improved. See page 111 for more details on the HTTPS setup method.

This item's setting is reflected when the [Set] button is pressed.

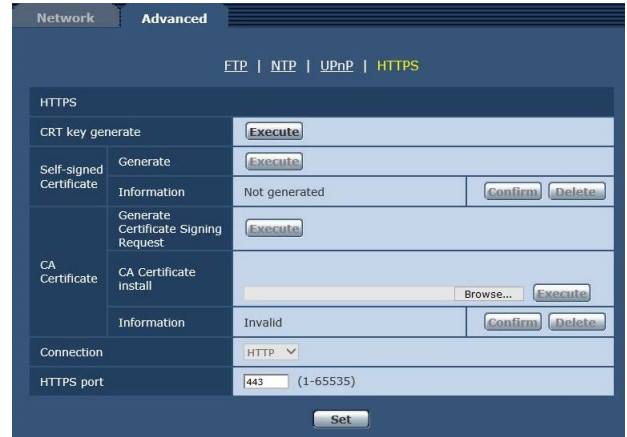

CRT key generate

A CRT key (SSL encryption key) is generated by HTTPS. To generate a CRT key, click the [Execute] button to display the [CRT key generate] dialog.

For more details, refer to "Generating a CRT key (SSL encryption key)" (page 112).

Self-signed Certificate - Generate

A self-signed security certificate is generated by HTTPS. (Self-signed Certificate)

To generate a self-signed certificate (security certificate), click the [Execute] button to display the [Self-signed Certificate - Generate] dialog and perform the operation. For more details, refer to "Generating a self-signed certificate" (page 113).

Self-signed Certificate - Information

This displays information relating to the self-signed certificate (security certificate).

When the [Confirm] button is clicked, the registered content of the generated self-signed certificate (security certificate) is displayed in the [Self-signed Certificate - Confirm] dialog.

Click the [Delete] button to delete the generated self-signed certificate (security certificate).

Web screen configurations (continued)

CA Certificate - Generate Certificate Signing Request

When using a security certificate issued by the Certificate Authority (CA) as a security certificate for HTTPS, a Certificate Signing Request (CSR) is generated for application to the Certificate Authority (CA).

To generate a Certificate Signing Request (CSR), click the [Execute] button to display the [CA Certificate - Generate Certificate Signing Request] dialog and perform the operation.

For more details, refer to "Generating a Certificate Signing Request (CSR)" (page 114).

CA Certificate - CA Certificate install

This displays information relating to server certificates (security certificates) issued by the Certificate Authority (CA), which are to be or are already installed.

In the [File Open] dialog, which is displayed by clicking the [Browse] button, select the file of the server certificate (security certificate) issued by the Certificate Authority (CA) and click the [Execute] button to install the server certificate (security certificate).

If the server certificate (security certificate) is installed, its file name will be displayed.

For more details, refer to "Installing a Server Certificate" (page 115).

CA Certificate - Information

This displays information relating to the server certificate (security certificate).

When the [Confirm] button is clicked, the registered content of the installed server certificate (security certificate) is displayed in the [CA Certificate - Confirm] dialog. If the server certificate (security certificate) is not installed, the content of the generated Certificate Signing Request (CSR) is displayed.

Click the [Delete] button to delete the installed server certificate (security certificate).

Note

- To delete an enabled server certificate (security certificate), confirm that there is a backup to the said certificate in your personal computer or recording media. A server certificate (security certificate) will be needed to reinstall it.

Connection

This sets the method to connect to the unit.

Setting value:

HTTP	Only HTTP connection is possible.
HTTPS	Only HTTPS connection is possible.

Factory settings: HTTP

For more details, refer to "Setting the Connection Method" (page 116).

Note

- When using an HTTPS connection, network connection with the AW-RP50 will be disabled.

HTTPS port

This sets the Port No. to be used with HTTPS.

Port Nos. that can be selected: 1 to 65535

The following port numbers are used by the unit so they cannot be used.

20, 21, 23, 25, 42, 53, 67, 68, 69, 80, 110, 123, 161, 162, 554, 995, 10669, 10670, 59000 to 61000

Factory settings: 443

Notes

- This unit will restart if the connection method is changed.
- When using a self-signed certificate:
A warning screen is displayed when accessing the camera by HTTPS for the first time. Install the self-signed certificate (security certificate) in your personal computer in accordance with the screen instructions. (page 117)
- When using a server certificate:
Install the Certificate Authority (CA) root certificate or intermediate certificate in your web browser in advance.
Follow the Certificate Authority (CA) procedures to acquire and install root certificates and intermediate certificates.
- When accessing the camera by HTTPS, the image display speed and frame rate of the moving image may reduce.
- When accessing the camera by HTTPS, it may take some time for the images to be displayed.
- When accessing the camera by HTTPS, images may be disturbed and sound may be interrupted.
- The maximum number of cameras that can be connected simultaneously depends on the maximum image size and distribution format.

Web screen configurations (continued)

■ HTTPS settings [HTTPS]

This encrypts access to the camera and sets HTTPS to improve communication safety. Setting HTTPS is performed by following the procedures below.

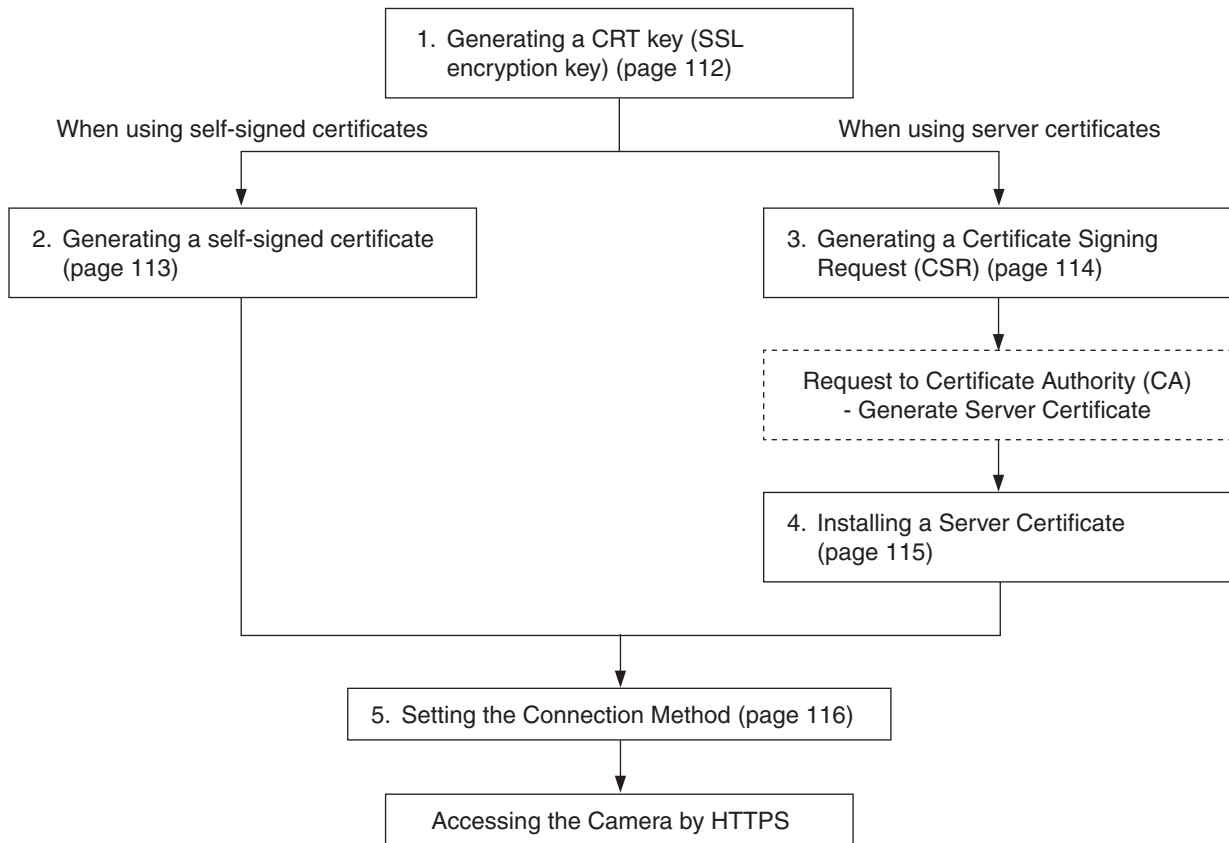
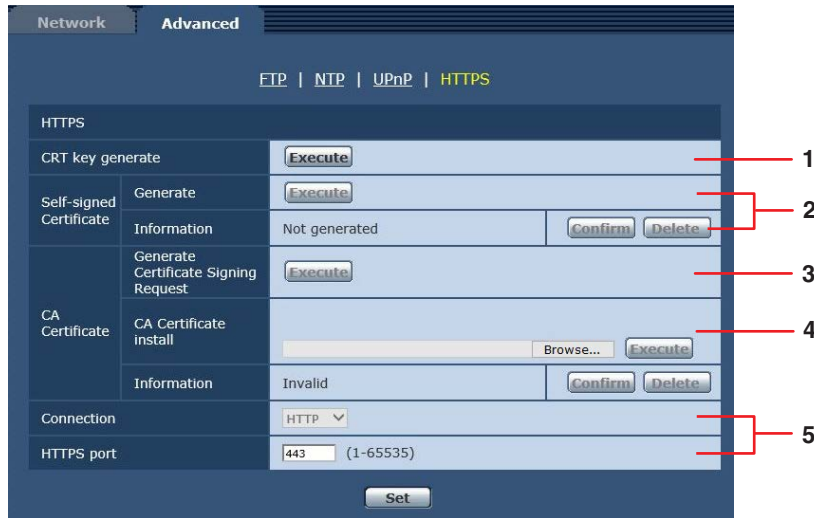

Notes

- When using a server certificate, the process from applying to the Certificate Authority (CA) to issuing a server certificate must be performed between customers and the Certificate Authority (CA).
- Use either a self-signed certificate or server certificate. When simultaneously generating a self-signed certificate and installing a server certificate, this unit will prioritize the server certificate.

Web screen configurations (continued)

■ Generating a CRT key (SSL encryption key) [CRT key generate]

Notes

- A CRT key cannot be generated when self-signed certificates and server certificates are enabled.
- The size of the key that can be used by the Certificate Authority (CA) differs when using a server certificate. Confirm in advance the size of the key that can be used.
- Generating a CRT key takes about 1 minute for 1024 bit and about 2 minutes for 2048 bit. Do not operate the web browser until CRT key generation is complete. Image display and communication speed may reduce while generating a CRT key.

1. Click the [Execute] button in [CRT key generate].
The [CRT key generate] dialog is displayed.



2. The size of the generated CRT key is selected from [1024bit] / [2048bit] in [CRT key generate] – [RSA key size].

Note

- When using a server certificate, the RSA key size must be in accordance with the demands of the Certificate Authority (CA) which will be applied to.

3. Click the [Execute] button.

CRT key generation starts.

When CRT key generation is complete, the size of the CRT key generated by the [Current CRT key] and the date and time generation concluded will be displayed.

Notes

- Perform procedures 1 to 3 to change (update) the generated CRT key. Because the CRT key, self-signed certificate and server certificate are enabled as a set, it will be necessary to once again generate a self-signed certificate or apply for a server certificate when the CRT key is changed.
- When the CRT key is changed, previous CRT keys are historically managed one at a time. Clicking the [Apply] button in the [Current CRT key] of the [CRT key generate] dialog displays the [Previous CRT key] dialog, allowing confirmation of the key size and the date and time generation was completed. Clicking the [Apply] button in [Previous CRT key] allows the previous CRT key to be switched to the current CRT key.



Web screen configurations (continued)

■ Generating a self-signed certificate [Self-signed Certificate - Generate]

Note

- A self-signed certificate cannot be generated when a CRT key has not been generated.

1. Click the [Execute] button in [Self-signed Certificate - Generate].

[Self-signed Certificate - Generate] is displayed.

2. Input information relating to the certificate to be generated.

Items to be entered are as follows.

Item	Description	Maximum number of characters
Common Name	Inputs the camera address or host name.	64 half-size characters
Country	Inputs the country code. (can be abbreviated)	2 half-size characters: country code
State	Inputs the name of the state. (can be abbreviated)	128 half-size characters
Locality	Inputs the name of the city. (can be abbreviated)	128 half-size characters
Organization	Inputs the name of the organization. (can be abbreviated)	64 half-size characters
Organizational Unit	Inputs the name of the organizational unit. (can be abbreviated)	64 half-size characters
CRT key	Displays the size of the current CRT key and the date and time generation was completed.	—

Notes

- Characters that can be input for [Common Name], [Country], [State], [Locality], [Organization], [Organizational Unit] are 0 to 9 (half-size characters), A to Z (half-size characters), a to z (half-size characters), and the following half-size symbols: - , _ , + / ().
- When connecting the camera to the Internet, set the address or host name to be accessed from the Internet in [Common Name]. In this case, when accessing the camera locally, a security warning screen is displayed every time the camera is accessed even when a security certificate is installed.
- When inputting the IPv6 address in [Common Name], surround the address with []. e.g. [2001:db8::10]

3. Click the [OK] button after inputting the address. A self-signed certificate is generated.

Notes

- Information relating to the generated self-signed certificate is displayed in [Self-signed Certificate] - [Information]. The following is displayed depending on the status of the self-signed security certificate.

Displayed content	Description
Not generated	When the self-signed certificate is not generated
Invalid (Reason: CA Certificate installed)	When the self-signed certificate is already generated and the server certificate is already installed <ul style="list-style-type: none"> • The server certificate is enabled in this case.
[Common Name] of self-signed certificate	When the self-signed certificate is already generated and enabled

- When the [Confirm] button is clicked, the registered content of the generated self-signed certificate (security certificate) is displayed in the [Self-signed Certificate - Confirm] dialog.

- Click the [Delete] button to delete the generated self-signed certificate (security certificate).
- When [HTTPS] is selected in [Connection], the self-signed certificate (security certificate) cannot be deleted.

Web screen configurations (continued)

■ Generating a Certificate Signing Request (CSR) [CA Certificate - Generate Certificate Signing Request]

Notes

- A certificate signing request (CSR) cannot be generated if a CRT key has not been generated.
- To generate a certificate signing request (CSR), perform the following settings in advance in the web browser Internet options. Perform the following settings in the [Security] tab (accessed from [Tools] in the menu bar - [Internet Options] - [Security]).
 - Register the camera as a [Trusted Site].
 - In [Level Customize], go to [File Download] from [Download] and set to [Enable].
 - In [Level Customize], go to [Automatically Display Dialog when Downloading File] from [Download] and set to [Enable].

1. Click the [Execute] button in [CA Certificate - Generate Certificate Signing Request].

The [CA Certificate - Generate Certificate Signing Request] dialog is displayed.

2. Input information relating to the certificate to be generated.

Items to be entered are as follows.

Item	Description	Maximum number of characters
Common Name	Inputs the camera address or host name.	64 half-size characters
Country	Inputs the country code.	2 half-size characters: country code
State	Inputs the name of the state.	128 half-size characters
Locality	Inputs the name of the city.	128 half-size characters
Organization	Inputs the name of the organization.	64 half-size characters
Organizational Unit	Inputs the name of the organizational unit.	64 half-size characters
CRT key	Displays the size of the current CRT key and the date and time generation was completed.	—

Notes

- When using a server certificate, the information to be input must be in accordance with the demands of the Certificate Authority (CA), which will be applied to.
- Characters that can be input for [Common Name], [Country], [State], [Locality], [Organization], [Organizational Unit] are 0 to 9 (half-size characters), A to Z (half-size characters), a to z (half-size characters), and the following half-size symbols: - , _ , + / () .

3. Click the [OK] button after inputting the address.

The [Save As] dialog is displayed.

4. In the [Save As] dialog, assign a file name to the Certificate Signing Request (CSR) and save it in personal computer.

Apply to the Certificate Authority (CA) using the saved Certificate Signing Request (CSR).

Notes

- A server certificate is issued for both the generated Certificate Signing Request (CSR) and CRT key. The issued server certificate can no longer be used when generating/updating the CRT key after applying to the Certificate Authority (CA).
- The Certificate Signing Request (CSR) generated by this unit is in a PEM format.

Web screen configurations (continued)

■ Installing a Server Certificate [CA Certificate - CA Certificate install]

Notes

- A server certificate (security certificate) cannot be installed if a Certificate Signing Request (CSR) has not been generated.
- The server certificate must have been issued by the Certificate Authority (CA) in order to install it.

1. Click the [Browse] button in [CA Certificate - CA Certificate install].

The [Open File] dialog is displayed.

2. Select the server certificate file and click [Open]. Then click the [Execute] button.

The server certificate is installed.

Notes

- The name of the host registered to the installed server certificate is displayed in [CA Certificate] - [Information]. The following is also displayed depending on the status of the server certificate.

Displayed content	Description
Invalid	When the server certificate is not installed
[Common Name] of server certificate	When the server certificate is already installed and enabled
Expired	When the effective period of the server certificate has expired

- When the [Confirm] button is clicked, the content of the installed server certificate (security certificate) is displayed in the [CA Certificate - Confirm] dialog. (An asterisk is displayed in the [Organizational Unit] field only.)



- Click the [Delete] button to delete the installed server certificate (security certificate).
- When [HTTPS] is selected in [Connection], the server certificate (security certificate) cannot be deleted.
- Perform STEP 1 to STEP 2 to update a server certificate.
- To delete an enabled server certificate (security certificate), confirm that there is a backup to the said certificate in your personal computer or recording media. A server certificate (security certificate) will be needed to reinstall it.
- The HTTPS function can no longer be used when the effective period of the server certificate has expired. In such a case, the connection method is changed to HTTP when the unit is restarted. Update the server certificate before its effective period expires.
- The effective period of the server certificate can be confirmed by double-clicking the server certificate file issued by the Certificate Authority (CA).

Web screen configurations (continued)

■ Setting the Connection Method [Connection]

1. Set the method to access the camera in [Connection].

HTTP: Only HTTP connection is possible.

HTTPS: Only HTTPS connection is possible.

Note

- When using an HTTPS connection, network connection with the AW-RP50 will be disabled.

2. Set the Port No. to be used with HTTPS in [HTTPS Port].

Port Nos. that can be selected: 1 to 65535

The following port numbers are used by the unit so they cannot be used.

20, 21, 23, 25, 42, 53, 67, 68, 69, 80, 110, 123, 161, 162, 554, 995, 10669, 10670, 59000 to 61000

Factory settings: 443

3. Click the [Set] button.

The camera restarts and access to the camera via HTTPS is enabled.

Notes

- This unit will restart if the connection method is changed.
- **Using a self-signed certificate**
A warning screen is displayed when accessing the camera by HTTPS for the first time. Install the self-signed certificate (security certificate) in your personal computer in accordance with the screen instructions. (page 117)
- **Using a server certificate**
Install the Certificate Authority (CA) root certificate or intermediate certificate in your web browser in advance. Follow the Certificate Authority (CA) procedures to acquire and install root certificates and intermediate certificates.
- When accessing the camera by HTTPS, the image display speed and frame rate of the moving image may reduce.
- When accessing the camera by HTTPS, it may take some time for the images to be displayed.
- When accessing the camera by HTTPS, images may be disturbed and sound may be interrupted.
- The maximum number of cameras that can be connected simultaneously depends on the maximum image size and distribution format.

■ Accessing the Camera by HTTPS

1. Launch the web browser in your personal computer.

2. Input the camera's IP address in the address bar of the web browser.

Example of input: `https://192.168.0.10/`

Notes

- When the HTTPS port No. is changed from "443", input "https://camera IP address: Port No." in the address bar.
E.g. `https://192.168.0.11:61443`
- When this unit is in a local network, set a proxy server from the web browser (menu bar: [Tools] - [Internet Options]) to ensure that a proxy server is not used for a local address.

3. Press the [Enter] key.

The Live screen is displayed.

The security certificate is installed when the security warning screen is displayed. (page 117)

When [User auth.] is set to [On], the user name and password input screen is displayed before the live screen appears.

Note

- When HTTPS is used, screen and image display may slow down and image update interval (frame rate) may also slow down.

Web screen configurations (continued)

● Install the security certificate

When using HTTPS to access the camera, the security warning screen will be displayed if the security certificate of the said camera has not been installed in your personal computer. To prevent this warning screen being displayed, the security certificate must be installed in accordance with the following procedures. If it is not installed, the security warning screen will be displayed every time the camera is accessed.

Notes

- The security certificate will be installed to your personal computer based on the content set for [Common Name]. The content set for the “Host Name” must therefore match that set for the address/host name used to access the camera. If the content differs, a security warning screen will be displayed every time the camera is accessed.
- A security warning screen will be displayed if the camera address/host name is changed even when a security certificate has been installed. Reinstall the security certificate.
- When connecting the camera to the Internet, set the address or host name to be accessed from the Internet in [Common Name]. In this case, when accessing the camera locally, a security warning screen is displayed every time the camera is accessed even when a security certificate is installed.
- When the security certificate is correctly installed, an icon of the key will be displayed in the address bar of the web browser accessing the camera. (in the case of Internet Explorer 8.0 and 9.0)
- The screen will differ partially in the case of Internet Explorer 10 and 11.

1. Accessing the Camera by HTTPS

2. When the security warning screen is displayed, click [Continue to this website (not recommended)].

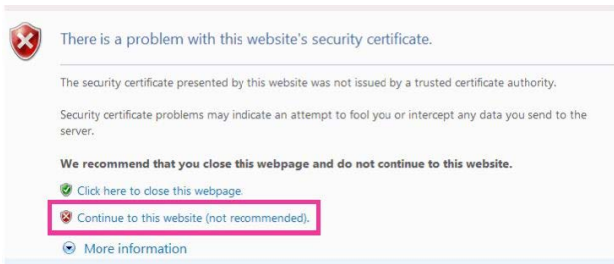

The live screen [Live] is displayed.

When the authentication screen is displayed, input the user name and password.

Note

- When the above screen is displayed after accessing a device apart from the camera or a website, there may be a security problem, so check this carefully.

3. Click [Certificate Error] in the URL and then click [View certificates].

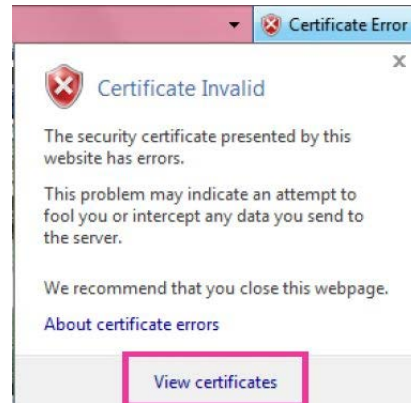

4. Click [Install Certificate...].

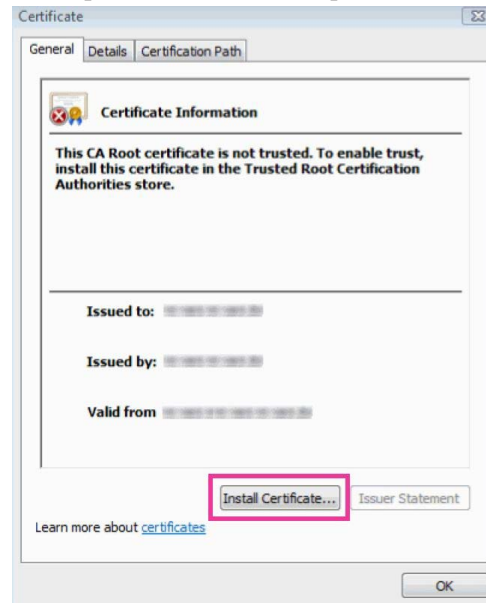

Notes

- If [Install Certificate...] is not displayed, close Internet Explorer and restart it by selecting [Execute as Administrator (A)..]. Right-click on [Start] - [Program] - [Internet Explorer] and click [Execute as Administrator (A)..].
- In the case of Windows 8 and 8.1, right-click on [iexplore] under [C:\Program Files\Internet Explorer] and click [Execute as Administrator (A)..].

Web screen configurations (continued)

5. Click [Next], which is displayed in the certificate import wizard.

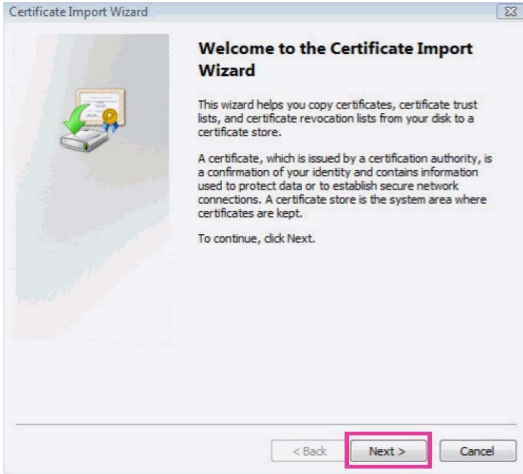

Note

- In the case of Internet Explorer 10 and 11, select the [Save destination] and click [Next].

6. Select [Place all certificates in the following store] and click [Browse].

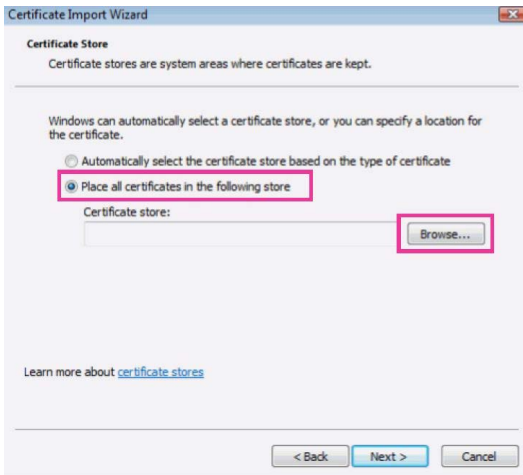

7. Select [Trusted Root Certification Authorities] and click [OK].

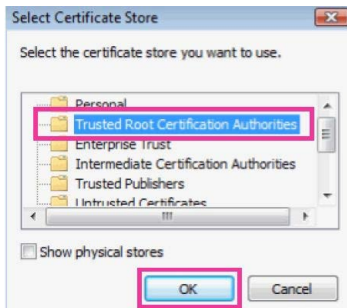

8. Click [Next].

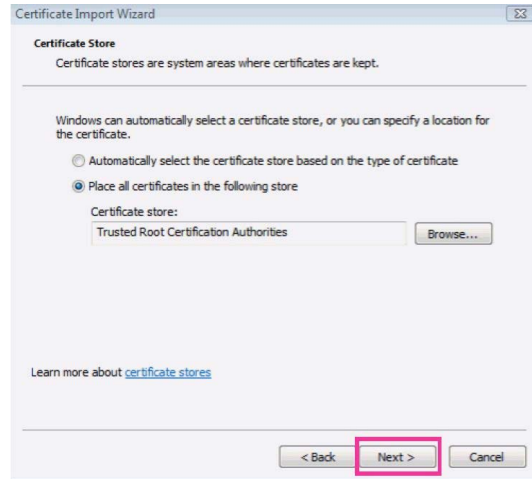

9. Click [Finish].

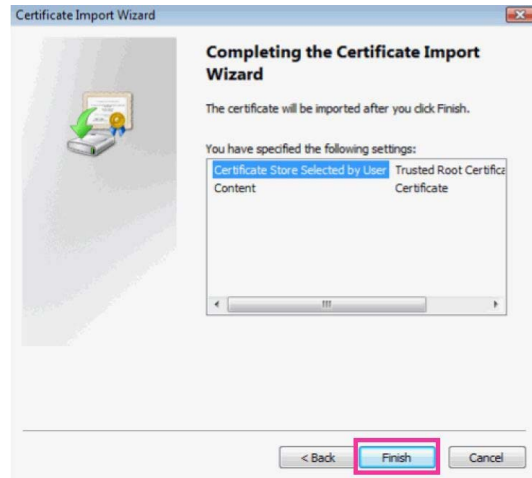

10. Click [Yes].

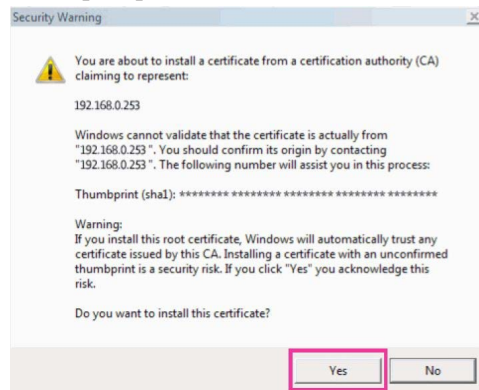

When importing is finished, the "The import was successful." screen is displayed.

11. Click [OK].



Closing the web browser after importing the certificate and reconnecting to it will stop the "Certificate error" screen being displayed.

Web screen configurations (continued)

Maintenance screen [Maintenance]

Among the various maintenance operations performed on this screen are system log checks, system version upgrading and initialization of the unit.

The Maintenance screen consists of six tabs: [System log], [Product info.], [Status], [Default reset], [Backup] and [Activate].

System log tab [System log]

Up to 100 event logs and up to 32 error logs can be saved to the internal memory of the unit.

When this maximum number has been exceeded, the old logs are overwritten successively by the new logs.

The logs are maintained even if the unit's power is turned off.

- The event logs are always displayed when the System log screen is displayed.

No	Date & Time	Event code	Description
1	DEC/12/2015 00:00	W1105	<SD Card> Rec stop.
2	DEC/12/2015 00:00	W1104	<SD Card> Rec start.
3	DEC/12/2015 00:00	W1101	<SD Card> No Card.
4	DEC/12/2015 00:00	W1101	<SD Card> No Card.
5	DEC/12/2015 00:00	W0002	<Power> Power on.
6	DEC/12/2015 00:00	W0003	<Power> Standby.

System log

Switch the display between event logs and error logs.

Setting value:

Event log	Displays the event logs.
Error log	Displays the error logs.

[Event log]

No

Displays the log sequence numbers.

"1" indicates the latest information, and up to 100 logs can be saved.

Date & Time

Displays the dates and times when the events occurred.

The dates and times when the events occurred are indicated in 24-hour format according to the clock of the unit.

Event code

Displays the event code numbers.

Description

Displays the event descriptions.

Display examples:

- Rec stop.
- Rec start.
- No Card.
- Power on.

[Error log]

No	Operation time	Error code	Error description
1	62h	0x03	Motor Driver Error
2	32h	0x03	Motor Driver Error
3	30h	0x05	Tilt Sensor Error
4	2h	0x03	Motor Driver Error
5	0h	0x05	Tilt Sensor Error

No

Displays the log sequence numbers.

"1" indicates the latest information, and up to 32 logs can be saved.

Operation time

Displays the dates and times when the errors occurred.

The dates and times when the errors occurred are indicated with the hour meter (0h to 99999h) of the unit.

Error code

Displays the error code numbers.

Error description

Displays the error descriptions.

Display examples:

- Tilt Sensor Error
- Motor Driver Error

Web screen configurations (continued)

■ Product information tab [Product info.]

The versions of the unit's software can be checked on this screen.

The [Model no.], [MAC address], [Serial no.], [Firmware version] and other information about the unit is displayed.

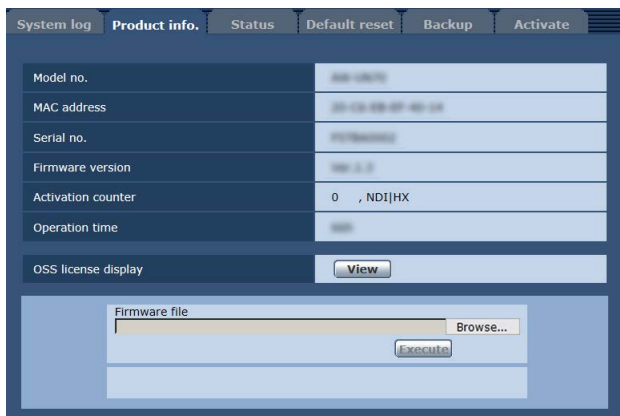

Model no.

The unit's model number is displayed here.

MAC address

The unit's MAC address is displayed here.

Serial no.

The unit's serial number is displayed here.

Firmware version

This displays the unit's firmware version.

Activation counter

Display the number of times activation has been performed.

The count is incremented when activation is successful. Activation can be performed by purchasing "Feature Upgrade" (paid upgrade). ("Activation" on page 137)

Operation time

Display the unit's total operating time. (Up to 99999h)

OSS license display

When you press the [View] button, the OSS license appears.

Press the [Close] button to close the OSS license display screen.

Firmware file

1. Download the latest software to your personal computer.

Note

- Keep the maximum combined number of characters to be used for the name of the directory in which the software will be stored and for the name of the software which has been downloaded to less than 250 characters.

2. Click the [Browse] button, and specify the downloaded software.

3. Click the [Execute] button.

The software upgrade check screen is displayed.

After upgrading the software version, be absolutely sure to delete the temporary Internet files.

Notes

- An upgrade progress bar appears after you click the [Execute] button, and the process will take about 1 minute.
- Use the personal computer on the same subnet as the camera to upgrade the software version.
- Before using the version upgrading software, be absolutely sure to check the precautions to be observed, and follow the instructions.
- Use the following files specified by Panasonic Corporation as the software used for version upgrading.

UPDATE.HDC

- Do not turn off the unit's power while a software version is being upgraded. (A pop-up screen will appear to indicate that the process is complete.)
- While a software version is being upgraded, do not attempt to execute any other operations until the version has been upgraded.
- Close the web browser once after performing a version upgrade.

Web screen configurations (continued)

■ Status confirmation tab [Status]

Confirm the status of the unit.



UPnP	
Port number(HTTP)	
Status	Disable
Port number(HTTPS)	
Status	Disable
Router global address	

● UPnP

Port number(HTTP)

Displays the port number configured via UPnP port forwarding.

Status

Displays the port forwarding status.

Port number(HTTPS)

Displays the port number configured via UPnP port forwarding.

Status

Displays the port forwarding status.

Router global address

Displays the global address of the router.

■ Reset settings tab [Default reset]

The unit's setting data is initialized and the unit is restarted on this screen.



Reset to the default (Except the network settings)

When the [Execute] button is clicked, the unit's settings are returned to their defaults.

The following settings are not initialized.

- All the settings under [Setup] → [Basic] → [Date&Time]
- The Horizontal Phase, Format and Frequency settings under [Setup] → [Image/Audio] → [System]
- All the settings under [Setup] → [Multi-screen]
- All the settings under [Setup] → [User mng.]
- All the settings under [Setup] → [Network]
- All the settings under [Setup] → [Maintenance]

When the initialization operation is started, no operations can be undertaken for about 1 minute.

Reboot

When the [Execute] button is clicked, the unit is rebooted. After the unit has been rebooted, no operations can be undertaken for about 1 minute as is the case when the unit's power is turned on.

Web screen configurations (continued)

■ Back up tab [Backup]

On this screen, the unit's settings can be saved to a personal computer or settings saved in a personal computer can be loaded into the unit for use.

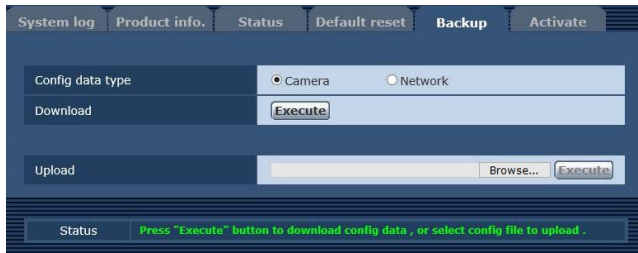

Config data type

Specify the type of settings to save when saving the unit's configuration data on the personal computer.

Setting value:

Camera	Camera settings
Network	<ul style="list-style-type: none"> • Network settings • Priority mode setting

Download

Save the unit's settings onto the personal computer.

When the destination dialog box appears after clicking the [Execute] button, specify the destination folder.

When [Camera] is selected in [Config data type], the following settings are saved.

File name	Settings
AW-HE42_CSetting.dat	Scene Scene1 settings Scene Scene2 settings Scene Scene3 settings Scene Scene4 settings System settings Preset settings

When [Network] is selected in [Config data type], the following settings are saved.

File name	Settings
AW-HE42_NSetting.dat	Settings of the Web screen Clock settings Network settings

Notes

- After the [Execute] button is clicked, the amount of time it takes for the destination dialog box to appear is about 10 seconds for a camera settings file and about 20 seconds for a network settings file.
- The unit may restart after download of settings files.
- Depending on the state of the unit (whether recording to the SD card is in progress), settings file downloading may not be possible. The unit will also restart automatically in such cases.

Upload

The unit's setting files, which were saved in the personal computer by the download function, are uploaded.

Click the [Browse] button to display the dialog box, and specify the saved file.

When you click the [OK] button in the message dialog box that appears after you click the [Execute] button, uploading starts.

Another message dialog box appears after uploading is complete. When you click the [OK] button, the unit will restart automatically.

Notes

- Use the files downloaded by the unit as the data to be used for uploading.
- If the file name of a settings file is changed, it may become impossible to upload.
- Do not turn off the unit's power while downloading or uploading is underway.
- Do not attempt to perform any operations while downloading or uploading is underway. Instead, wait until the downloading or uploading is completed.
- It takes about 2 minutes for the upload complete dialog box to appear for camera settings files.

Web screen configurations (continued)

■ Activate tab [Activate]

You can perform activation (register an unlock key code) to add available functions.

For details, refer to “Activation” (page 137).

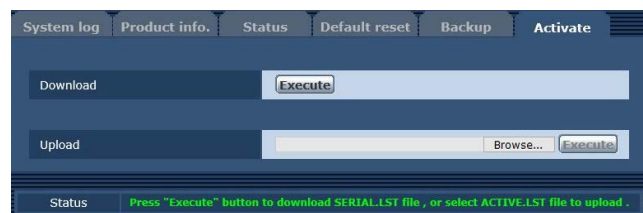

Download

Obtain the serial number and other information for the remote camera.

Upload

Upload an activation file to the unit.

Recording to and playing back from a memory card

The unit can record and playback in MP4 format to/from the following SD cards compliant with the SD standards.

- Set the priority mode to “SD card” before use. For details, refer to “Priority mode tab [Priority mode]” (page 77).

Notes

- IP control, IP video transmission, and PoE+ power supply can be used at the same time as these functions if you use a LAN cable. However, some limitations will occur to IP video transmission compared with when the priority mode is set to “IP”. For details, refer to “Priority mode (Priority Mode)” (page 30, page 56, page 77, page 130).
- When the priority mode is “SD card”, the IP transmission of H.264 images is not possible.

SD card type	Recording capacity	Speed class
microSDHC	4 GB to 32 GB	Speed class 10 or higher
microSDXC	64 GB to 128 GB	

- SD Speed Class Rating is the speed standard regarding continuous writing. Check via the label on the card, etc.

e.g.: **CLASS 10**

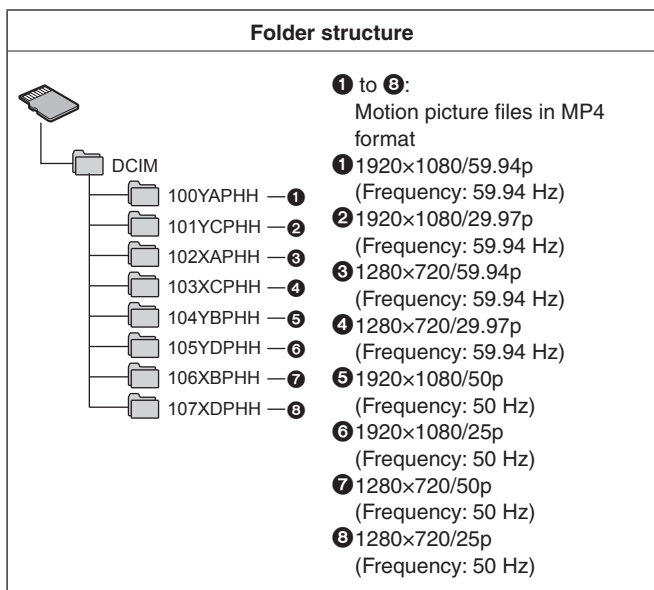

Note

- The folder names and file numbers are initialized each time an SD card is formatted (initialized).

Inserting and ejecting an SD card (optional accessory)

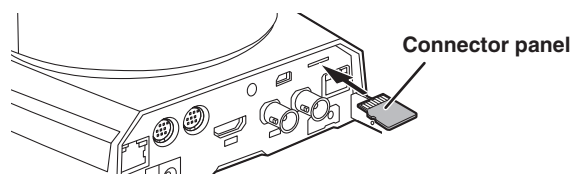

- Orient the connector panel in the direction shown in the diagram and then insert the SD card straight all the way in until you hear a click.
- To eject the SD card, push until you hear a click and then pull the SD card straight out.

Recording

When an SD card that has been used with another device is to be used with the unit for the first time, format (initialize) the SD card before use. Furthermore, when a commercially available SD card is to be used for the first time, be sure to format (initialize) it with the unit.

For details, refer to “Format” (page 79).

1. Set the priority mode to “SD card”.

- “Priority mode tab [Priority mode]” (page 77)

2. Set the format for the video to be recorded.

- “Setting the format for the video to be recorded” (page 125)

3. Click [Live] on the Web screen and then click [Other Menu >>].

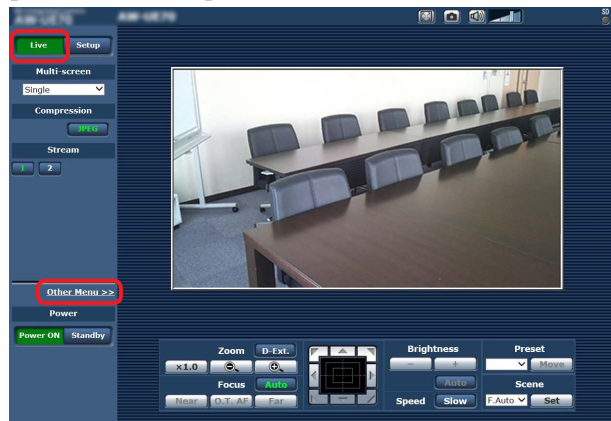

Recording to and playing back from a memory card (continued)

4. Start and stop recording by clicking the [Rec] button and [Stop] button of the “SD Card Operation” item.

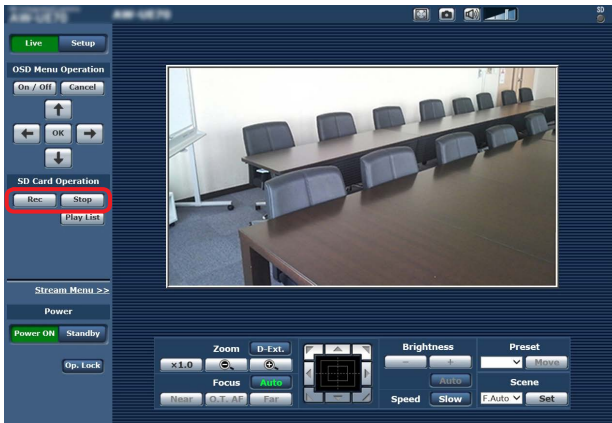

- When recording starts, the SD access lamp on the top right of the screen is displayed in red.
- When the SD access lamp is displayed red, recording is not possible because the SD card is being accessed.
- If you set “Record tally” to “On”, the tally lamp will be lit during recording. (“Record tally” on page 79)
- Recording is performed from the starting to stopping of shooting. However, the maximum recording duration is up to 8 hours. If recording exceeds 8 hours, the unit pauses recording and then resumes recording automatically.
- The minimum recording duration is approximately 2.5 seconds.
- The following operations are not possible during recording.
 - Menu operation on the web screen
 - Display of the OSD menu
 - Switching of shooting mode (Scene)
 - Switching to web setup screen [Setup]

- If the web screen is updated during recording, display becomes the Other menu of the Live screen.
- When the unit records to a microSDHC memory card, it usually splits the recording into 4 GB files. However, if the bit rate in the “Recording format” item is set to a small value, the file will be split even when recording continues for a 30-minute period or 120-minute period. The file will also be split if its size reaches 48 GB.
- The maximum number of video files that can be recorded to one SD card is approximately 89100. Also, the maximum number of folders is approximately 900.

Setting the format for the video to be recorded

Set the size, frame rate, and bit rate of the video to be recorded to an SD card.



1. Select the size, frame rate, and bit rate from the pull-down list in the “Recording format” item.
 - “SD card tab [SD memory card]” (page 79)

Guide to recording modes and recording durations

Recording format / Bit rate			SD card capacity / Recording duration		
System frequency 59.94 Hz	System frequency 50 Hz	Bit rate	4 GB	16 GB	64 GB
1920x1080/59.94p	1920x1080/50p	Up to 28 Mbps	Approx. 19 minutes	Approx. 1 hour 20 minutes	Approx. 5 hours 20 minutes
1920x1080/29.97p	1920x1080/25p	Average 15 Mbps	Approx. 30 minutes	Approx. 2 hours	Approx. 9 hours
		Average 10 Mbps	Approx. 45 minutes	Approx. 3 hours	Approx. 13 hours 30 minutes
		Average 6 Mbps	Approx. 1 hour 15 minutes	Approx. 5 hours 30 minutes	Approx. 23 hours
1280x720/59.94p	1280x720/50p	Average 15 Mbps	Approx. 30 minutes	Approx. 2 hours	Approx. 9 hours
1280x720/29.97p	1280x720/25p	Average 8 Mbps	Approx. 1 hour	Approx. 4 hours	Approx. 17 hours 30 minutes
		Average 4 Mbps	Approx. 2 hours	Approx. 8 hours 30 minutes	Approx. 35 hours 30 minutes
		Average 2 Mbps	Approx. 4 hours	Approx. 17 hours 30 minutes	Approx. 72 hours
		Average 1 Mbps	Approx. 8 hours 30 minutes	Approx. 35 hours 30 minutes	Approx. 145 hours

- The above durations are estimates for the length of time that continuous recording is possible.
- When a subject that moves a lot is recorded, the possible recording duration may become shorter.
- When the recording of short scenes is repeated, the possible recording duration may become shorter.

Recording to and playing back from a memory card (continued)

Playing Back



1. Click the [Play List] button of the “SD Card Operation” item.

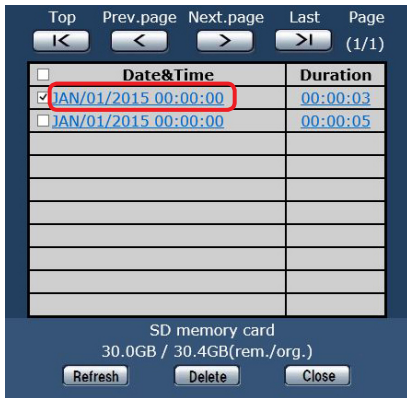

- The Play List screen displays content in the order in which recording started.

2. Click the content to play from the list of recorded content.

Play List screen

Select content individually.

Select all content.

Switches to top page.

Returns to the previous page.

Goes to the next page.

Switches to last page.

Displays the number of pages.

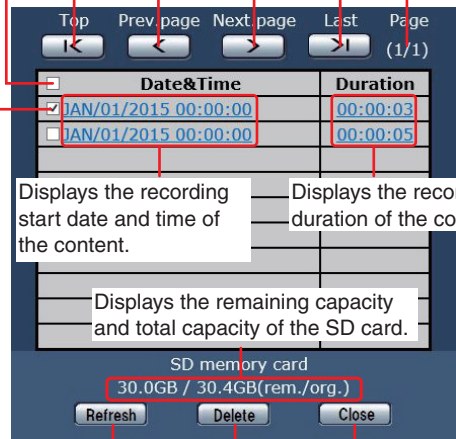

Acquires the latest information.

Deletes the selected content.

Close the Play List screen.

Recording to and playing back from a memory card (continued)

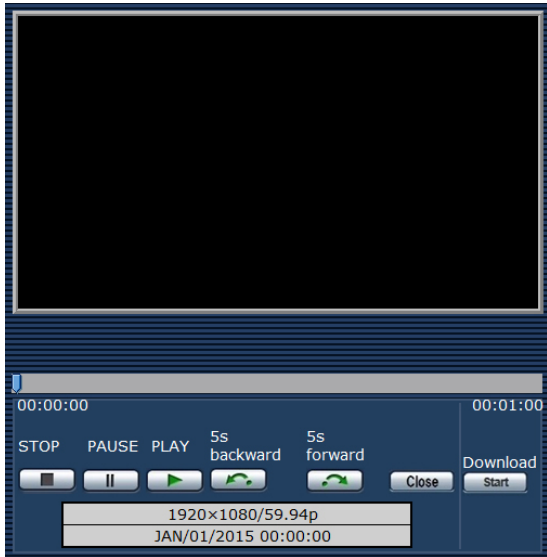

3. Perform playback operations with the buttons on the playback screen.

	Stops playback.
	Pauses playback.
	Starts playback.
	Rewinds the content by 5 seconds.
	Fast forwards the content by 5 seconds.
	Stops playback and closes the playback screen.

You can move the slider to play back the content from any position. When playback reaches the end, the slider returns to the beginning and the screen becomes a black image.

- The recording format and the recording start date and time of the content currently playing back are displayed below the operation buttons.

Notes

- The recorded video is played back but the audio is not played back.
- The recorded video can be played back on the Web screen but video cannot be output through the monitor output.
- If is clicked to close the playback screen or Play List screen, operation of the "SD Card Operation" item may become not possible for a while. When closing a screen, click .

Note

- Playback is not possible while the SD access lamp is lit (such as when files are being downloaded).

Downloading a file

Download

Click this button on the playback screen to download the file currently playing back to the connected personal computer. Specify the save destination on the personal computer.

- If downloading does not start and no operation is performed for a while, downloading may not be possible. If the file could not be downloaded, click again to start downloading.

Notes

- Start the saving of the file soon after clicking .
- Downloaded MP4 files are designed for playback on ordinary personal computers and other devices. If playback is interrupted or the video is distorted, check "Required personal computer environment" (page 11) or update the graphic driver and other software to the latest versions.
- If any of the following operations is performed, the playback or download operation stops.
 - Switching to standby state
 - Restarting
 - Switching of priority mode (from "SD card" to another mode)
 - Ejecting of SD card
 - Clicking of or

Checking the remaining capacity of an SD card

You can check the remaining capacity of an SD card in the Play List screen.

For details, refer to "Play List screen" (page 126).

Alternatively, you can check the remaining capacity in "Remaining capacity" on the Web screen.

For details, refer to "Remaining capacity" (page 79).

Formatting (initializing) an SD card

For details, refer to "Format" in "SD card tab [SD memory card]" (page 79).

Web camera functions

The unit can be used as a Web camera if you connect the unit and a personal computer or other device with a commercially available USB cable.

The unit is compliant with USB Video Class and USB Audio Class. The video and audio of the unit can be transmitted to a personal computer or other device by using communication software or other software.

- Set the priority mode to “USB” before use. (page 77)
- For the connection procedure, refer to the Installation Instructions → “Connections” → “System example 7 (USB connection, Web camera)”.
- Audio can be output from the audio input connector [AUDIO IN] of the unit to a personal computer or other device.

Notes

- There is no guarantee that operation will be possible with all devices that have a USB port.
- IP control, IP video transmission, and PoE+ power supply can be used at the same time as these functions if you use a LAN cable. However, some limitations will occur to IP video transmission compared with when the priority mode is set to “IP”. For details, refer to “Priority mode (Priority Mode)” (page 30, page 56, page 77, page 130).
- The high dynamic range (HDR) function cannot be used.

■ Controllable functions

The following functions can be controlled when the unit is used as a Web camera.

- The names of the functions are the names used in Windows. Furthermore, values are shown as decimals.
- [] indicates the actual function names.

Image adjustment [Video Proc Amp]

Brightness [Brightness]

This can be set in the same way as “Contrast Level” of the camera menus and Web settings.

Setting range: -10 to +10

- This cannot be controlled when the lens iris is set to manual adjustment.

Contrast [Contrast]

This is not supported by this unit.

Hue [Hue]

This is not supported by this unit.

Saturation [Saturation]

This allows you to set a function equivalent to “Chroma Level” of the camera menus and Web settings.

Setting range: 0 to 6

- Equivalent to -3 to +3 of “Chroma Level”.
- If the shooting mode (scene) is set to “Full Auto”, even if this setting is changed, the change will not be reflected on the unit.

Sharpness [Sharpness]

This is not supported by this unit.

Gamma [Gamma]

This is not supported by this unit.

White balance [White Balance]

This allows you to set a function equivalent to “White Balance Mode” and “Color Temperature” of the camera menus and Web settings.

- If this item is set to auto mode, “White Balance Mode” can be set as “ATW”. Also, if auto mode is canceled, “White Balance Mode” is set as “VAR”.
- When this is set to VAR, you can set the color temperature from 2400K to 9900K.
- If this item is set to auto mode, the color temperature cannot be controlled.
- A white balance mode other than ATW or VAR cannot be set. Use the camera menus or Web settings of the unit.
- If the unit is connected with a USB connection when the white balance mode is other than ATW or VAR, a white balance mode other than ATW or VAR will be retained unless the auto mode setting is changed.

Backlight compensation [Backlight Comp]

This allows you to set backlight compensation in the same way as “Back Light COMP.” of the camera menus and Web settings.

Setting value: 0 (Off), 1 (On)

- It is enabled when any of Contrast Mode, Gain, and Frame Mix is “Auto”.
- If the shooting mode (scene) is set to “Full Auto”, even if this setting is changed, the change will not be reflected on the unit.
- When Day/Night is set to “Auto”, this is set to “Off”.

Gain [Gain]

This allows you to set gain adjustment in the same way as “Gain” of the camera menus and Web settings.

Setting range: 0 to 17

- Equivalent to Auto, 0dB, 3dB, and 6dB to 48dB.
- If the shooting mode (scene) is set to “Full Auto”, even if this setting is changed, the change will not be reflected on the unit.

Use of color [Color Enable]

This is not supported by this unit.

Power line frequency (Anti flicker) [Power Line Frequency (Anti Flicker)]

This is not supported by this unit.

Web camera functions (continued)

Camera control [Camera Control]

Zoom [Zoom]

This allows you to enlarge (zoom in) and reduce (zoom out) images.

Setting range: 1 (wide end) to 2731 (optical telephoto end)

Focus [Focus]

The lens focus can be adjusted manually.

Setting range: 1 (Near) to 2731 (Far)

- This cannot be controlled when the focus mode is "Auto".
- If this item is set to auto mode, the focus mode is set as "Auto". Also, if auto mode is canceled, the focus mode is set as "Manual".

Exposure [Exposure]

This allows you to set the shutter speed in the same way as when "Step" is selected in the "Shutter Mode" item of the camera menus and Web settings.

Setting value:

	[When 59.94 Hz has been set as the unit's frequency]	[When 50 Hz has been set as the unit's frequency]
-13	1/10000	1/10000
-12	1/4000	1/4000
-11	1/2000	1/2000
-10	1/1000	1/1000
-9	1/500	1/500
-8	1/250	1/250
-7	1/100	1/120
-6	Off	Off

- If this item is set to auto mode, the lens iris is set to automatic adjustment and "Contrast Mode" of the camera menus and Web settings is set to "Auto". If auto mode is canceled, the lens iris is set to manual adjustment and "Contrast Mode" of the camera menus and Web settings is set to "Manual".
- This cannot be controlled when the lens iris is set to automatic adjustment.
- If the shooting mode (scene) is set to "Full Auto", even if this setting is changed, the change will not be reflected on the unit.
- The settings of the auto mode of [Exposure] and [Aperture (Iris)] are linked. The settings are in accordance with the auto mode set last.

Aperture (Iris) [Aperture (Iris)]

The lens iris can be adjusted manually.

Setting range: 1 (minimum) to 2731 (open)

- If this item is set to auto mode, the lens iris is set to automatic adjustment and "Contrast Mode" of the camera menus and Web settings is set to "Auto". If auto mode is canceled, the lens iris is set to manual adjustment and "Contrast Mode" of the camera menus and Web settings is set to "Manual".
- This cannot be controlled when the lens iris is set to automatic adjustment.
- The setting may be configured with a value that is ten times larger depending on the communication software used.
- If the shooting mode (scene) is set to "Full Auto", even if this setting is changed, the change will not be reflected on the unit.
- The settings of the auto mode of [Exposure] and [Aperture (Iris)] are linked. The settings are in accordance with the auto mode set last.

Pan [Pan]

The camera can be panned left or right.

Setting range: -175 to +175 (1° increments)

- The movement speed can be changed in "Preset Speed Table"/"Preset Speed" of the camera menus and Web settings.

Notes

- After connecting via USB, do not change "Install Position". Operation will be in the opposite direction.
- The default setting may be possible but panning of the unit may not be able to be controlled depending on the communication software.

Tilt [Tilt]

The camera can be tilted up or down.

Setting range: -30 to +90 (1° increments)

- The movement speed can be changed in "Preset Speed Table"/"Preset Speed" of the camera menus and Web settings.

Note

- After connecting via USB, do not change "Install Position". Operation will be in the opposite direction.

Roll [Roll]

This is not supported by this unit.

Low light compensation [Low Light Compensation]

This is not supported by this unit.

Web camera functions (continued)

Audio input mixer [Audio Input Mixer Properties]

Enable/Disable (Mute) [Enable]

The audio input signal from the device connected to the audio input connector can be turned off or on in the same way as “Audio” of the camera menus and Web settings.

Setting value: 0 (Off), 1 (On)

Volume

Set the microphone input, line input, and volume in the same way as with “Input Volume” of camera menus and Web settings.

Setting range: 0 to 1535

- The relationship to “Input Volume” of the camera menus and Web settings is as follows.

1535 to 1280	Mic High
1279 to 1024	Mic Middle
1023 to 768	Mic Low
767 to 512	Line High
511 to 256	Line Middle
255 to 0	Line Low

Notes

- The volume may be adjusted automatically depending on the communication software used. Audio may not be stable depending on the combination of the unit and communication software. Set “USB Vol. Control” to “Disable” if this is the case. (page 66, page 87)
- Video and audio may not be stable depending on the performance of your personal computer or other device. In this case, reduce the resolution and frame rate of the video or input the audio not from the unit but from the personal computer or other device.

Notes

- When the priority mode is “USB”, the IP transmission of H.264 images is not possible.
- When the device is connected by USB, the IP video JPEG(1) setting is forcefully changed to 320×180/5fps.

Displaying the web screen using a mobile terminal

Connect the mobile terminal to the unit, and display the unit's images (JPEG format only). Refreshing to the latest images takes place automatically.

Operations such as panning, tilting and zooming can also be performed from the mobile terminal.

The following models are supported as mobile terminals. (as of May 2015).

Mobile terminal	Specifications
iPad iPhone iPod touch	iOS 8.3
Android™ terminals	Android 4.4

Notes

- For the latest information on compatible operating systems and web browsers, visit the support desk at the following website.
<https://pro-av.panasonic.net/>
- Use a standard web browser with an Android terminal.
- Images are displayed only in the JPEG format when using the mobile terminal.
- When the authentication dialog box is displayed, input the user name and password.
The default settings for the user name and password are as follows.

User name	admin
Password	12345
- If the mobile terminal does not support the character code UTF-8, the characters cannot be displayed properly.



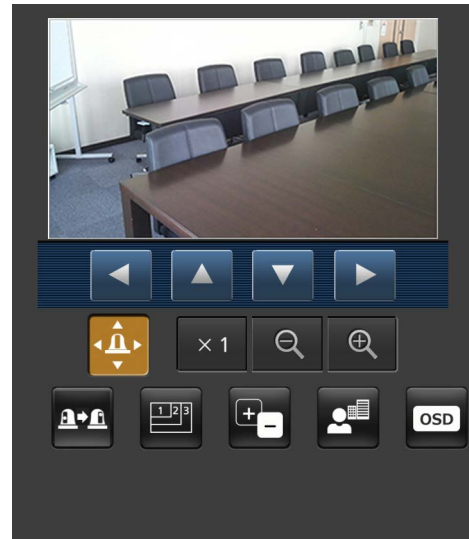

1. Input "http://IP address/mobile/" using the mobile terminal, and press the enter button.

The unit's images will now be displayed.

Pan/Tilt



When this button is pressed, the buttons for performing the pan/tilt operations are displayed on the screen.



	The camera is panned toward the left.
	The camera is tilted upward.
	The camera is tilted downward.
	The camera is panned toward the right.

Note

- The camera will not move diagonally even when the pan and tilt buttons are pressed at the same time. (The button pressed first takes precedence.)

Zoom

The unit's zooming operations are performed using these buttons.



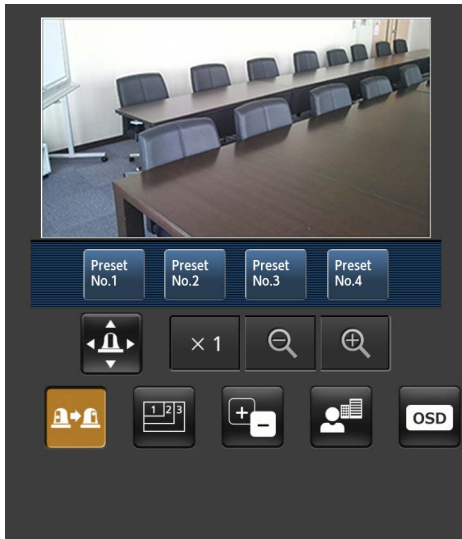

	Use this to adjust the zoom (magnification) to 1.0x.
	Use this to adjust the zoom (magnification) in the Wide direction.
	Use this to adjust the zoom (magnification) in the Tele direction.

Displaying the web screen using a mobile terminal (continued)

Preset



When this button is pressed, the buttons for selecting the preset positions are displayed on the screen.



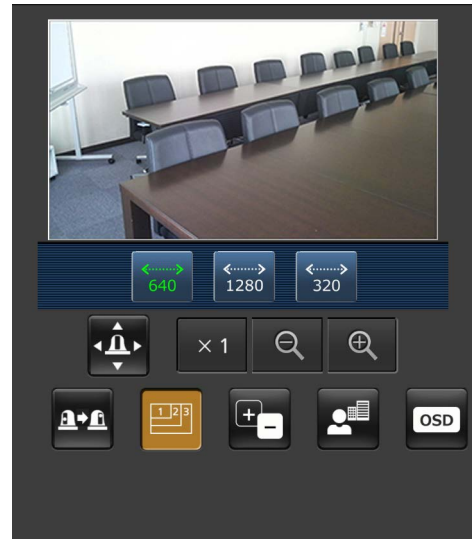

	
	When one of the displayed buttons is pressed, the camera's pan/tilt position moves to the preset position that was registered ahead of time.
	The settings that are reproduced at this position are the settings which were established on the [Preset Scope] menu (page 58, page 95, page 97).
	

Resolution switching



When this button is pressed, the buttons for selecting the resolution are displayed on the screen.

The characters are displayed in green for the resolution button which is currently selected. The resolution configured with [JPEG(1)], [JPEG(2)], and [JPEG(3)] in the [Video over IP] tab is displayed.

	The images are displayed with a resolution of 1920 × 1080 pixels.
	The images are displayed with a resolution of 1280 × 720 pixels.
	The images are displayed with a resolution of 640 × 360 pixels.
	The images are displayed with a resolution of 320 × 180 pixels.

Note



- Depending on the resolution set for [JPEG(1)], [JPEG(2)], and [JPEG(3)], resolution switching may not be possible.

Displaying the web screen using a mobile terminal (continued)

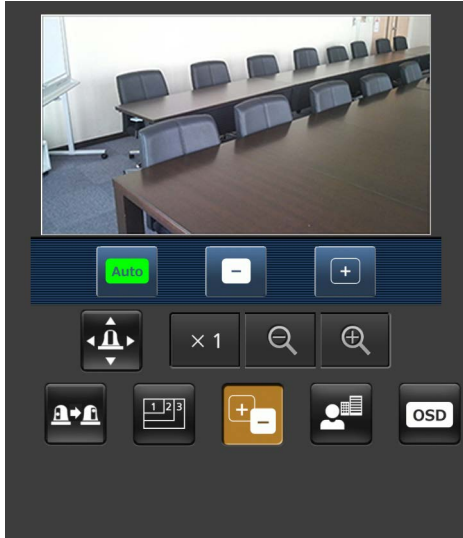
Iris





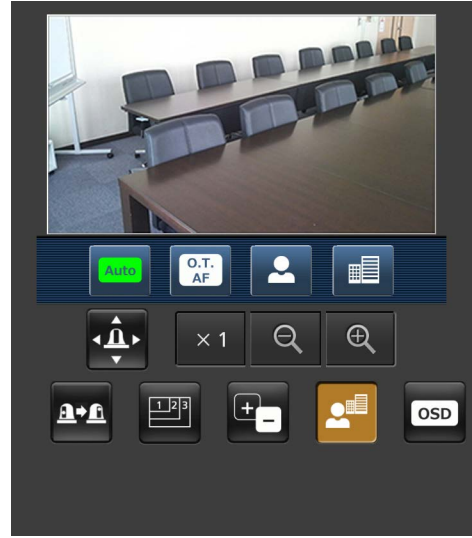

When this button is pressed, the buttons for performing the iris operations are displayed on the screen.

	This switches the iris between auto and manual. At the auto setting, the button label is green.
	This adjusts the iris in the “close” direction. It does not work during automatic adjustments.
	This adjusts the iris in the “open” direction. It does not work during automatic adjustments.

Focus



When this button is pressed, the buttons for performing the focusing operations are displayed on the screen.

	Use this to switch between auto and manual focusing. At the auto setting, focusing is performed (the focal point is adjusted) automatically. At the auto setting, the button label turns green.
	When this is pressed while the focus is being adjusted manually, the focus will be temporarily adjusted automatically. It does not work during automatic adjustments.
	Use this to adjust the focus in the Near direction. It does not work during automatic adjustments.
	Use this to adjust the focus in the Far direction. It does not work during automatic adjustments.

Displaying the web screen using a mobile terminal (continued)

Camera menu (OSD menu) operation OSD

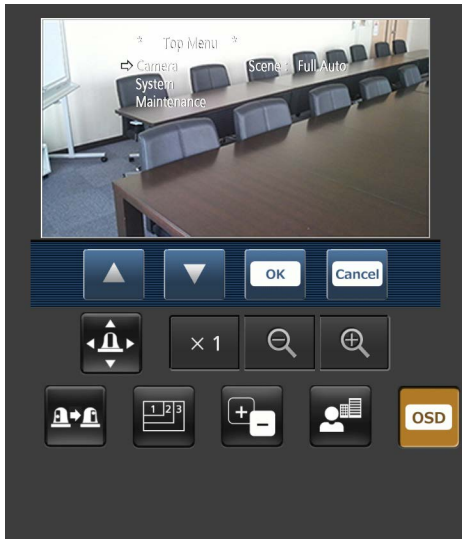

When this button is pressed, the buttons for performing the camera menu operations are displayed on the screen. At the same time, the camera menus are also displayed on the monitor images of the unit.

	<p>The unit's camera menu operations can be performed by pressing the , , , and buttons.</p> <p>When any of these buttons is pressed to switch to an operation that does not involve a camera menu, the camera menus are no longer displayed on the unit's images.</p> <p>For details of the camera menu, refer to page 64.</p>

Tally lamp lighting status displays

The lighting status of the camera's tally lamp is monitored at regular intervals while the camera is connected, and the lamp's display is updated.

While the tally lamp is on, the IP video display area frame turns red.

When the tally lamp is off, the display area will return to normal.

Notes

- It may take 2 seconds or so for a change in the lighting status of the tally lamp to be reflected on the display of the mobile terminal.
- When [Disable] is selected for [Tally] (page 59, page 99), the camera's tally lamp will not light even when the tally signal is input. However, the tally lamp lighting status display will turn red.

Notes

- If the HTTP port number has been changed from "80", enter "http://<IP address>:<port number>/mobile/" to specify the unit's port number.
- When the authentication dialog box appears, enter the user name and password of an administrator or general user.
Depending on the mobile terminal, password entry may be required when transitioning between each screen.
- Audio cannot be received on mobile terminals.
- If the [User auth.] (page 101) setting has been changed to [On] from a personal computer while the mobile terminal screen is displayed, it may not be possible to refresh the mobile terminal screen. In a case like this, first close the web browser which is running on the mobile terminal, and then open the mobile terminal screen again.
- If, when using an Android terminal, more than one button is pressed at the same time, one of the buttons may remain pressed even after it has been released. At a time like this, press again only that button that has remained pressed to release it.
Example) When the pan (left) button and pan (right) button are pressed at the same time, either the pan (left) button or pan (right) button will remain pressed, and panning will continue.
→ When the pan (left) button or pan (right) button that has remained pressed is pressed again, the panning will stop.

Operations for recording to an SD card



Perform the operations for recording the video and audio captured with the unit to an SD card.

These buttons are displayed at the bottom of the screen only when the priority mode (page 56, page 77) is set to "SD card".

	<p>Starts recording to an SD card.</p> <p>When this operation is performed, ●REC is displayed.</p>
	<p>Stops recording to an SD card.</p> <p>When this operation is performed, ●REC disappears.</p>

Limiters

The unit comes with settings (referred to as “limiters”) that restrict the panning and tilting movement ranges.

Depending on where the unit has been installed, a subject which the user does not wish to be shot may be present in the movement ranges.

In a case like this, the unit’s shooting range can be limited by setting the limiters at the positions just before the subject which the user does not wish to be shot.

The positions of four limiters — namely, the upper, lower, left-most and right-most limits of the travel range — can be set. Once they have been set, the positions will not be lost even after the power has been turned off.

The limiters can be set or released both by the wireless remote control and controller or web setting screen. Whatever was set or released last takes precedence. For the controller operations, refer to the Operating Instructions of the controller.

The settings of the limiters using the wireless remote control will be described here.

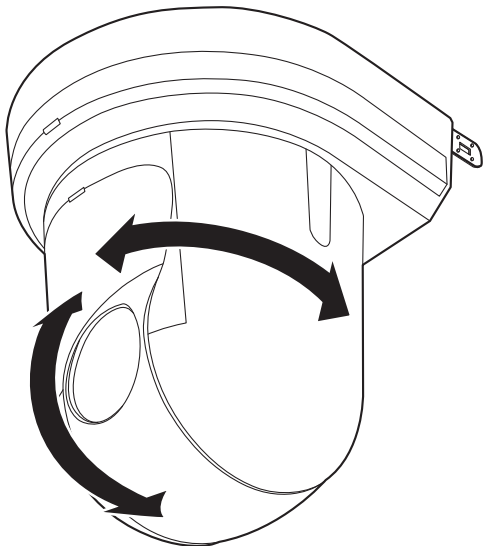

■ Basic limiter operations

1 Press the [MENU] button.

Tap the button (rather than pressing it).

When it is pressed for 2 seconds, the camera menu will appear.

If this happens, press the [MENU] button again for 2 seconds to clear the camera menu.

Then start again from step 1.

2 Press the [▲], [▼], [◀] or [▶] button for 2 seconds while holding down the [PRESET] button.

The limiter for the upper limit, lower limit, left limit or right limit is set (or released) using these direction buttons, respectively.

The tally lamp will blink at this time.

When a limiter is set, it blinks once; when a limiter is released, it blinks twice.

If any other button was operated between steps 1 and 2, start again from step 1.

Limiters (continued)

■ Setting the limiters

The limiter positions can be set by following the steps below. When the position is set, the tally lamp blinks once.

1 Press one of the [CAM1] to [CAM4] buttons to select the unit.

- **Setting the upper limit position of the movement range**
Press the [▲] or [▼] button of the wireless remote control to turn the unit as far as the position which will serve as the upper limit.
Next, perform the steps in “Basic limiter operations”. (Press the [MENU] button quickly and then press the [▲] button for 2 seconds while holding down the [PRESET] button.)
- **Setting the lower limit position of the movement range**
Press the [▲] or [▼] button of the wireless remote control to turn the unit as far as the position which will serve as the lower limit.
Next, perform the steps in “Basic limiter operations”. (Press the [MENU] button quickly and then press the [▼] button for 2 seconds while holding down the [PRESET] button.)
- **Setting the left-most limit position of the movement range**
Press the [◀] or [▶] button of the wireless remote control to turn the unit as far as the position which will serve as the left-most limit.
Next, perform the steps in “Basic limiter operations”. (Press the [MENU] button quickly and then press the [◀] button for 2 seconds while holding down the [PRESET] button.)
- **Setting the right-most limit position of the movement range**
Press the [◀] or [▶] button of the wireless remote control to turn the unit as far as the position which will serve as the right-most limit.
Next, perform the steps in “Basic limiter operations”. (Press the [MENU] button quickly and then press the [▶] button for 2 seconds while holding down the [PRESET] button.)

■ Releasing the limiters

The limiter positions that are set can be released by following the steps below.

When the position is released, the tally lamp blinks twice.

1 Press one of the [CAM1] to [CAM4] buttons to select the unit.

2 Release the limiters by taking the steps below.

- **Releasing the upper limit position of the movement range**
Perform the steps in “Basic limiter operations”. (Press the [MENU] button quickly and then press the [▲] button for 2 seconds while holding down the [PRESET] button.)
- **Releasing the lower limit position of the movement range**
Perform the steps in “Basic limiter operations”. (Press the [MENU] button quickly and then press the [▼] button for 2 seconds while holding down the [PRESET] button.)
- **Releasing the left-most limit position of the movement range**
Perform the steps in “Basic limiter operations”. (Press the [MENU] button quickly and then press the [◀] button for 2 seconds while holding down the [PRESET] button.)
- **Releasing the right-most limit position of the movement range**
Perform the steps in “Basic limiter operations”. (Press the [MENU] button quickly and then press the [▶] button for 2 seconds while holding down the [PRESET] button.)

■ Resetting the limiters

To reset the limiters, the currently established settings must be released.

The limiter positions that are set can be reset by following the steps below.

1 Release the settings of the limiter positions to be reset by following the steps in “Releasing the limiters”.

2 Set the limiter positions by following the steps in “Setting the limiters”.

Activation

This function is for future expansion of the unit's functionality. Activation can be performed by purchasing "Feature Upgrade" (paid upgrade).

Perform activation as described below.

1. **Checking whether activation has been performed**

↓

2. **Obtaining the activation code**

↓

3. **Activating the unit**

↓

4. **Checking that activation is complete**

Checking whether activation has been performed

1. Click [Setup] → [Maintenance] → [Product info.] from the Web screen.

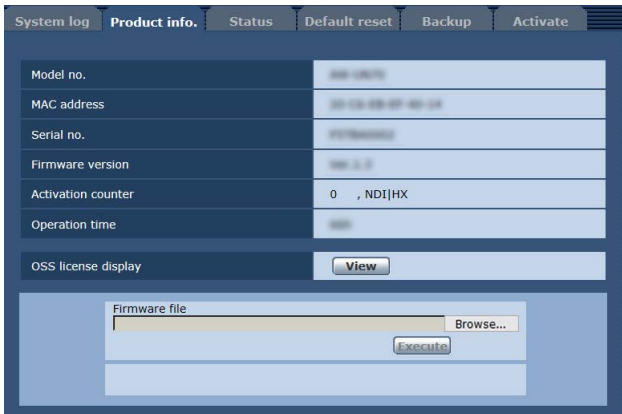

2. Check the value of the "Activation counter" item.

0	Activation has not been performed. (Initial setting state)
1 or higher	Activation has been performed.

Obtaining the activation code

The activation code can be obtained by accessing the activation code generation site and then having the serial number information of the unit and key code included with "Feature Upgrade" authenticated.

1. Click [Setup] → [Maintenance] → [Activate] from the Web screen.

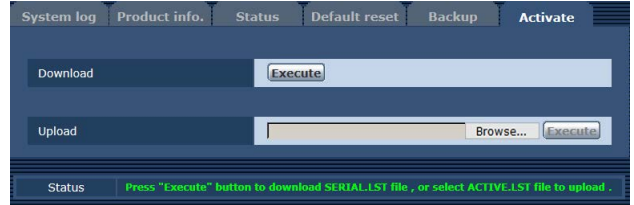

2. Click the [Execute] button of the "Download" item.
3. Click the [OK] button.
"SERIAL.LST" (serial number information file of the unit) is downloaded to the personal computer.
4. Connect to the following activation code generation site from the Web browser.
https://panasonic.biz/cns/sav/actkey_e/
5. Obtain the activation code following the procedure displayed on the site.
The activation code "ACTIVE.LST" is downloaded to the personal computer.
 - If multiple units are activated simultaneously, there is a risk that the "SERIAL.LST" and "ACTIVE.LST" files may be overwritten. Exercise caution in regard to storage location.

Activation (continued)

Activating the unit

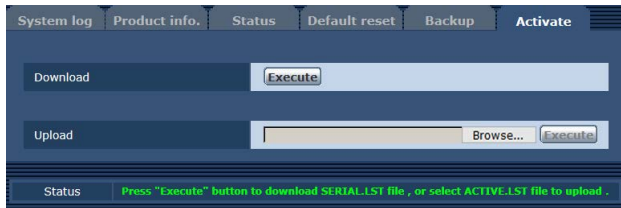

1. Click [Browse] of the “Upload” item and then specify the folder in which the obtained “ACTIVE.LST” is stored.
2. Click the [Execute] button of the “Upload” item.
3. Click the [OK] button.
After uploading completes, the unit restarts automatically.
4. Click the [OK] button.
The web screen appears.
5. Close the Web browser once.

Checking that activation is complete

1. Click [Setup] → [Maintenance] → [Product info.] from the Web screen.

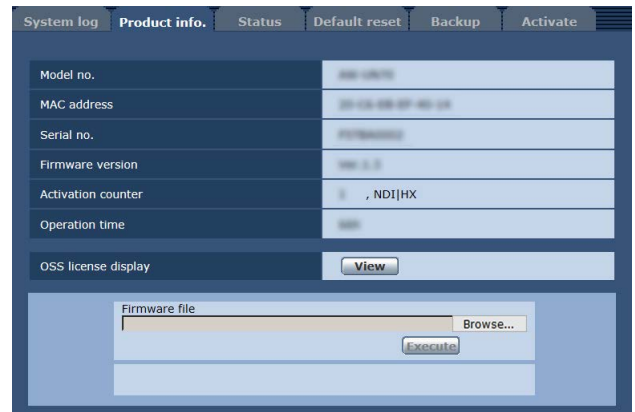

2. Check the value of the “Activation counter” item.
Check that the value has been incremented in accordance with the activation file.

Troubleshooting

● Operation

Symptom	Cause and remedial action	Reference pages
No power	<ul style="list-style-type: none"> Is the AC adaptor securely connected to the AC outlet? 	—
	<ul style="list-style-type: none"> Is the power plug of the AC adaptor connected properly? 	—
	<ul style="list-style-type: none"> Is the network cable for the PoE+ (IEEE802.3at compliant) compatible power supply device and the unit connected properly? 	Installation Instructions → “Connections” → “System example 6 (IP image transmission, PoE+)”
	<ul style="list-style-type: none"> Power may not be supplied if the total power limit is exceeded on power supply devices that allow connections to multiple PoE+ terminals. → Refer to the operating instructions for the PoE+ power supply device. 	—
The status display lamp flashes red continuously	<ul style="list-style-type: none"> The PoE+ power supply conditions do not meet the specifications. → Check the power supply device. 	P.14
The status display lamp flashes red several times	<ul style="list-style-type: none"> An error such as an attempt to perform a recording operation while an SD card is not inserted has occurred. → Check the event log. 	P.119
Cannot operate (common to wireless remote control, controller)	<ul style="list-style-type: none"> Is the power on? → If the unit’s status display lamp is off or if it has lit up orange, it means that the unit’s power is not being supplied. 	P.29
	<ul style="list-style-type: none"> Have the limiter functions been set? 	P.135 to 136
	<ul style="list-style-type: none"> Has the correct unit to be operated been selected? 	P.31

Troubleshooting (continued)

Symptom	Cause and remedial action	Reference pages
Cannot operate using the wireless remote control	<ul style="list-style-type: none"> • Have the remote control's batteries run down or have the batteries been installed with their polarities reversed? → If the status display lamp does not blink even when the wireless remote control is operated near the wireless remote control signal light-sensing area, it means that the batteries have run down. Replace the batteries. 	—
	<ul style="list-style-type: none"> • Has the IR ID setting been set correctly? 	P.60, P.99
	<ul style="list-style-type: none"> • Is there a fluorescent light or plasma monitor near the unit and, if so, is the wireless remote control signal light-sensing area exposed to its light? 	P.18
Cannot operate using the controller	<ul style="list-style-type: none"> • Is the unit connected to the controller properly? → Refer to the Operating Instructions of the controller. 	Installation Instructions → "Connections" → "Connecting a controller (AW-RP50) (IP connection example)" to "System example 5 (infrared output connection)"
	<ul style="list-style-type: none"> • Are all the cameras in the daisy-chain connection turned on? 	Installation Instructions → "Connections" → "System example 1 (connection with commercially available controller, RS-232C daisy-chain connection)"
	<ul style="list-style-type: none"> • It may be necessary to upgrade the version of the controller so that the controller will support the unit. 	P.13
The unit turns in the opposite direction to the one operated	<ul style="list-style-type: none"> • Has the stand-alone (Desktop) installation setting been selected correctly? 	P.58, P.97
	<ul style="list-style-type: none"> • The reversal setting may have been established at the controller if the unit is connected to the controller. → Refer to the Operating Instructions of the controller. 	—

Troubleshooting (continued)

Symptom	Cause and remedial action	Reference pages
<p>No access is possible from the web browser</p>	<ul style="list-style-type: none"> • Has a LAN cable of category 5 or above been connected to the LAN connector for IP control? 	Installation Instructions → “Connections” → “System example 4 (IP control)”
	<ul style="list-style-type: none"> • Is the [LINK] LED of the LAN connector for IP control lit? → If it is not lit, it means that something is wrong with the connection to the LAN or that the network at the connection destination is not working properly. Check the LAN cable for defective contacts, and check the wiring. 	Installation Instructions → “Connections” → “System example 4 (IP control)”
	<ul style="list-style-type: none"> • Is the power on? → If the unit’s status display lamp is off or if it has lit up orange, it means that the unit’s power is not being supplied. 	P.29
	<ul style="list-style-type: none"> • Has a valid IP address been set in the unit? 	P.102
	<ul style="list-style-type: none"> • Has the wrong IP address been accessed? → Check the connections by following the steps below. [When using Windows] Using the Windows command prompt, execute > ping [IP address which has been set in the camera] A reply returned from the unit signifies that there are no problems in operation. If a reply is not received, try following operation: <ul style="list-style-type: none"> • Reboot the unit, and within 20 minutes change the IP address using the Easy IP Setup Software. [When using Mac] Using the OS X terminal, execute > ping -c 10 [IP address which has been set in the camera] A reply returned from the unit signifies that there are no problems in operation. If a reply is not received, try following operation: <ul style="list-style-type: none"> • Reboot the unit, and within 20 minutes change the IP address using the Easy IP Setup Software. 	—
	<ul style="list-style-type: none"> • Has 554 been set as the HTTP port number? → Use any port number, except for the numbers below which are used by the unit, for the HTTP port number. 20, 21, 23, 25, 42, 53, 67, 68, 69, 110, 123, 161, 162, 443, 554, 995, 10669, 10670, 59000 to 59999, 60000 to 61000 	P.105
	<ul style="list-style-type: none"> • Is access being performed in HTTPS mode? → For details on when [HTTPS] - [Connection] (page 110) is set to [HTTPS] in the [Advanced] tab of the [Network] screen, see “Accessing the Camera by HTTPS”. 	P.116

Troubleshooting (continued)

Symptom	Cause and remedial action	Reference pages
No access is possible from the web browser	<ul style="list-style-type: none"> • Are you accessing via “http://” while the HTTPS function is enabled? → Perform access via “https://” when using the HTTPS function. Entry of the port number is also required. 	P.116
	<ul style="list-style-type: none"> • Is the same IP address setting being used by another unit? → Check out the IP addresses of the unit, access devices (personal computer, mobile terminal, controller, etc.) and any other cameras. 	P.63, P.103
	<ul style="list-style-type: none"> • Does the subnet mask setting match the network subnet of the connection destination? → Check out the subnet mask settings of the unit and access devices, and then consult with the network administrator. 	P.63, P.103
	<ul style="list-style-type: none"> • Has the “Use a proxy server” setting been selected by the web browser? (When the unit and the personal computer are connected to the same subnet) → If a proxy server has been set using the “proxy setting” of the web browser, it is recommended that a “Don’t use proxy” address be selected as the unit’s IP address setting. 	—
	<ul style="list-style-type: none"> • Has the wrong default gateway been set for the unit? (When the unit and personal computer are connected to different subnets) → Check out the default gateway that has been set for the unit, and then consult with the network administrator. 	P.63, P.103
	<ul style="list-style-type: none"> • The network connection may be severed if the computer enters sleep mode. → After canceling the sleep mode, reload the screen as necessary. 	—
Cannot access the camera from a mobile terminal	<ul style="list-style-type: none"> • Is the URL correct? Has “/mobile” been entered at the end of the URL? → Check whether the URL has been entered correctly. When accessing the unit from a mobile terminal, “/mobile” must be added to the end of the URL used to access the unit from a personal computer. 	P.131
	<ul style="list-style-type: none"> • Is the HTTPS SSL encryption of the mobile terminal different from that of the unit? → Set [HTTPS] - [Connection] for the unit to [HTTP], and initiate access again. 	P.110

Troubleshooting (continued)

● Video/Audio

Symptom	Cause and remedial action	Reference pages
No pictures are displayed or the pictures are disturbed	<ul style="list-style-type: none"> ● Has the unit been connected properly to the other connected devices? 	Installation Instructions → "Connections"
	<ul style="list-style-type: none"> ● If the system is configured in such a way that the picture is also switched when the unit to be operated is selected, has the correct unit been selected? 	P.31
	<ul style="list-style-type: none"> ● Has the video signal setting been selected correctly? 	P.55, P.97
	<ul style="list-style-type: none"> ● Are external sync signals that are supported by the video signal format which has been set being input? 	P.21 P.54
The picture is flipped vertically	<ul style="list-style-type: none"> ● Has the stand-alone (Desktop) installation setting been selected correctly? 	P.58, P.97
Multiple color bands (color bars) are displayed	<ul style="list-style-type: none"> ● Switch to the camera picture. 	P.34
The menu screen is displayed	<ul style="list-style-type: none"> ● Exit the camera menu. 	P.44
It is difficult to view the menu screens	<ul style="list-style-type: none"> ● Depending on the HDMI monitor you are using, you may experience one or more of the symptoms described below, but these are not malfunctions. <ul style="list-style-type: none"> ● The resolution of the characters in the camera menu displays changes as the background image changes. ● Depending on the edge enhancement setting established for the monitor, white lines appear in front of the black shadows of the camera menus. ● Depending on the edge enhancement setting established for the monitor, the background colors may be superimposed onto the white parts of the camera menus. 	—
No auto focusing	<ul style="list-style-type: none"> ● Is the focus set to manual? → Auto focusing is initiated as soon as the focus is set to auto. 	P.34
	<ul style="list-style-type: none"> ● In some situations, it may be hard to focus at the auto setting. → In cases like this, select the manual setting, and focus manually. 	P.36
The subject is not brought into focus during zooming when the manual setting is used for the focus	<ul style="list-style-type: none"> ● Was the focus adjusted at the Tele end? → First adjust the focus at the Tele end where the focusing accuracy is higher, and then proceed with the zooming. 	—
	<ul style="list-style-type: none"> ● Under some operating conditions, it may be hard to bring subjects into focus. → In such cases, use the focus at the auto setting. 	P.34

Troubleshooting (continued)

Symptom	Cause and remedial action	Reference pages
No focusing in Night mode	<ul style="list-style-type: none"> ● Are you shooting in visible light? → The focusing position differs between visible light conditions and infrared conditions due to the difference in the index of refraction. It is assumed with the unit that the infrared light has a wavelength in the vicinity of 850 nm when Night mode is used. Focus manually as required. 	P.36
The images appear jerky when the 1080/29.97PsF or 1080/25PsF format is selected	<ul style="list-style-type: none"> ● Operation is problem-free. → What happens with the PsF (progressive segmented frame) system is that the same images as the progressive system are output by recording the same images in field 1 and field 2 so that the resulting images may appear somewhat jerky. 	—
Something is wrong with the coloring of the pictures	<ul style="list-style-type: none"> ● Activate the ATW (Auto tracking white adjustment) function. 	P.41
	<ul style="list-style-type: none"> ● In some situations, the proper colors may not be reproduced using the ATW function. → In cases like this, proceed with the white balance adjustment. 	P.39 to 42
The pictures are too light or too dark	<ul style="list-style-type: none"> ● Use the ND filters to adjust light intensity. 	P.46, P.90
	<ul style="list-style-type: none"> ● Either select the auto setting for the iris or select the manual setting and adjust the iris manually. 	P.36
	<ul style="list-style-type: none"> ● Set “Auto Shutter Limit” to “Off”. 	P.47, P.89
The images are in black and white	<ul style="list-style-type: none"> ● Is Night mode established? → In Night mode, the images are output in black and white. 	P.46, P.49, P.90
The auto white balance adjustment (AWB) does not work	<ul style="list-style-type: none"> ● Is Night mode established? → The auto white balance adjustment (AWB) cannot be used in Night mode. 	P.39 to 41, P.46, P.49, P.90
	<ul style="list-style-type: none"> ● Is the scene mode set to [Full Auto]? → ATW is performed in Full Auto mode. 	P.31
The screen is excessively bright in Night mode	<ul style="list-style-type: none"> ● In Night mode, the iris is set to open as a measure to prevent video spying. Adjust the brightness at the light source. 	P.46, P.49, P.90
The iris cannot be operated in Night mode		
The subjects appear distorted	<ul style="list-style-type: none"> ● Since this camera uses a MOS image device, the shooting timing differs slightly at the top left and bottom right of the screen. This means that if a subject has moved quickly across in front of the camera, it may appear slightly distorted. This is not a malfunction. 	—
When the flash is fired during shooting, only the top or bottom of the screen becomes lighter	<ul style="list-style-type: none"> ● With a MOS image sensor, the shooting timing differs slightly between the top left and bottom right of the screen. This means that when the flash is fired, the bottom of the screen will become lighter in the field concerned and the top will become lighter in the next field. This is not a malfunction. 	—

Troubleshooting (continued)

Symptom	Cause and remedial action	Reference pages
The brightness changes cyclically or the colors change, and horizontal stripes can be seen passing across the screen	<ul style="list-style-type: none"> • These phenomena (flicker) may occur under the illumination produced by fluorescent lighting, mercury bulbs or other types of discharge tubes. In cases like this, it is recommended that the electronic shutter speed be set as follows. <p>When the Frequency is set to “59.94Hz”</p> <ul style="list-style-type: none"> • Set to 1/100 in areas where the power line frequency is 50 Hz. • Set the electronic shutter to OFF in areas where the power line frequency is 60 Hz. <p>When the Frequency is set to “50Hz”</p> <ul style="list-style-type: none"> • Set to 1/120 in areas where the power line frequency is 60 Hz. • Set the electronic shutter to OFF in areas where the power line frequency is 50 Hz. <p>This can also be resolved by setting the shutter mode to [Synchro] and adjusting the shutter value.</p>	—
When fine lines or cyclical patterns are shot, flickering is seen or coloring is added to them	<ul style="list-style-type: none"> • This phenomenon occurs because the pixels are arranged systematically on each image sensor. It is noticeable when the spatial frequency of a subject and the pixel pitch are brought into proximity so change the camera angle or take other such action. • When the high dynamic range function (HDR) is enabled, flickering may be noticeable depending on the subject. This is not a malfunction. If necessary, disable the HDR function. 	—
Noise occurs in the audio input	<ul style="list-style-type: none"> • Are the camera, switching hub, or other peripheral devices grounded? • Are power lines are running nearby? • Is equipment generating strong electric or magnetic fields (e.g., television and radio antennas, air conditioning compressors, power transformers) located nearby? <p>→ If the noise is not reduced via movement of surrounding devices, use a microphone equipped with an amplifier, or connect an audio output with low output impedance.</p>	—
Tally lamp fails to light	<ul style="list-style-type: none"> • Has “Disable” been selected for “Tally”? <p>→ When “Disable” is selected for “Tally”, the camera’s tally lamp will be off. Change the setting to “Enable”.</p>	P.59, P.99
	<ul style="list-style-type: none"> • Has “Off” been selected for “Record tally”? <p>→ When “Off” is selected for “Record tally”, the unit’s tally lamp does not light during recording to an SD card. Change the “Record tally” setting to “On”.</p>	P.79

Troubleshooting (continued)

● IP videos

Symptom	Cause and remedial action	Reference pages
No images are displayed	<p>[When using Windows]</p> <ul style="list-style-type: none"> • Is the plug-in viewer software installed? → Install the plug-in viewer software. 	P.26
	<p>[When using Windows]</p> <ul style="list-style-type: none"> • If “Every time I visit the webpage” is not selected for “Check for newer versions of stored pages” in the Temporary Internet Files settings, the IP videos on the Live screen may not be displayed properly. → Follow the steps below. <ol style="list-style-type: none"> ① In Internet Explorer, select [Tools] → [Internet Options]. ② Click the [General] tab, and click the [Settings] button in “Browsing history”. ③ In the [Temporary Internet Files and History Settings] dialog box, under “Check for newer versions of stored pages”, set the radio button ON for [Every time I visit the webpage]. ④ Click the [OK] button. 	—
[H.264] cannot be selected	<ul style="list-style-type: none"> • [H.264] cannot be selected when the Priority Mode selection is anything other than “IP”. Only JPEG images can be displayed on the Live screen. 	P.30, P.56, P.77
The images are not refreshed	<ul style="list-style-type: none"> • The images may not be refreshed or other trouble may occur with some web browsers or their version which is being used. 	—
	<ul style="list-style-type: none"> • Image display may be suspended if the network is congested or the unit is being accessed excessively. • When the IP video settings of the unit have been changed, the display of the images may be suspended temporarily. → Check the status of access to the unit, and stop any access which can be suspended. Then take one of the following steps. <p>[When using Windows] Press the [F5] key on the keyboard of the personal computer to request that the settings be acquired.</p> <p>[When using Mac] Press the [Command] + [R] keys on the keyboard of the personal computer to request that the settings be acquired.</p> <p>[When using a mobile terminal] Refresh the screen by, for instance, pressing the [Refresh] button of the web browser to request that the settings be acquired.</p> 	—

Troubleshooting (continued)

Symptom	Cause and remedial action	Reference pages
<p>The settings on the web setting screen are not updated or displayed properly</p>	<p>[When using Windows]</p> <ul style="list-style-type: none"> • Press the [F5] key on the keyboard of the personal computer to request that the settings be acquired. <p>[When using Mac]</p> <ul style="list-style-type: none"> • Press the [Command] + [R] keys on the keyboard of the personal computer to request that the settings be acquired. 	<p>—</p>
	<ul style="list-style-type: none"> • Follow the steps below to delete the temporary Internet files (Cache). <p>[When using Windows]</p> <ol style="list-style-type: none"> ① In Internet Explorer, select [Tools] → [Internet Options]. ② Click the [General] tab, and click the [Delete...] button in “Browsing history”. ③ In the [Delete Browsing History] dialog box, set the check box of “Temporary Internet files” to ON, and click the [Delete] button. ④ Click the [OK] button. <p>[When using Mac]</p> <ol style="list-style-type: none"> ① In Safari, select [Safari] → [Empty Cache...]. ② Click the [Empty] button in “Are you sure you want to empty the cache?” pop-up. 	<p>—</p>
	<p>[When using Windows]</p> <ul style="list-style-type: none"> • If “Every time I visit the webpage” is not selected for “Check for newer versions of stored pages” in the Temporary Internet Files settings, the web setting screen may not be displayed properly. <p>→ Follow the steps below.</p> <ol style="list-style-type: none"> ① In Internet Explorer, select [Tools] → [Internet Options]. ② Click the [General] tab, and click the [Settings] button in “Browsing history”. ③ In the [Temporary Internet Files and History Settings] dialog box, under “Check for newer versions of stored pages”, set the radio button to ON for [Every time I visit the webpage]. ④ Click the [OK] button. 	<p>—</p>
	<ul style="list-style-type: none"> • The unit’s ports may be filtered by the firewall or other function of the anti-virus software. <p>→ Change the HTTP port number of the unit to a port number which will not be filtered.</p>	<p>—</p>
<p>It is not possible to download the files</p>	<p>[When using Windows]</p> <ul style="list-style-type: none"> • Has the file download function been disabled? <p>→ Follow the steps below.</p> <ol style="list-style-type: none"> ① In Internet Explorer, select [Tools] → [Internet Options]. ② Click the [Security] tab, and click the [Custom level...] button in “Security level for this zone”. ③ In the [Security Settings] dialog box, under “File download”, set the [Enable] radio button to ON. ④ <For Internet Explorer 8 only> Set the [Enable] radio button of “Automatic prompting for file downloads” to ON. ⑤ Click the [OK] button. ⑥ Click the [OK] button. 	<p>—</p>

Troubleshooting (continued)

Symptom	Cause and remedial action	Reference pages
The authentication screen appears repeatedly	<ul style="list-style-type: none"> ● Has the user name or password been changed? → If you change the user name and password of the user currently logged in from a separate web browser while the unit is being accessed, the authentication screen appears each time the screen display is changed. Close the web browser, and initiate access to the unit again. 	P.101
	<ul style="list-style-type: none"> ● Has the method for user authentication been changed? → If you change the [User auth.] → [Authentication] setting, close the web browser and initiate access again. 	P.101
Screens displays take a while to appear and operations are slower	<ul style="list-style-type: none"> ● Is access being performed in HTTPS mode? Screen displays may take a while to appear in HTTPS mode due to signal processing. 	—
	<ul style="list-style-type: none"> ● Is the unit on the same local network and being accessed via proxy? → Configure the web browser settings so that access is not performed via proxy. 	—
	<ul style="list-style-type: none"> ● Are multiple users accessing the unit's IP videos at the same time? → When multiple users access the unit's IP videos at the same time, image display and operations may take some time to occur, and the refresh speed of the IP videos may drop. 	—
	<ul style="list-style-type: none"> ● Is the H.264 image format set to 1920×1080 (60fps or 50fps)? → Depending on the performance of the personal computer, the screen display images will be displayed later than the actual images if the H.264 image format is set to 1920×1080 (60fps or 50fps). Also, the motion of the screen display images may not be smooth immediately after opening the web screen. 	P.81
The images are not refreshed satisfactorily or they are not displayed	<ul style="list-style-type: none"> ● Reset the Wi-Fi by taking the following steps. [When using a mobile terminal (iOS)] Select [Settings] icon → [General] → [Reset]. Execute [Reset Network Settings], and then establish the new Wi-Fi setting. 	—
H.264 images are not displayed	<ul style="list-style-type: none"> ● Is the camera connected to the personal computer via the Internet? → Set "Internet mode (over HTTP)" to "On". 	P.81
The images break up	<ul style="list-style-type: none"> ● Convergence of transmission lines or some other factor may be making it impossible for the video information to be transmitted properly, causing the images to break up. → Consult with the network administrator. 	—
The screen goes dark when the mobile terminal is left standing for a while	<ul style="list-style-type: none"> ● Is the power-saving function of the mobile terminal set to ON? → Turn the power-saving function of the mobile terminal OFF so that images are displayed at all times. 	—

Troubleshooting (continued)

Symptom	Cause and remedial action	Reference pages
<p>When multiple web browsers are running to display H.264 images, images from multiple cameras appear sequentially in a single web browser.</p>	<p>[When using Windows]</p> <ul style="list-style-type: none"> ● This may occur depending on the combination of the personal computer's display adapter and the driver. → If this occurs, update the first display adapter to the latest version. If this does not resolve the problem, adjust the hardware accelerator function as follows. This section describes the procedure for Windows 7 as an example. Changing the settings may not be possible, depending on your environment. <ol style="list-style-type: none"> ① Right-click on the desktop, and select [Screen Resolution] from the menu. ② Click [Advanced settings]. ③ Select the [Troubleshoot] tab, and click [Change setting]. ④ If the [User Account Control] dialog box appears, click [Yes]. (When logged on with an account other than an administrator account, enter the password (and user name if necessary), and click [Yes].) ⑤ Change to [Hardware acceleration] setting to [None] at the far left, and click [OK]. 	<p>—</p>
<p>An unnecessary status bar or scroll bar is displayed on the pop-up window</p>	<ul style="list-style-type: none"> ● Open the security settings screen for Internet Explorer, and select [Internet]. Click the [Custom level] button, set [Allow script-initiated windows without size or position constraints] to [Enable] under [Miscellaneous], and click the [OK] button. When the warning window appears, click the [Yes] button. 	<p>—</p>
<p>The images do not fit the frame used for display</p>	<ul style="list-style-type: none"> ● If a setting more than 120 DPI has been selected as the image DPI setting, the images may not be displayed correctly. → Right-click on the desktop of the personal computer, click [Screen Resolution] → [Make text and other items larger or smaller], and select [Smaller - 100% (default)]. 	<p>—</p>
	<ul style="list-style-type: none"> ● If a setting other than 100% has been selected as the magnification level used for the zoom function of Internet Explorer, the images may not be displayed properly. → Select [View] → [Zoom] in the menu bar of Internet Explorer, and click [100%]. 	<p>—</p>
<p>An unnecessary scroll bar is displayed, the layout of the screen is distorted, the screen tabs are not displayed, or some buttons on the screen do not operate</p>	<ul style="list-style-type: none"> ● Select [Tools] - [Compatibility View Settings] in the menu bar of Internet Explorer, disable compatibility view for the unit. 	<p>—</p>

Troubleshooting (continued)

● Web browser settings

Depending on the OS installed on the personal computer, the following may occur. Follow the instructions below when the following has occurred.

By performing the following solutions, other applications and the security level may not be affected.

[When using Windows]

The “information bar” described in the following explanations refers to the message bars that appear in Internet Explorer.

For Internet Explorer 9.0, 10.0, and 11.0:

The information bar appears at the bottom of Internet Explorer.

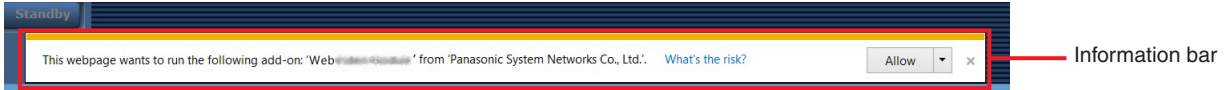

For Internet Explorer 8.0:

The information bar appears under the address bar of Internet Explorer.

Symptom	Cause and remedial action	Reference pages
<p>For Internet Explorer 9.0, 10.0, and 11.0: The following message appears in the information bar. “This website wants to run the following add-on: ‘Web*****’ from ‘Panasonic System Networks Co., Ltd.’.”</p>	<ul style="list-style-type: none"> • Select [Allow]. 	—
<p>For Internet Explorer 8.0: The following message appears in the information bar. “Pop-up blocked. To see this pop-up or additional options click here...”</p>	<ul style="list-style-type: none"> • Click the information bar, and select [Always Allow Pop-ups from This Site]. When the [Allow pop-ups from this site?] dialog box appears, click the [Yes] button. 	—
<p>For Internet Explorer 9.0, 10.0, and 11.0: The following message appears in the information bar. “This website wants to install the following add-on: ‘nwcV4SSetup.exe’ from ‘Panasonic System Networks Co., Ltd.’.”</p>	<ul style="list-style-type: none"> • Select [Install]. When the security warning window appears, click the [Install] button. 	—
<p>For Internet Explorer 8.0: The following message appears in the information bar. “This site might require the following ActiveX control: ‘nwcV4SSetup.exe’ from ‘Panasonic System Networks Co., Ltd.’. Click here to install...”</p>	<ul style="list-style-type: none"> • Click the information bar, and select [Install ActiveX control]. When the security warning window appears, click the [Install] button. 	—

Specifications

Power requirements:

DC \equiv 12 V (Supplied AC adaptor)
DC \equiv 42 V to 57 V (PoE+ power supply)

Current consumption:

1.3 A (Supplied AC adaptor)
0.5 A (PoE+ power supply)

 indicates safety information.

■ GENERAL

Ambient operating temperature:

0 °C to 40 °C (32 °F to 104 °F)

Storage temperature: -20 °C to 50 °C (-4 °F to 122 °F)

Allowable humidity ranges:

20 % to 90 % (no condensation)

Mass: Approx. 1.5 kg (3.30 lb)

Dimensions (W × H × D):

160 mm × 186 mm × 179 mm
(6-5/16 inches × 7-41/128 inches ×
7-3/64 inches)
[excluding protrusions, direct ceiling
mount bracket]

Finish:

[AW-HE42WP, AW-HE42WE] Pearl white
[AW-HE42KP, AW-HE42KE] Metallic black

Controller supported: AW-RP50

■ INPUT

Power: DC 12 V IN,
PoE+ (IEEE802.3at compliant)

Mic/line input: Stereo mini-jack (ø3.5 mm)
Input impedance:
Approx. 2 k Ω (unbalanced)

[Mic input]

Supported microphones:
Stereo mic (plug-in power,
on/off switching via menu)

Supplied voltage:
2.5 V \pm 0.5 V

Mic input level:
-60 dBV \pm 3 dBV
(0 dB=1 V/Pa, 1 kHz)

[Line input]

Input level:
-10 dBV \pm 3 dBV

G/L IN: BBS (Black Burst Sync) signal and
tri-level sync supported (BNC × 1)

■ OUTPUT

Video output

HDMI: HDMI connector
● **HDCP is not supported.**
● **VIERA Link is not supported.**

3G/HD SDI OUT: BNC connector (75 Ω)
Compliant with the SMPTE424M/
Compliant with the SMPTE292M

■ INPUT/OUTPUT

Input/Output connector

LAN: LAN connector for IP control (RJ-45)
Equipped with straight/crossover
cable auto detection function

RS-232C: Mini DIN 8-pin (IN)
Mini DIN 8-pin (OUT)

RS-422: CONTROL IN RS422A (RJ-45)

USB: Mini-B port

SD card: microSD card slot

Specifications (continued)

FUNCTIONS AND PERFORMANCE

[Camera unit]

Imaging sensors: 1/2.3-type MOS

Lens: Motorized 20x zoom, F1.8 to F3.6
[f=4.08 mm (5/32 inches) to 81.6 mm (3-7/32 inches); 35 mm (1-3/8 inches) equivalent: 29.5 mm (1-5/32 inches) to 612.0 mm (24-3/32 inches)]

View angle: During OIS OFF or OIS Mode1:
Horizontal:
65.1° (Wide) to 3.2° (Tele)
Vertical:
39.5° (Wide) to 1.8° (Tele)
Diagonal:
72.4° (Wide) to 3.7° (Tele)
During OIS Mode2:
Horizontal:
59.6° (Wide) to 2.9° (Tele)
Vertical:
35.7° (Wide) to 1.6° (Tele)
Diagonal:
66.6° (Wide) to 3.4° (Tele)

Focus: Switching between auto and manual

Focus distance: Entire zooming range:
1.5 m (4.9 ft)
Wide end: 10 cm (0.33 ft)

Color separation optical system:
On-chip color filter system

Minimum illumination:

59.94 Hz	0.7 lx (50 IRE, F1.8, 48 dB, 1/60 without accumulation) 0.35 lx (50 IRE, F1.8, 48 dB, 1/30 with accumulation [Frame Mix 6 dB])
50 Hz	0.7 lx (50 IRE, F1.8, 48 dB, 1/50 without accumulation) 0.35 lx (50 IRE, F1.8, 48 dB, 1/25 with accumulation [Frame Mix 6 dB])

Horizontal resolution: 1000 TV lines Typ (Center area)

Gain selection: Auto, 0 dB to 48 dB (3 dB step)
● During Auto, 6 dB to 48 dB (6 dB step) are available for AGC Max Gain setting.

Frame mix: Auto, Off, 6 dB, 12 dB, 18 dB, 24 dB
● During Auto, 0 dB, 6 dB, 12 dB and 18 dB are available for Auto F.Mix Max Gain setting.

ND filter: Auto, Through, 1/4, 1/16, 1/64
● “Auto” can be selected when “Scene” is set to “Full Auto”.

Electronic shutter speed:

During Full Auto:

59.94 Hz	1/60 to 1/2000 (Auto Slow Shutter: Off) 1/30 to 1/2000 (Auto Slow Shutter: On)
50 Hz	1/50 to 1/2000 (Auto Slow Shutter: Off) 1/25 to 1/2000 (Auto Slow Shutter: On)

During Auto:

59.94 Hz	1/60 to 1/2000
50 Hz	1/50 to 1/2000

During Manual:

59.94 Hz	1/100, 1/250, 1/500, 1/1000, 1/2000, 1/4000, 1/10000
50 Hz	1/120, 1/250, 1/500, 1/1000, 1/2000, 1/4000, 1/10000

Syncro scan:

59.94 Hz	59.94 Hz to 660.09 Hz (255 step)
50 Hz	50.00 Hz to 570.12 Hz (255 step)

Gamma: Off, Normal (Low, Mid, High), Cinema

White balance: ATW, AWB A, AWB B, 3200K, 5600K, VAR (2400K to 9900K)

Chroma amount variability:
±3 step

Scene file: Full Auto, Manual1, Manual2, Manual3

Output format:

HD	1080: 59.94p/50p 1080: 59.94i/50i 1080: 29.97p/25p 1080: 29.97PsF/25PsF 720: 59.94p/50p
-----------	---

Synchronization system:

Internal synchronization/
External synchronization
(BBS, Tri-level sync)

Image stabilization: O.I.S.
4-Axis Hybrid Image Stabilizer

Specifications (continued)

[USB connection]

- This may vary depending on the operating environment.

Video output: USB Video Class Ver1.0

Video compression format:
Motion JPEG

Audio output: USB Audio Class Ver1.0

Audio compression format:
Linear PCM, 48 kHz, 16-bit,
2 channels

Transfer modes:

Image	Resolution	Frame rate*1	
		System frequency 59.94 Hz	System frequency 50 Hz
JPEG	1920×1080	30fps	25fps
	1280×720	15fps	12.5fps
	640×360	5fps	5fps

*1: The frame rate may be lower than the setting depending on the operating conditions.

Supported models: Devices standardly equipped with a USB 2.0 compatible port

[Pan-tilt head unit]

Installation method: Stand-alone (Desktop) or suspended (Hanging)

- To ensure safety, the unit must be secured using the mount bracket supplied.

Camera/pan-tilt head control:

IP connecting cable	When connecting through a hub: LAN cable*2 (category 5 or above), max. 100 m (328 ft) When using a PoE+ hub: LAN cable*2 (category 5e or above), max. 100 m (328 ft) When a hub is not used: LAN cable*2 (category 5 or above), max. 100 m (328 ft)
AW protocol connecting cable	LAN cable*2 (category 5 or above, straight cable), max. 1000 m (3280 ft)
Standard protocol connecting cable	Mini DIN 8-pin cable, male

*2: Use of an STP (shielded twisted pair) cable is recommended.

Pan/tilt operation speed:

Maximum speed during preset:
300°/s
Maximum speed during manual:
90°/s

Panning range: ±175°

Tilting range: -30° to 90°

- Depending on the pan or tilt position, the camera may be reflected in the image.

Quietness: During preset: NC40 or less
During manual: NC35 or less

Specifications (continued)

[SD card recording/Video recording]

MPEG-4 AVC file standard compliant (.MP4)

Video compression format:

MPEG-4 AVC/H.264 High Profile

Audio compression format:

AAC-LC (48 kHz, 16 bit, 2 ch, 128 kbps)

Recording format / Bit rate		
System frequency 59.94 Hz	System frequency 50 Hz	Bit rate
1920×1080/59.94p	1920×1080/50p	Up to 28 Mbps
1920×1080/29.97p	1920×1080/25p	Average 15 Mbps
		Average 10 Mbps
		Average 6 Mbps
1280×720/59.94p	1280×720/50p	Average 15 Mbps
1280×720/29.97p	1280×720/25p	Average 8 Mbps
		Average 4 Mbps
		Average 2 Mbps
		Average 1 Mbps

[SD card recording/Still image recording]

Recording system: JPEG (The resolution recorded will be the same as the JPEG stream with the lowest number.)

Maximum number of recordable items:

99

[Network]

Transfer modes:

Image	Resolution	Frame rate*1	
		System frequency 59.94 Hz	System frequency 50 Hz
JPEG	1920×1080	30fps 15fps 5fps	25fps 12.5fps 5fps
	1280×720		
	640×360		
	320×180		
H.264	1920×1080	60fps*2 30fps 15fps 5fps	50fps*2 25fps 12.5fps 5fps
	1280×720		
	640×360		
	320×180		

*1: The frame rate may be lower than the setting depending on the operating conditions.

*2: When the image resolution is "640×360" or "320×180", 60fps or 50fps cannot be selected for the frame rate.

Supported protocol:

IPv4	TCP/IP, UDP/IP, HTTP, HTTPS, RTSP, RTP, RTP/RTCP, FTP, DHCP, DNS, NTP, IGMP, UPnP, ICMP, ARP, RTSPoverTCP, RTSPoverHTTP, SSL(TLS), MultiCast/UniCast
IPv6	TCP/IP, UDP/IP, HTTP, HTTPS, RTSP, RTP, RTP/RTCP, FTP, DHCPv6, DNS, NTP, ICMPv6(MLD), RTSPoverTCP, RTSPoverHTTP, SSL(TLS), MultiCast/UniCast

i-OS, Android support:

JPEG image display

Specifications (continued)

■ AC adaptor

Input: AC \sim 100 V to 240 V, 1.2 A, 50/60 Hz

Output: DC \equiv 12 V, 3.0 A, 36 W

 indicates safety information.

Mass: Approx. 220 g (0.485 lb)

Dimensions (W × H × D):

115 mm × 37 mm × 57 mm
(4-17/32 inches × 1-59/128 inches ×
2-31/128 inches)

Inrush current, measured according to European standard EN55103-1, on initial switch-on: 4.5 A, after a supply interruption of 5 s: 16 A

Index

Numerics

16-axis color matrix 53

A

AC adaptor (Supplied) 15, 155
Access level 101, 102
Activate 123
Activation 102
Activation counter 120
Advanced 107
AGC Max Gain 48, 90
ALC 61, 87
Aperture (Iris) 129
Audio 61, 87
Audio bit rate 87
Audio button 73
Audio Input Mixer Properties 130
Audio over IP 87
Audio Transmission 87
Authentication 101
Auto F.Mix Max Gain 48, 89
Automatic adjustment (AWB) 39
Automatic installation of viewer software 78
Auto port forwarding 109
Auto Shutter Limit 47, 89
Auto Slow Shutter 46, 88
Auto tracking white adjustment (ATW) 41
AWB 90
AW-RM50G 15, 18

B

Backlight Comp 128
Back Light COMP. 52, 93
Backup 122
Bandwidth control (bitrate) 105
Bars Title 99
Bars Type 60, 99
Basic 77
B Gain 50, 91
Bracket mounting screws 15
Brightness 72, 94, 128
B to Cy_B_B
 Phase 53, 93
 Saturation 53, 93

C

Cable clamp 20
CA Certificate
 CA Certificate install 110, 115
 Generate Certificate Signing Request 110, 114
 Information 110
CAM/BAR 60, 99
Camera 45
Camera Control 129
Camera menu 134
Camera screen 46, 47
Camera title 78, 100
Camera title display area 73
Changing the format 57
Changing the frequency 57
Chroma amount variability 152
Chroma Level 50, 90
Color Enable 128
Color Matrix 93

Color Temperature 50, 91
Common 105
Compression 70
Concerning initialization 63
Config data type 122
Connected device indication 73
Connection 110, 116
Contrast 47, 88, 128
Contrast 1/2 screen 47
Contrast 2/2 screen 48
Contrast Level 46, 47, 88
Contrast Mode 47, 88
Controller 151
Control pad and its buttons 72, 95
Control port 107
CRT key generate 109, 112

D

Date & Time 119
Date&Time 77
Day/Night 46, 49, 90
Default gateway 103, 104
Default Gateway 63
Default reset 121
Description 119
Destination IP address(1) 102
Destination IP address(2) 102
Detail 51, 91
Detail Level H 51, 91
Detail Level L 51, 91
D.Extender 59, 98
D.Extender Magnification 59, 98
DHCP 103
DHCPv6 104
Direct ceiling mount bracket 15
Directory name 107
Display 77
DNR 52, 92
DNS 104
Download 122, 123
Drop-prevention wire 15, 19
DRS 51, 92

E

Easy IP Setup accommodate period 105
Easy IP Setup Software 25
E.DRS 52, 92
Electronic shutter speed 152
Enable 130
Equalizer 61, 87
Error code 119
Error description 119
Error log 119
Event code 119
Event log 119
Exposure 129

F

Firmware file 120
Firmware version 120
Firmware Version 62
Firmware Version screen 62
Flesh Tone Mode 51, 91
Focus 72, 94, 129, 133

Index (continued)

Focus ADJ With PTZ	58, 95, 98
Focus Mode	58, 98
Format	55, 79
Format (HDMI)	97
Format (SDI)	97
Frame mix	152
Frame Mix	48, 89
Frame rate	82
Freeze During Preset	58, 98
Frequency	55, 97
FTP	107
FTP mode	107
FTP server address	107
Full-screen display button	73

G

Gain	48, 89, 128
Gain selection	152
Gamma	128, 152
Gamma Level	52, 92
Gamma Type	52, 92
Genlock	54, 96
Genlock screen	54

H

H.264(1) • H.264(2) • H.264(3) • H.264(4)	81
H.264 transmission	81
HDMI	55
HDR	51, 91
Horizontal Phase	54, 96
Horizontal Phase Step	54
Host auth.	102
Host check	102
HTTP max segment size(MSS)	105
HTTP port	105
HTTPS	109, 111, 116
HTTPS port	110
Hue	128

I

Image adjust	88
Image/Audio	80
Image capture size	81, 82
Image/Position	88
Image quality	81, 83
Image Save	96
Image stabilization	152
Initial display settings for "Live" page	80
Initialize	62, 63
Input Volume	61, 87
Install Position	58, 97
Internet mode (over HTTP)	81
IP address	25, 100, 102
IP Address	63
IP address(IPv4)	103
IP address(IPv6)	104
IP Network	62
IP Network screen	63
IPv4 network	103
IPv6 network	104
IR Control	60, 99
IR ID	60, 99
Iris	133

J

JPEG	81, 86
JPEG(1) • JPEG(2) • JPEG(3)	81
JPEG transmission	81

L

LAN cable	20
Limitation Setting	95
Live	68, 69, 74
Live page	78
Live screen	68, 69, 74
Low Light Compensation	129

M

MAC address	120
Main area	72, 76
Maintenance	45, 119
Maintenance screen	62
Main unit mounting screw	15
Manual	104
Manual adjustment (R gain and B gain adjustment)	42
Manual - Date/time	77
Manual - End time & date	78
Manual - Start time & date	78
Manual - Summer time (daylight saving)	78
Manual - Time zone	77
Matrix	47
Matrix Type	53
Max bit rate (per client)	82
Max Digital Zoom	59, 98
Max RTP packet size	105
Model no.	120
Model Select	99
Mount bracket	15, 19
Multicast address	84
Multicast port	84
Multicast TTL/HOPLimit	84
Multi display mode	74
Multi-screen	70, 74, 100
Multi-screen setup	100

N

ND filter	152
ND Filter	46, 48, 90
Network	103
Night-Day Level	46, 49, 90
No	119
NTP	77, 108
NTP port	108
NTP server address	108
NTP server address setting	108

O

OIS	59, 98
Operation time	119, 120
Op. Lock	71
OSD Menu Operation	71
OSD Mix	99
OSD Off With Tally	60, 99
OSD Status	60, 99
OSS license display	120
Other Menu	70

Index (continued)

Others	54, 97
Others 1/4 screen	58
Others 2/4 screen	59
Others 3/4 screen	60
Others 4/4 screen	61
Output	54, 97
Output format	152
Output screen	55

P

Pan	129, 131
Pan / Tilt / Lens Control	94
Password	101, 107
PC synchronization	77
Pedestal	50, 92
Picture	47, 90
Picture 1/3 screen	50
Picture 2/3 screen	51
Picture 3/3 screen	52
Play List	126
Plugin Power	61, 87
PoE+	14
Port number(HTTP)	121
Port number(HTTPS)	121
Power cable	15
Power Line Frequency (Anti Flicker)	128
Power ON	71, 76
Preset	73, 94, 132
Preset memories	38
Preset position	88, 94
Preset Scope	58, 95, 97
Preset Setting	95
Preset Speed	58, 95, 97
Preset Speed Table	58, 95, 97
Primary DNS server address	104
Primary server address	104
Priority mode	77
Priority Mode	30, 56, 77
Priority stream	102
Product info.	120
Protocol	99
Protocol Model Select	61

R

Reboot	121
Recommended network setting for internet	106
Recording format	79
Recording setting	79
Record tally	79
Refresh interval	81
Remaining capacity	79
Reset to the default (Except the network settings)	121
Resolution	132
Retype password	101
R Gain	50, 91
Roll	129
Router global address	121

S

Saturation	128
Scene	46, 73, 88
Scene file	152
SD access lamp	73
SD Card Operation	71
SDI	55

SD memory card	79
SD memory card information	79
Secondary DNS server address	104
Secondary server address	104
Security certificate	117
Self-signed Certificate	
Generate	109, 113
Information	109
Serial no.	120
setup	77
Setup	44, 68, 75, 76
Sharpness	128
Shutter Mode	47, 89
Shutter speed	37, 48, 89
Single display mode	69
Smoother live video display on the browser (buffering)	78
Snapshot button	73
Speed	72, 95
Speed With Zoom POS.	58, 95, 98
Standby	71, 76
Status	121
Step/Synchro	48
Stream	70, 80
Stream Menu	70
Stream type	102
Subnet mask	103
Subnet Mask	63
Synchronization system	152
Synchronization with NTP	108
Synchro scan	152
System	45, 96
System log	119
System screen	54

T

Tally	59, 99
Tally lamp	134
Tilt	129, 131
Time adjustment interval	108
Top Menu	45
Top Menu screen	45
Transmission priority	82
Transmission type	84

U

Unicast port(Audio)	84
Unicast port(Image)	84
Upload	122, 123
UPnP	109, 121
USB Vol. Control	61, 87
User auth.	101
User check	101
User Color Matrix Setup screen	93
User mng.	101
User name	101, 107

V

Video over IP	80
Video Proc Amp	128

W

Web screen	67
Web setup screen	68, 75, 76

Index (continued)

White balance	152
White Balance	128
White Balance Mode	50, 91
Wireless remote controller	15, 18, 22, 24
WV-Q105A	15

Z

Zoom	72, 94, 129, 131
Zoom Mode	59, 98

Panasonic Corporation

Web Site: <http://www.panasonic.com>

© Panasonic Corporation 2019